

2021-2022

School Supplies & Furniture



forwardproducts.co.uk

School Supplies & Furniture



Based in Bromsgrove, North Worcestershire, Forward Products is a family run business which has specialised in educational supplies since 1999. We aim to help you reduce hassle, cut costs and save time when purchasing your school supplies. This includes:

1. An enthusiastic and knowledgeable sales team
2. Accurate order processing and picking
3. A fast delivery service
4. Helpful and friendly delivery drivers



Forward Furniture are experienced in the supply and installation of furniture for schools, universities and offices. From classrooms and breakout areas through to boardrooms and executive suites, our expertise in interior solutions ensures you get the furniture you want, in the way you want, at the price you need!

Tel: 01527 878348

Email: sales@forwardproducts.co.uk

Web: forwardproducts.co.uk

Post: Redcliffe House, Sherwood Rd, Bromsgrove, B60 3DR



Follow us @ForwardProducts



John Knight Interiors is the sister company to Forward Products. If your furniture requirement entails fitted furniture and project management, John Knight Interiors have the expertise to support you through every phase of your project. Whether it be a science laboratory, food tech room, school library and teaching walls that you require, please contact us today to discuss your needs in more detail with one of our friendly furniture experts.

Contents

Exercise Books	4-29
Copy Papers	30-37
Print & Personalisation	38-43
Stationery	44-161
Office Machines	162-181
Art & Craft	182-229
Display	230-253
Facilities & Hygiene	254-302
Furniture	303-570
Index	571-583



Returns

To arrange the return of any item, please call customer services on 01527 878348 within 48 hours of receiving your delivery. All goods must be returned in a saleable condition. Returned items which have been delivered direct may incur a re-stocking charge so please take extra care when ordering such items. Food products are non returnable.



Carriage Terms

All orders within our Midlands catchment area are delivered free of charge; charges may apply to deliveries further afield. We do not have a minimum order value.



Environmental Policies

We take our share of responsibility in caring for the environment. That's why many of the products in this catalogue are produced from recycled materials; look out for the familiar symbol. We source copy paper from sustainable sources. Even this catalogue is produced from FSC accredited paper!



Terms and Conditions

We extend automatic credit accounts to local authority sponsored organisations. Terms of payment are 28 days following date of invoice. All prices are net and subject to VAT unless otherwise stated. Prices are correct at time of printing and are subject to change without notice. Goods are offered subject to availability and are supplied subject to our full terms and conditions, a copy of which is available on request.

QUICK INDEX GUIDE

This quick index guide lists only the most popular products. Our main index is split into school supplies and furniture. The full School Supplies index starts on page 570 and the Furniture on page 566

A4 PAPER	31-36	FOLDING CHAIRS	320	PUNCHES, HOLE	157-158
ACADEMIC DIARIES	54	GEORAMA METALLIC PAPER	37	PVA GLUE	226
ADHESIVES	147-151,226-229	GLUE STICKS	147,148,227,228	QUICKSTICKS	148,228
BALLPOINT PENS	83-84	GRATNELL'S STORAGE UNITS	356	READY MIXED PAINT	197-199
BATTERIES	159	GRATNELL'S TRAYS	136	REFUSE SACKS	285
BESPOKE EXERCISE BOOKS	23-24	HAND SOAP	273,282	RING BINDERS	113,117
BIN BAGS	285	HAND TOWELS	293	RUBBER BANDS	144,146
BIN LINERS	285	HANDWRITING PENS	80-82	RULERS	110
BLACK SACKS	285	HB PENCILS	71-72,211-212	SCISSORS	152
BLEACH	291-292	HIGHLIGHTER PENS	91-92	SELLOTAPE	150
BLU-TACK	151,229	HOLE PUNCHES	157-158	SEN EXERCISE BOOKS	13
BOOKCASES	360,369,372,374,390,501,504,529	HYGIENE PAPERS	293-296	SHREDDERS	173-174
BORDER ROLLS	191-195	ICE PACKS	259	SICK BAGS	260
CALCULATORS	111	IT CHAIRS	321-322	SKETCH BOOKS	26,59,207
CHAIRS	309-329,388,427-450	JUMBO PENCILS	71,74,211,213	SOAP	273,282
CHILDRENS DRYWIPE PENS	95-96	KASKAD PAPER & CARD	35-36,187-188	STAPLERS & STAPLES	153-155
CLASSROOM CHAIRS	309-322,388	KITCHEN ROLL	296	STEP LADDERS	301
CLASSROOM STOOLS	323-328	LAMINATING POUCHES	45-46,164-165	STICKY NOTES	67-69
CLASSROOM TABLES	330-353	LAMINATORS	163-164	STOOLS	309,310,323-327,462,548,558
COFFEE	297	LASER LABELS	50,52	STORAGE, OFFICE	490,499-505,529-540
COLOURED PAPER & CARD	35-36,185,187-188	LETTER TRAYS	137-140	STORAGE TRAY UNITS	355-368,371,373-383
COLOURING PENCILS	73-75,213-214	LETTERHEADS	40	STRING	49
COMPLIMENT SLIPS	40	LEVER ARCH FILES	114	SUBJECT DIVIDERS	125-126
COPIER LABELS	50	LIQUID HAND SOAP	273,282	SUGAR	297
COPIER PAPER	31-36	LOGO MATS	42	SUGAR PAPER	183,193
CREPE PAPER	186	MANAGER CHAIRS	439-440	TABLES, CLASSROOM	331-351,387-389
CUPBOARDS	360,364,370,372,502-505,529-540	MILK POTS	298	TABLES, OFFICE	473-483,487-489,507-522,526-527
CUPS	298	MINI DRYWIPE PENS	95-96	TACKERS	156
DESKS	348-351,473-482,487-489	MINI WHITEBOARDS	100-107	TASK CHAIRS	430,433-439,442
DIARIES	54	MODULAR CHAIRS	453-455,463-465	TEA BAGS	297
DISINFECTANT	269, 280,291,292	MOTIVATIONAL STICKERS	51	TEACHER DESKS	350
DISPLAY PAPER & ROLLS	189-193	NOTEBOOKS	11,27-28,55-57	TEACHER PLANNERS	53
DISPOSABLE GLOVES	268	NOTICEBOARDS	245-252	TINTED PAPER & CARD	35-36,185,187-188
DISPOSABLE PLATES	298	OFFICE CHAIRS	425-442	TISSUE PAPER	186
DIVIDERS	125-126	OFFICE DESKS	473-483,487-489,526-527	TITAN CHAIRS	311,312,322,327
DOCUMENT WALLET	120,122	OPERATOR CHAIRS	427-432	TOILET CLEANERS	291-292
DRINKING CUPS	298	PAINT BRUSHES	203-204	TOILET ROLLS	295-296
DRYWIPE MARKERS	88,92-93,243-244	PAPER PLATES	298	TRACING PAPER	196
EN CHAIRS	313-314	PEDESTALS	485-486,528,530,538	TRAINING TABLES	509-512
ENVELOPES	47-48	PENCIL SHARPENERS	76-77,144	WATER BOTTLES	43
ERASERS	78	PENCILS	71-75,211-214	WATERCOLOUR TABLETS	200
ESSENTIALS TUBS	143-144	PLASTERS	258	WHITE CARD	34,184
EXAM DESKS	351	POLYPROPYLENE CHAIRS	310-319,321-322	WHITE PAPER	31-34
EXERCISE BOOKS	5-24	POSTER PAPER	183,190	WHITEBOARDS	100-108,235-242
EXERCISE PAPER	29	POST-IT NOTES	68-69	ZIP WALLETS	112
FACIAL TISSUES	296	POSTURA PLUS CHAIRS	310		
FELT TIP PENS	89-90,215-216	PRESENTATION RING BINDERS	117		
FILING CABINETS	504,528-529,533-534,540	PRITT STICKS	147,227		
FIRST AID KITS	255-257	PROSPECTUS FOLDERS	40		
FLIPCHART EASELS	231-232	PROJECT BOOKS	27,28,56		
FLIPCHART PADS	233	PUNCHED POCKETS	116		



01

EXERCISE BOOKS

Classic Exercise Books

5-18

- Manufactured in the EU
- 100% recyclable, solvent free, water based ink
- 75 gsm paper pages sourced from sustainably managed forests
- Strong manilla 225 gsm card covers made from 100% recycled material
- Next day delivery available
- Have your books plain or overprinted Free Of Charge!



Oxford Exercise Books

19-22

- Popular quality Oxford books with premium glossy covers and unique matt writing panel
- Vibrant 250gsm varnished covers give the books a smarter look and added protection
- Have your books plain or overprinted with your school logo Free of Charge!



MyChoice Bespoke Exercise Books

23-24

- Our most popular range of bespoke exercise books
- Laminated covers available for extra durability
- Many other features accommodated including full cover colours, internal page printing, tinted pages and bespoke rulings
- Any cover colour and ruling combination available



Accessories

25-29

- Book Covering Film & Book Jackets
- Sketch Books
- Project Books and Scrap books
- Notebooks
- Filing
- Exercise Papers



classic

Bright white bleed
proof internal pages



Brighter range
of colours

A4+ Exercise Books 80 Pages (320 x 240mm) Pack of 45

Code	Ruling	Colour	
EOS80FRD	8mm Feint & Margin	Red	£27.45
EOS80FPU	8mm Feint & Margin	Purple	£27.45
EOS80FYW	8mm Feint & Margin	Yellow	£27.45
EOS80FLB	8mm Feint & Margin	Light Blue	£27.45
EOS80FLG	8mm Feint & Margin	Light Green	£27.45
EOS80FOR	8mm Feint & Margin	Orange	£27.45
EOS80FPK	8mm Feint & Margin	Pink	£27.45
EOS8012FRD	12mm Feint & Margin	Red	£27.45
EOS8012FPU	12mm Feint & Margin	Purple	£27.45
EOS8012FYW	12mm Feint & Margin	Yellow	£27.45
EOS8012FLB	12mm Feint & Margin	Light Blue	£27.45
EOS8012FLG	12mm Feint & Margin	Light Green	£27.45
EOS8012FOR	12mm Feint & Margin	Orange	£27.45
EOS808RD	8mm Feint	Red	£27.45
EOS808LB	8mm Feint	Light Blue	£27.45
EOS8015LB	15mm Feint	Light Blue	£27.45
EOS80BRD	Blank	Red	£27.45
EOS80BPU	Blank	Purple	£27.45
EOS80BYW	Blank	Yellow	£27.45
EOS80BLB	Blank	Light Blue	£27.45
EOS80BLG	Blank	Light Green	£27.45
EOS805OR	5mm Squares	Orange	£27.45
EOS805LB	5mm Squares	Light Blue	£27.45
EOS807YW	7mm Squares	Yellow	£27.45
EOS807LB	7mm Squares	Light Blue	£27.45
EOS8010YW	10mm Squares	Yellow	£27.45
EOS8010LB	10mm Squares	Light Blue	£27.45
EOS8010RD	10mm Squares	Red	£27.45
EOS8010PU	10mm Squares	Purple	£27.45
EOS8010LG	10mm Squares	Light Green	£27.45

A4+ Exercise Books 48 Pages (320 x 240mm) Pack of 45

Code	Ruling	Colour	
EOS48FRD	8mm Feint & Margin	Red	£22.25
EOS48FPU	8mm Feint & Margin	Purple	£22.25
EOS48FYW	8mm Feint & Margin	Yellow	£22.25
EOS48FLB	8mm Feint & Margin	Light Blue	£22.25
EOS48FLG	8mm Feint & Margin	Light Green	£22.25
EOS48BRD	Blank	Red	£22.25
EOS48BYW	Blank	Yellow	£22.25
EOS48BLG	Blank	Light Green	£22.25
EOS48BPU	Blank	Purple	£22.25
EOS48BLB	Blank	Light Blue	£22.25
EOS4810LB	10mm Squares	Light Blue	£22.25
EOS4810YW	10mm Squares	Yellow	£22.25



A4 Exercise Books 80 Pages
(210 x 297mm)
Pack of 50

Code	Ruling		
EA480FRD	8mm Feint & Margin	Red	£19.45
EA480FPU	8mm Feint & Margin	Purple	£19.45
EA480FYW	8mm Feint & Margin	Yellow	£19.45
EA480FLB	8mm Feint & Margin	Light Blue	£19.45
EA480FDB	8mm Feint & Margin	Dark Blue	£19.45
EA480FLG	8mm Feint & Margin	Light Green	£19.45
EA480FDG	8mm Feint & Margin	Dark Green	£19.45
EA480FOR	8mm Feint & Margin	Orange	£19.45
EA480FPK	8mm Feint & Margin	Pink	£19.45
EA480FBU	8mm Feint & Margin	Buff	£19.45
EA480FGY	8mm Feint & Margin	Grey	£19.45
EA4806RD	6mm Feint & Margin	Red	£19.45
EA4808LB	8mm Feint	Light Blue	£19.45
EA4805LB	5mm Squares	Light Blue	£19.45
EA4805OR	5mm Squares	Orange	£19.45
EA4805RD	5mm Squares	Red	£19.45
EA4805YW	5mm Squares	Yellow	£19.45
EA4807YW	7mm Squares	Yellow	£19.45
EA4807LB	7mm Squares	Light Blue	£19.45
EA4807DB	7mm Squares	Dark Blue	£19.45
EA4807OR	7mm Squares	Orange	£19.45
EA48010YW	10mm Squares	Yellow	£19.45
EA48010LB	10mm Squares	Light Blue	£19.45
EA48010OR	10mm Squares	Orange	£19.45
EA48010RD	10mm Squares	Red	£19.45
EA480BYW	Blank	Yellow	£19.45
EA480BDB	Blank	Dark Blue	£19.45
EA480BPK	Blank	Pink	£19.45
EA480BRD	Blank	Red	£19.45
EA480FADG	8mm Feint / Alt Blank	Dark Green	£19.45
EA480FARD	8mm Feint / Alt Blank	Red	£19.45
EA480FAPU	8mm Feint / Alt Blank	Purple	£19.45
EA480FA12RD	12mm Feint / Alt Blank	Red	£19.45



A4 Rhino Toughback 120 Page Exercise Books

- Premium quality exercise books
- Extra thick, wipeable covers
- Smart, flexible dark blue covers
- Perfect for use in science labs or food tech rooms

Code	Ruling	Size	Packed	
ERTA4	8mm Feint & Margin	A4	6	£16.86



classic

A wide range of rulings
& colours available



Bleed proof pages
for superior quality

Now available
with your logo
overprinted - see
pages 14-18 for
details ...

A4 Exercise Books 64 Pages
(210 x 297mm)
Pack of 50

Code	Ruling	Colour	
EA4646FLB	6mm Feint & Margin	Light Blue	£18.67
EA4646FRD	6mm Feint & Margin	Red	£18.67
EA464FRD	8mm Feint & Margin	Red	£18.67
EA464FPU	8mm Feint & Margin	Purple	£18.67
EA464FYW	8mm Feint & Margin	Yellow	£18.67
EA464FLB	8mm Feint & Margin	Light Blue	£18.67
EA464FDB	8mm Feint & Margin	Dark Blue	£18.67
EA464FLG	8mm Feint & Margin	Light Green	£18.67
EA464FDG	8mm Feint & Margin	Dark Green	£18.67
EA464FOR	8mm Feint & Margin	Orange	£18.67
EA464FPK	8mm Feint & Margin	Pink	£18.67
EA464FBU	8mm Feint & Margin	Buff	£18.67
EA46412PU	12mm Feint & Margin	Purple	£18.67
EA464612RD	12mm Feint & Margin	Red	£18.67
EA464612YW	12mm Feint & Margin	Yellow	£18.67
EA464612LB	12mm Feint & Margin	Light Blue	£18.67
EA464612LG	12mm Feint & Margin	Light Green	£18.67
EA464612OR	12mm Feint & Margin	Orange	£18.67
EA464615LB	15mm Feint & Margin	Light Blue	£18.67
EA464615OR	15mm Feint & Margin	Orange	£18.67
EA464615PU	15mm Feint & Margin	Purple	£18.67
EA464615RD	15mm Feint & Margin	Red	£18.67
EA464615YW	15mm Feint & Margin	Yellow	£18.67
EA46415LB	15mm Feint	Light Blue	£18.67
EA4645LB*	5mm Squares	Light Blue	£18.67
EA4647YW	7mm Squares	Yellow	£18.67
EA4647LB	7mm Squares	Light Blue	£18.67
EA46410YW	10mm Squares	Yellow	£18.67
EA46410LB	10mm Squares	Light Blue	£18.67
EA46410LG	10mm Squares	Light Green	£18.67
EA46420LB	20mm Squares	Light Blue	£18.67
EA464BRD	Blank	Red	£18.67
EA464BYW	Blank	Yellow	£18.67
EA464BLB	Blank	Light Blue	£18.67
EA464BLG	Blank	Light Green	£18.67
EA464BBU	Blank	Buff	£18.67
EA464FARD	8mm Feint/Alt. Blank	Red	£18.67
EA464FALG	8mm Feint/Alt. Blank	Light Green	£18.67
EA464FAYW	8mm Feint/Alt. Blank	Yellow	£18.67
EA464FALB	8mm Feint/Alt. Blank	Light Blue	£18.67
EA464BFLG	Top Blank/Bottom 15mm Ft	Light Green	£18.67

*While stocks last

A4 Exercise Books 48 Pages
(210 x 297mm)
Pack of 100

Code	Ruling	Colour	
EA448FRD	8mm Feint & Margin	Red	£32.87
EA448FPU	8mm Feint & Margin	Purple	£32.87
EA448FYW	8mm Feint & Margin	Yellow	£32.87
EA448FLB	8mm Feint & Margin	Light Blue	£32.87
EA448FLG	8mm Feint & Margin	Light Green	£32.87
EA448FDG	8mm Feint & Margin	Dark Green	£32.87
EA448FOR	8mm Feint & Margin	Orange	£32.87
EA44815RD	15mm Feint	Red	£32.87
EA44810LB	10mm Squares	Light Blue	£32.87
EA448BPK	Blank	Pink	£32.87
EA448BRD	Blank	Red	£32.87
EA448BYW	Blank	Yellow	£32.87

A4 Exercise Books 40 Pages
(210 x 297mm)
Pack of 100

Code	Ruling	Colour	
EA44010DB	10mm Squares	Dark Blue	£32.87

A4 Exercise Books 32 Pages
(210 x 297mm)
Pack of 100

Code	Ruling	Colour	
EA432FRD	8mm Feint & Margin	Red	£30.79
EA432FLB	8mm Feint & Margin	Light Blue	£30.79
EA432FLG	8mm Feint & Margin	Light Green	£30.79
EA432FOR	8mm Feint & Margin	Orange	£30.79
EA432FYW	8mm Feint & Margin	Yellow	£30.79
EA43210FRD	10mm Feint & Margin	Red	£30.79
EA43210RD	10mm Feint	Red	£30.79
EA43215LB*	15mm Feint	Light Blue	£30.79
EA43210OR	10mm Squares	Orange	£30.79
EA432BARD	15mm Feint/Alt. Blank	Red	£30.79
EA432BFLG	Top Blank/ Bottom 8mm Ft	Light Green	£30.79
EA432BFLB	Top Blank/ Bottom 13mm Ft	Light Blue	£30.79
EA432BFPU	Top Blank/ Bottom 13mm Ft	Purple	£30.79
EA432BFYW	Top Blank/ Bottom 15mm Ft	Yellow	£30.79
EA432BRD*	Blank	Red	£30.79
EA432BLB	Blank	Light Blue	£30.79
EA432BLG	Blank	Light Green	£30.79
EA432BYW	Blank	Yellow	£30.79

*While stocks last

A4 Exercise Books 24 Pages
(210 x 297mm)
Pack of 100

Code	Ruling	Colour	
EA442BFLG	Top Blank/ Bottom 15mm Ft	Light Green	£32.87

*A wide range of rulings
& colours available*



*Superior quality
75gsm pages*

*Now available
with your logo
overprinted - see
pages 14-18 for
details ...*

classic

Brighter range
of colours



Competitive
prices

**9 x 7" Exercise Books 96 Pages
(229 x 178mm)
Pack of 50**

Code	Ruling	Colour	
E9796DB	8mm Feint & Margin	Dark Blue	£19.95
E9796YW	8mm Feint & Margin	Yellow	£19.95

**9 x 7" Exercise Books 80 Pages
(229 x 178mm)
Pack of 100**

Code	Ruling	Colour	
E9780FRD	8mm Feint & Margin	Red	£22.96
E9780FPU	8mm Feint & Margin	Purple	£22.96
E9780FYW	8mm Feint & Margin	Yellow	£22.96
E9780FLB	8mm Feint & Margin	Light Blue	£22.96
E9780FDB	8mm Feint & Margin	Dark Blue	£22.96
E9780FLG	8mm Feint & Margin	Light Green	£22.96
E9780FDG	8mm Feint & Margin	Dark Green	£22.96
E9780FOR	8mm Feint & Margin	Orange	£22.96
E9780FPK	8mm Feint & Margin	Pink	£22.96
E9780FBU	8mm Feint & Margin	Buff	£22.96
E9780FGY	8mm Feint & Margin	Grey	£22.96
E97806RD	6mm Feint & Margin	Red	£22.96
E97805RD	5mm Squares	Red	£22.96
E97805LB	5mm Squares	Light Blue	£22.96
E97805OR	5mm Squares	Orange	£22.96
E97807YW	7mm Squares	Yellow	£22.96
E97807OR	7mm Squares	Orange	£22.96
E97807LB	7mm Squares	Light Blue	£22.96
E97807PK	7mm Squares	Pink	£22.96
E978010LB	10mm Squares	Light Blue	£22.96
E978010OR	10mm Squares	Orange	£22.96
E978010PU	10mm Squares	Purple	£22.96
E9780BPK	Blank	Pink	£22.96
E9780BDB	Blank	Dark Blue	£22.96
E9780BYW	Blank	Yellow	£22.96
E9780FAOR	8mm F&M/Alt.Blank	Orange	£22.96
E9780FADG	8mm F&M/Alt.Blank	Dark Green	£22.96



Superior quality
75gsm pages

Now available
with your logo
overprinted - see
pages 14-18 for
details ...

9 x 7" Exercise Books 64 Pages
(229 x 178mm)
Pack of 100

Code	Ruling	Colour	
E9764FLB	8mm Feint & Margin	Light Blue	£29.05
E9764FLG	8mm Feint & Margin	Light Green	£29.05
E9764FOR	8mm Feint & Margin	Orange	£29.05
E9764FPU	8mm Feint & Margin	Purple	£29.05
E9764FYW	8mm Feint & Margin	Yellow	£29.05

9 x 7" Exercise Books 48 Pages
(229 x 178mm)
Pack of 100

Code	Ruling	Colour	
E9748FRD	8mm Feint & Margin	Red	£21.43
E9748FDB	8mm Feint & Margin	Dark Blue	£21.43
E9748FYW	8mm Feint & Margin	Yellow	£21.43
E9748FAOR	12mm Feint/Alt Blank	Orange	£21.43
E9748BPK	Blank	Pink	£21.43
E97485OR*	5mm Squares	Orange	£21.43
E97487RD	7mm Squares	Red	£21.43
E974810RD	10mm Squares	Red	£21.43

*While stocks last

9 x 7" Exercise Books 32 Pages
(229 x 178mm)
Pack of 100

Code	Ruling	Colour	
E9732BFPU	Top Blank/Bottom 15mm Ft	Purple	£21.43
E9732BFRD	Top Blank/Bottom 15mm Ft	Red	£21.43

8 x 6½" Exercise Books 80 Pages
(203 x 165mm)
Pack of 100

Code	Ruling	Colour	
E8680FDB	8mm Feint & Margin	Dark Blue	£32.81
E868010LG	10mm Squares	Light Green	£32.81

8 x 6½" Exercise Books 48 Pages
(203 x 165mm)
Pack of 100

Code	Ruling	Colour	
E8648FRD	8mm Feint & Margin	Red	£17.15
E8648FPU	8mm Feint & Margin	Purple	£17.15
E8648FYW	8mm Feint & Margin	Yellow	£17.15
E8648FLB	8mm Feint & Margin	Light Blue	£17.15
E8648FOR	8mm Feint & Margin	Orange	£17.15
E86488LB*	8mm Feint	Light Blue	£17.15
E864812DB	12mm Feint	Dark Blue	£17.15
E864815RD	15mm Feint	Red	£17.15
E8648BYW	Blank	Yellow	£17.15

*While stocks last



Thick 225gsm
board covers



Brighter range
of colours



FAX US ON 01527 558562



EMAIL SALES@FORWARDPRODUCTS.CO.UK



5 1/4 x 6 1/2" 24 Page Note Books

(130 x 165mm)

Pack of 100

- Small general notebook
- For notes and reminders

Code	Ruling	Colour	Packed	
E5624BL*	8mm Feint	Blue	100	£15.75

*While stocks last



6 x 8" Learn To Write Books 40 pages

(160 x 200mm)

Pack of 100

- Helps to develop handwriting skills and to practice joining letters
- Available in two rulings

Code	Ruling	Colour	Pack	
E68LTWPU	4mm Blue Feint Centre/16mm Red Feint	Vivid Purple	100	£29.95
E68LTWRD	6mm Blue Feint Centre/21mm Red Feint	Vivid Red	100	£29.95



6 1/2 x 4" 48 Page Note Books

(165 x 102mm)

Pack of 100

- Great for spelling
- Vibrant colours

Code	Ruling	Colour	Packed	
E6448FM	7mm Feint/ Vertical Centre Mgn.	Light Blue	100	£17.89
E64487F	7mm Feint	Light Blue	100	£17.89

Bleed proof pages for improved handwriting



8 x 4" 80 Page Note Books

(203 x 101mm)

Pack of 100

- 80 page book
- Great for general notes

Code	Ruling	Colour	Packed	
E8480DB	8mm Feint	Dark Blue	100	£41.77

Other rulings and colours available

8 x 4" 32 Page Note Books

(203 x 101mm)

Pack of 100

- Vocabulary and times table books
- Vibrant colours

Code	Ruling	Colour	Packed	
E8432YW	8mm Feint	Vivid Yellow	100	£16.25
E8432RD	12mm Feint	Vivid Red	100	£16.25
E8432PK	10mm Squares	Vivid Pink	100	£16.25
E8432PU	8mm Ft & Centre Line	Vivid Purple	100	£16.25

A4 Mark Books (210 x 297mm)

Pack of 5

- For attendance and marking
- A4 80 pages
- Space for 42 names

Code	Colour	Packed	
EMBA4	Light Blue	5	£18.26



"Reading Together" Books A5 (210x148mm)

Pack of 20

- This booklet is designed to help record primary pupils reading progress.
- Space is also provided for 'comments', enabling teachers, assistants and parents to communicate.

Code	Colour	Packed	
ERT97RD	Red	20	£9.89
ERT97GR	Green	20	£9.89
ERT97YW	Yellow	20	£9.89



Reading Record Books 8" x 6½" (203 x 165mm)

Pack of 25

- Pages ruled with date, page number and remarks column
- Records 'Books I have read'
- 40 pages

Code	Description	Colour	Packed	
ERR86YW	3 Columns: Date, Book/Page no., Remarks	Yellow	25	£16.15



"Find The Word" Books A5 (210 x 148mm)

Pack of 20

- This booklet lists alphabetically, words often used by 7-11 year olds in their writing.
- Space is also provided for pupils to add words that they use regularly.

Code	Colour	Packed	
EFTWRD	Red	20	£9.89



Book Covering Film

- Transparent, self-adhesive book covering film
- Grid marked backing paper for straight application
- Standard 25m Rolls

Code	Description	Unit	
EBCF250	250mm x 25m	Per Roll	£6.64
EBCF330	330mm x 25m	Per Roll	£8.94
EBCF500	500mm x 25m	Per Roll	£13.39



**A4 SEN/Dyslexia Books 48 Pages
(210 x 297mm)
Packs of 10**

- Assist dyslexic and SEN students with our dedicated new range of exercise books
- Pastel tinted pages reduce visual stress for improved pupil performance

Code	Page Col.	Ruling	Cover Colour	
ESNBL8LB	Blue	8mm F&M	Light Blue	£9.10
ESNCR8LB	Cream	8mm F&M	Light Blue	£9.10
ESNGR8LB	Green	8mm F&M	Light Blue	£9.10
ESNPK8LB	Pink	8mm F&M	Light Blue	£9.10
ESNBL8RD	Blue	8mm F&M	Red	£9.10
ESNCR8RD	Cream	8mm F&M	Red	£9.10
ESNGR8RD	Green	8mm F&M	Red	£9.10
ESNPK8RD	Pink	8mm F&M	Red	£9.10
ESNBL8YW	Blue	8mm F&M	Yellow	£9.10
ESNCR8YW	Cream	8mm F&M	Yellow	£9.10
ESNGR8YW	Green	8mm F&M	Yellow	£9.10
ESNPK8YW	Pink	8mm F&M	Yellow	£9.10
ESNBL12LB	Blue	12mm F&M	Light Blue	£9.10
ESNCR12LB	Cream	12mm F&M	Light Blue	£9.10
ESNGR12LB	Green	12mm F&M	Light Blue	£9.10
ESNPK12LB	Pink	12mm F&M	Light Blue	£9.10
ESNBL12RD	Blue	12mm F&M	Red	£9.10
ESNCR12RD	Cream	12mm F&M	Red	£9.10
ESNGR12RD	Green	12mm F&M	Red	£9.10
ESNPK12RD	Pink	12mm F&M	Red	£9.10
ESNBL12YW	Blue	12mm F&M	Yellow	£9.10
ESNCR12YW	Cream	12mm F&M	Yellow	£9.10
ESNGR12YW	Green	12mm F&M	Yellow	£9.10
ESNPK12YW	Pink	12mm F&M	Yellow	£9.10
ESNBL10LB	Blue	10mm Sq.	Light Blue	£9.10
ESNCR10LB	Cream	10mm Sq.	Light Blue	£9.10
ESNGR10LB	Green	10mm Sq.	Light Blue	£9.10
ESNBL10RD	Blue	10mm Sq.	Red	£9.10
ESNCR10RD	Cream	10mm Sq.	Red	£9.10
ESNGR10RD	Green	10mm Sq.	Red	£9.10
ESNPK10RD	Pink	10mm Sq.	Red	£9.10
ESNBL10YW	Blue	10mm Sq.	Yellow	£9.10
ESNCR10YW	Cream	10mm Sq.	Yellow	£9.10
ESNGR10YW	Green	10mm Sq.	Yellow	£9.10
ESNPK10YW	Pink	10mm Sq.	Yellow	£9.10



A4+ Overprinted Exercise Books 80 Pages
(320 x 240mm)
Pack of 45

Code	Ruling	Colour	Price
E220101	8mm Feint & Margin	Red	£27.45
E220102	8mm Feint & Margin	Purple	£27.45
E220103	8mm Feint & Margin	Yellow	£27.45
E220104	8mm Feint & Margin	Light Blue	£27.45
E220105	8mm Feint & Margin	Light Green	£27.45
E220106	8mm Feint & Margin	Orange	£27.45
E220130	8mm Feint & Margin	Pink	£27.45
E220107	12mm Feint & Margin	Red	£27.45
E220108	12mm Feint & Margin	Purple	£27.45
E220109	12mm Feint & Margin	Yellow	£27.45
E220110	12mm Feint & Margin	Light Blue	£27.45
E220111	12mm Feint & Margin	Light Green	£27.45
E220112	12mm Feint & Margin	Orange	£27.45
E220113	8mm Feint	Red	£27.45
E220114	8mm Feint	Light Blue	£27.45
E220115	15mm Feint	Light Blue	£27.45
E220116	Blank	Red	£27.45
E220117	Blank	Purple	£27.45
E220118	Blank	Yellow	£27.45
E220119	Blank	Light Blue	£27.45
E220120	Blank	Light Green	£27.45
E220121	5mm Squares	Orange	£27.45
E220129	5mm Squares	Light Blue	£27.45
E220122	7mm Squares	Yellow	£27.45
E220123	7mm Squares	Light Blue	£27.45
E220124	10mm Squares	Red	£27.45
E220125	10mm Squares	Purple	£27.45
E220126	10mm Squares	Yellow	£27.45
E220127	10mm Squares	Light Blue	£27.45
E220128	10mm Squares	Light Green	£27.45

A4+ Overprinted Exercise Books 48 Pages
(320 x 240mm)
Pack of 45

Code	Ruling	Colour	Price
E220150	8mm Feint & Margin	Red	£22.25
E220151	8mm Feint & Margin	Purple	£22.25
E220152	8mm Feint & Margin	Yellow	£22.25
E220153	8mm Feint & Margin	Light Blue	£22.25
E220154	8mm Feint & Margin	Light Green	£22.25
E220155	Blank	Red	£22.25
E220156	Blank	Purple	£22.25
E220157	Blank	Yellow	£22.25
E220158	Blank	Light Blue	£22.25
E220159	Blank	Light Green	£22.25
E220168	10mm Squares	Light Blue	£22.25
E220169	10mm Squares	Yellow	£22.25

classic overprinted



Bright white bleed proof internal pages



Brighter range of colours



**A4 Overprinted Exercise Books 80 Pages
(210 x 297mm)
Pack of 50**

Code	Ruling	Colour	Price
E220180	8mm Feint & Margin	Red	£19.45
E220181	8mm Feint & Margin	Purple	£19.45
E220182	8mm Feint & Margin	Yellow	£19.45
E220183	8mm Feint & Margin	Light Blue	£19.45
E220184	8mm Feint & Margin	Dark Blue	£19.45
E220185	8mm Feint & Margin	Light Green	£19.45
E220186	8mm Feint & Margin	Dark Green	£19.45
E220187	8mm Feint & Margin	Orange	£19.45
E220188	8mm Feint & Margin	Pink	£19.45
E220189	8mm Feint & Margin	Grey	£19.45
E220206	8mm Feint & Margin	Buff	£19.45
E220190	6mm Feint & Margin	Red	£19.45
E220191	8mm Feint	Light Blue	£19.45
E220192	5mm Squares	Red	£19.45
E220193	5mm Squares	Light Blue	£19.45
E220194	5mm Squares	Orange	£19.45
E220207	5mm Squares	Yellow	£19.45
E220195	7mm Squares	Yellow	£19.45
E220196	7mm Squares	Light Blue	£19.45
E220197	10mm Squares	Light Blue	£19.45
E220211	10mm Squares	Orange	£19.45
E220212	10mm Squares	Red	£19.45
E220198	Blank	Red	£19.45
E220199	Blank	Yellow	£19.45
E220200	Blank	Dark Blue	£19.45
E220201	Blank	Pink	£19.45
E220202	8mm Feint / Alt Blank	Red	£19.45
E220203	8mm Feint / Alt Blank	Purple	£19.45
E220204	8mm Feint / Alt Blank	Dark Green	£19.45
E220205	12mm Feint / Alt Blank	Red	£19.45

**A4 Overprinted Exercise Books 48 Pages
(210 x 297mm)
Pack of 100**

Code	Ruling	Colour	Price
E220280	8mm Feint & Margin	Red	£32.87
E220281	8mm Feint & Margin	Purple	£32.87
E220282	8mm Feint & Margin	Yellow	£32.87
E220283	8mm Feint & Margin	Light Blue	£32.87
E220284	8mm Feint & Margin	Light Green	£32.87
E220285	8mm Feint & Margin	Dark Green	£32.87
E220286	8mm Feint & Margin	Orange	£32.87
E220288	8mm Feint	Light Blue	£32.87
E220287	Blank	Pink	£32.87
E220290	Blank	Red	£32.87
E220291	Blank	Yellow	£32.87

**A4 Overprinted Exercise Books 40 Pages
(210 x 297mm)
Pack of 100**

Code	Ruling	Colour	Price
E220292	10mm Squares	Dark Blue	£32.87

A4 Overprinted Exercise Books 64 Pages
(210 x 297mm)
Pack of 50

Code	Ruling	Colour	Price
E220293	6mm Feint & Margin	Light Blue	£18.67
E220294	6mm Feint & Margin	Red	£18.67
E220230	8mm Feint & Margin	Red	£18.67
E220231	8mm Feint & Margin	Purple	£18.67
E220232	8mm Feint & Margin	Yellow	£18.67
E220233	8mm Feint & Margin	Light Blue	£18.67
E220234	8mm Feint & Margin	Dark Blue	£18.67
E220235	8mm Feint & Margin	Light Green	£18.67
E220236	8mm Feint & Margin	Orange	£18.67
E220237	8mm Feint & Margin	Pink	£18.67
E220296	8mm Feint & Margin	Buff	£18.67
E220340	12mm Feint & Margin	Red	£18.67
E220341	12mm Feint & Margin	Purple	£18.67
E220342	12mm Feint & Margin	Yellow	£18.67
E220343	12mm Feint & Margin	Light Blue	£18.67
E220242	12mm Feint & Margin	Light Green	£18.67
E220243	12mm Feint & Margin	Orange	£18.67
E220404	15mm Feint & Margin	Red	£18.67
E220403	15mm Feint & Margin	Purple	£18.67
E220402	15mm Feint & Margin	Yellow	£18.67
E220400	15mm Feint & Margin	Light Blue	£18.67
E220401	15mm Feint & Margin	Orange	£18.67
E220244	15mm Feint	Light Blue	£18.67
E220345	5mm Squares	Light Blue	£18.67
E220346	5mm Squares	Orange	£18.67
E220347	7mm Squares	Light Blue	£18.67
E220348	7mm Squares	Yellow	£18.67
E220245	10mm Squares	Yellow	£18.67
E220246	10mm Squares	Light Blue	£18.67
E220247	10mm Squares	Light Green	£18.67
E220248	20mm Squares	Light Blue	£18.67
E220249	Blank	Red	£18.67
E220250	Blank	Yellow	£18.67
E220251	Blank	Light Blue	£18.67
E220252	Blank	Light Green	£18.67
E220253	Blank	Buff	£18.67
E220254	8mm Feint/Alt. Blank	Red	£18.67
E220255	8mm Feint/Alt. Blank	Yellow	£18.67
E220256	8mm Feint/Alt. Blank	Light Blue	£18.67
E220349	8mm Feint/Alt. Blank	Light Green	£18.67
E220257	Top Blank/Bottom 15mm Ft	Light Green	£18.67

A4 Overprinted Exercise Books 24 Pages
(210 x 297mm)
Pack of 100

Code	Ruling	Price
E220350	Top Blank/Bottom 15mm Ft	£32.87





Just send us your logo and we will send you a book design!



A4 Overprinted Exercise Books 32 Pages (210 x 297mm) Pack of 100

Code	Ruling	Colour	Price
E220300	8mm Feint & Margin	Red	£30.79
E220301	8mm Feint & Margin	Light Blue	£30.79
E220302	8mm Feint & Margin	Light Green	£30.79
E220351	8mm Feint & Margin	Orange	£30.79
E220352	8mm Feint & Margin	Yellow	£30.79
E220303	10mm Feint & Margin	Red	£30.79
E220304	10mm Feint	Red	£30.79
E220353	15mm Feint	Light Blue	£30.79
E220354	10mm Squares	Orange	£30.79
E220305	15mm Feint/Alt. Blank	Red	£30.79
E220355	Top Blank / Bottom 8mm Ft	Light Green	£30.79
E220306	Top Blank / Bottom 15mm Ft	Yellow	£30.79
E220307	Top Blank / Bottom 13mm Ft	Light Blue	£30.79
E220356	Top Blank / Bottom 13mm Ft	Purple	£30.79
E220357	Blank	Red	£30.79
E220358	Blank	Light Blue	£30.79
E220359	Blank	Light Green	£30.79
E220360	Blank	Yellow	£30.79

9 x 7" Overprinted Exercise Books 80 Pages (229 x 178mm) Pack of 100

Code	Ruling	Colour	Price
E220320	8mm Feint & Margin	Red	£22.96
E220321	8mm Feint & Margin	Purple	£22.96
E220322	8mm Feint & Margin	Yellow	£22.96
E220323	8mm Feint & Margin	Light Blue	£22.96
E220324	8mm Feint & Margin	Light Green	£22.96
E220325	8mm Feint & Margin	Dark Green	£22.96
E220326	8mm Feint & Margin	Orange	£22.96
E220327	8mm Feint & Margin	Pink	£22.96
E220363	8mm Feint & Margin	Buff	£22.96
E220364	8mm Feint & Margin	Dark Blue	£22.96
E220365	8mm Feint & Margin	Grey	£22.96
E220328	6mm Feint & Margin	Red	£22.96
E220329	8mm Feint	Light Blue	£22.96
E220330	5mm Squares	Light Blue	£22.96
E220331	5mm Squares	Orange	£22.96
E220366	5mm Squares	Red	£22.96
E220332	7mm Squares	Light Blue	£22.96
E220333	7mm Squares	Orange	£22.96
E220367	7mm Squares	Pink	£22.96
E220368	7mm Squares	Yellow	£22.96
E220334	10mm Squares	Light Blue	£22.96
E220335	10mm Squares	Orange	£22.96
E220369	10mm Squares	Purple	£22.96
E220336	Blank	Dark Blue	£22.96
E220337	Blank	Pink	£22.96
E220370	Blank	Yellow	£22.96
E220338	8mm F&M/Alt. Blank	Dark Green	£22.96
E220339	8mm F&M/Alt. Blank	Orange	£22.96

**9 x 7" Overprinted Exercise Books 96 Pages
(210 x 297mm)
Pack of 100**

Code	Ruling	Colour	Price
E220361	8mm Feint & Margin	Dark Blue	£19.95
E220362	8mm Feint & Margin	Yellow	£19.95

**9 x 7" Overprinted Exercise Books 64 Pages
(229 x 178mm)
Pack of 100**

Code	Ruling	Colour	Price
E220371	8mm Feint & Margin	Light Blue	£29.05
E220372	8mm Feint & Margin	Light Green	£29.05
E220373	8mm Feint & Margin	Orange	£29.05
E220374	8mm Feint & Margin	Purple	£29.05
E220375	8mm Feint & Margin	Red	£29.05
E220376	8mm Feint & Margin	Yellow	£29.05

**9 x 7" Overprinted Exercise Books 48 Pages
(229 x 178mm)
Pack of 100**

Code	Ruling	Colour	Price
E220390	8mm Feint & Margin	Dark Blue	£21.43
E220391	8mm Feint & Margin	Dark Green	£21.43
E220392	8mm Feint & Margin	Light Blue	£21.43
E220393	8mm Feint & Margin	Red	£21.43
E220394	8mm Feint & Margin	Yellow	£21.43
E220395	12mm Feint/Alt Blank	Orange	£21.43
E220396	Blank	Pink	£21.43
E220397	5mm Squares	Orange	£21.43
E220398	7mm Squares	Red	£21.43
E220399	10mm Squares	Red	£21.43



**A4 Oxford Handwriting Books 48 Pages
(210 x 297mm)
Pack of 50**

Promote handwriting skills with this quality Oxford handwriting book range. Rounded corners and thick glossy covers combine for a professional look and feel that encourages pupils to take pride in their handwriting.

- Contains high quality, smooth 90gsm Optik paper to write on both sides of the page
- 6mm Blue Feint Centre/21mm Red Feint books perfect for younger years
- 4mm Blue Feint Centre/21mm Red Feint books to suit developing pupils
- 48 pages

Code	Ruling	Colour	Pack	Price
EA448HWBL	6mm Blue Feint Centre/21mm Red Feint	Blue	50	£28.95
EA448HWRD	4mm Blue Feint Centre/16mm Red Feint	Red	50	£28.95





Upgrade your students work with these stunning books



Thicker quality pages ensure zero ink bleed'

**A4+ Oxford Exercise Books 80 Pages
(320 x 240mm)
Pack of 45**

Code	Ruling	Colour	Price
OXO80FLB	8mm Feint & Margin	Light Blue	£34.10
OXO80FLG	8mm Feint & Margin	Light Green	£34.10
OXO80FPU	8mm Feint & Margin	Purple	£34.10
OXO80FRD	8mm Feint & Margin	Red	£34.10
OXO80FYW	8mm Feint & Margin	Yellow	£34.10
OXO80FOR	8mm Feint & Margin	Orange	£34.10
OXO80FPK	8mm Feint & Margin	Pink	£34.10
OXO8012YW	12mm Feint & Margin	Yellow	£34.10
OXO80BRD	Blank	Red	£34.10
OXO805LB	5mm Squares & Margin	Light Blue	£34.10
OXO805OR	5mm Squares & Margin	Orange	£34.10
OXO807LB	7mm Squares & Margin	Light Blue	£34.10
OXO807YW	7mm Squares & Margin	Yellow	£34.10
OXO8010LB	10mm Squares & Margin	Light Blue	£34.10
OXO8010YW	10mm Squares & Margin	Yellow	£34.10

**A4+ Oxford Exercise Books 48 Pages
(320 x 240mm)
Pack of 45**

Code	Ruling	Colour	Price
OXO48FYW	8mm Feint & Margin	Yellow	£31.40
OXO48FRD	8mm Feint & Margin	Red	£31.40

**A4 Oxford Exercise Books 80 Pages
(210 x 297mm)
Pack of 50**

Code	Ruling	Colour	Price
OXA480FDB	8mm Feint & Margin	Dark Blue	£25.30
OXA480FDG	8mm Feint & Margin	Dark Green	£25.30
OXA480FGY	8mm Feint & Margin	Grey	£25.30
OXA480FLB	8mm Feint & Margin	Light Blue	£25.30
OXA480FLG	8mm Feint & Margin	Light Green	£25.30
OXA480FOR	8mm Feint & Margin	Orange	£25.30
OXA480FPK	8mm Feint & Margin	Pink	£25.30
OXA480FPU	8mm Feint & Margin	Purple	£25.30
OXA480FRD	8mm Feint & Margin	Red	£25.30
OXA480FYW	8mm Feint & Margin	Yellow	£25.30
OXA48012RD	12mm Feint & Margin	Red	£25.30
OXA48012YW	12mm Feint & Margin	Yellow	£25.30
OXA48012LG	12mm Feint & Margin	Light Green	£25.30
OXA48012PU	12mm Feint & Margin	Purple	£25.30
OXA480BRD	Blank	Red	£25.30
OXA4805LB	5mm Squares & Margin	Light Blue	£25.30
OXA4805OR	5mm Squares & Margin	Orange	£25.30
OXA4805RD	5mm Squares & Margin	Red	£25.30
OXA4807LB	7mm Squares & Margin	Light Blue	£25.30
OXA4807YW	7mm Squares & Margin	Yellow	£25.30
OXA48010LB	10mm Squares & Margin	Light Blue	£25.30
OXA48010YW	10mm Squares & Margin	Yellow	£25.30
OXA48010OR	10mm Squares & Margin	Orange	£25.30
OXA48010RD	10mm Squares & Margin	Red	£25.30
OXA48010LG	10mm Squares & Margin	Light Green	£25.30
OXA480FARD	8mm Feint/Alt. Blank	Red	£25.30
OXA480FAYW	8mm Feint /Alt Blank	Yellow	£25.30
OXA480HWRD	Handwriting Lines 6,4,6mm	Bright Red	£42.89
OXA480HWBL	Handwriting Lines 7,6,7mm	Bright Blue	£42.89

A4 Oxford Exercise Books 64 Pages
(210 x 297mm)
Pack of 50

Code	Ruling	Colour	Price
OXA464FLB	8mm Feint & Margin	Light Blue	£24.80
OXA464FOR	8mm Feint & Margin	Orange	£24.80
OXA464FPK	8mm Feint & Margin	Pink	£24.80
OXA464FRD	8mm Feint & Margin	Red	£24.80
OXA464FPU	8mm Feint & Margin	Purple	£24.80
OXA464FDB	8mm Feint & Margin	Dark Blue	£24.80
OXA464FLG	8mm Feint & Margin	Light Green	£24.80
OXA464FYW	8mm Feint & Margin	Yellow	£24.80
OXA46415LB	15mm Feint	Light Blue	£24.80

A4 Oxford Exercise Books 48 Pages
(210 x 297mm)
Pack of 100

Code	Ruling	Colour	Price
OXA448FLG	8mm Feint & Margin	Light Green	£37.75
OXA448FRD	8mm Feint & Margin	Red	£37.75
OXA448FYW	8mm Feint & Margin	Yellow	£37.75
OXA44810FRD	10mm Feint & Margin	Red	£37.75

9 x 7" Oxford Exercise Books 80 Pages
(229 x 178mm)
Pack of 100

Code	Ruling	Colour	Price
OX9780FPU	8mm Feint & Margin	Purple	£34.80
OX9780FYW	8mm Feint & Margin	Yellow	£34.80
OX9780FRD	8mm Feint & Margin	Red	£34.80
OX9780FLB	8mm Feint & Margin	Light Blue	£34.80
OX9780FLG	8mm Feint & Margin	Light Green	£34.80
OX9780FPK	8mm Feint & Margin	Pink	£34.80
OX9780FDB	8mm Feint and Margin	Dark Blue	£34.80
OX97805LB	5mm Squares & Margin	Light Blue	£34.80
OX97805OR	5mm Squares & Margin	Orange	£34.80
OX978010OR	10mm Squares & Margin	Orange	£34.80
OX9780FADG	8mm Feint/Alt. Blank	Dark Green	£34.80

9x7" Oxford Exercise Books 48 Pages
(229 x 178mm)
Pack of 100

Code	Ruling	Colour	Price
OX9748MDB	Music Staves/Alt. 8mm Feint	Dark Blue	£25.63



Premium durable glossy covers with matt writing panels



Just send us your logo and we will send you a book design!





oxford
overprinted



A4+ Oxford Overprinted Exercise Books 80 Pages (320 x 240mm) Pack of 45

Code	Ruling	Colour	Price
OXPO80FLB	8mm Feint & Margin	Light Blue	£34.10
OXPO80FLG	8mm Feint & Margin	Light Green	£34.10
OXPO80FPU	8mm Feint & Margin	Purple	£34.10
OXPO80FRD	8mm Feint & Margin	Red	£34.10
OXPO80FYW	8mm Feint & Margin	Yellow	£34.10
OXPO80FOR	8mm Feint & Margin	Orange	£34.10
OXPO80FPK	8mm Feint & Margin	Pink	£34.10
OXPO8012YW	12mm Feint & Margin	Yellow	£34.10
OXPO80BRD	Blank	Red	£34.10
OXPO805LB	5mm Squares & Margin	Light Blue	£34.10
OXPO805OR	5mm Squares & Margin	Orange	£34.10
OXPO807YW	7mm Squares & Margin	Yellow	£34.10
OXPO807LB	7mm Squares & Margin	Light Blue	£34.10
OXPO8010LB	10mm Squares & Margin	Light Blue	£34.10
OXPO8010YW	10mm Squares & Margin	Yellow	£34.10

A4+ Oxford Overprinted Exercise Books 48 Pages (320 x 240mm) Pack of 45

Code	Ruling	Colour	Price
OXPO48FYW	8mm Feint & Margin	Yellow	£31.40
OXPO48FRD	8mm Feint & Margin	Red	£31.40

A4 Oxford Overprinted Exercise Books 80 Pages (210 x 297mm) Pack of 50

Code	Ruling	Colour	Price
OXPA480FDB	8mm Feint & Margin	Dark Blue	£25.30
OXPA480FDG	8mm Feint & Margin	Dark Green	£25.30
OXPA480FGY	8mm Feint & Margin	Grey	£25.30
OXPA480FLB	8mm Feint & Margin	Light Blue	£25.30
OXPA480FLG	8mm Feint & Margin	Light Green	£25.30
OXPA480FOR	8mm Feint & Margin	Orange	£25.30
OXPA480FPK	8mm Feint & Margin	Pink	£25.30
OXPA480FPU	8mm Feint & Margin	Purple	£25.30
OXPA480FRD	8mm Feint & Margin	Red	£25.30
OXPA480FYW	8mm Feint & Margin	Yellow	£25.30
OXPA48012RD	12mm Feint & Margin	Red	£25.30
OXPA48012YW	12mm Feint & Margin	Yellow	£25.30
OXPA48012LG	12mm Feint & Margin	Light Green	£25.30
OXPA48012PU	12mm Feint & Margin	Purple	£25.30
OXPA480BRD	Blank	Red	£25.30
OXPA4805LB	5mm Squares & Margin	Light Blue	£25.30
OXPA4805OR	5mm Squares & Margin	Orange	£25.30
OXPA4805RD	5mm Squares & Margin	Red	£25.30
OXPA4807LB	7mm Squares & Margin	Light Blue	£25.30
OXPA4807YW	7mm Squares & Margin	Yellow	£25.30
OXPA48010LB	10mm Squares & Margin	Light Blue	£25.30
OXPA48010YW	10mm Squares & Margin	Yellow	£25.30
OXPA48010OR	10mm Squares & Margin	Orange	£25.30
OXPA48010RD	10mm Squares & Margin	Red	£25.30
OXPA48010LG	10mm Squares & Margin	Light Green	£24.80
OXPA480FARD	8mm Feint / Alt. Blank	Red	£25.30
OXPA480FAYW	8mm Feint/Alt. Blank	Yellow	£25.30
OXPA480HWRD	Handwriting Lines 6,4,6mm	Bright Red	£42.89
OXPA480HWBL	Handwriting Lines 7,6,7mm	Bright Blue	£42.89

A4 Oxford Overprinted Exercise Books 64 Pages
(210 x 297mm)
Pack of 50

Code	Ruling	Colour	Price
OXPA464FLB	8mm Feint & Margin	Light Blue	£24.80
OXPA464FOR	8mm Feint & Margin	Orange	£24.80
OXPA464FPK	8mm Feint & Margin	Pink	£24.80
OXPA464FRD	8mm Feint & Margin	Red	£24.80
OXPA464FPU	8mm Feint & Margin	Purple	£24.80
OXPA464FDB	8mm Feint & Margin	Dark Blue	£24.80
OXPA464FLG	8mm Feint & Margin	Light Green	£24.80
OXPA464FYW	8mm Feint & Margin	Yellow	£24.80
OXPA46415LB	15mm Feint	Light Blue	£24.80

A4 Oxford Overprinted Exercise Books 48 Pages
(210 x 297mm)
Pack of 100

Code	Ruling	Colour	Price
OXPA448FLG	8mm Feint & Margin	Light Green	£37.75
OXPA448FRD	8mm Feint & Margin	Red	£37.75
OXPA448FYW	8mm Feint & Margin	Yellow	£37.75
OXPA44810FRD	10mm Feint & Margin	Red	£37.75

9 x 7" Oxford Overprinted Exercise Books 80 Pages
(229 x 178mm)
Pack of 100

Code	Ruling	Colour	Price
OXP9780FPU	8mm Feint & Margin	Purple	£34.80
OXP9780FYW	8mm Feint & Margin	Yellow	£34.80
OXP9780FRD	8mm Feint & Margin	Red	£34.80
OXP9780FLB	8mm Feint & Margin	Light Blue	£34.80
OXP9780FLG	8mm Feint & Margin	Light Green	£34.80
OXP9780FPK	8mm Feint & Margin	Pink	£34.80
OXP970FDB	8mm Feint & Margin	Dark Blue	£34.80
OXP97805LB	5mm Squares & Margin	Light Blue	£34.80
OXP97805OR	5mm Squares & Margin	Orange	£34.80
OXP978010OR	10mm Squares & Margin	Orange	£34.80
OXP9780FADG	8mm Feint / Alt. Blank	Dark Green	£34.80

9 x 7" Oxford Overprinted Exercise Books 48 Pages
(229 x 178mm)
Pack of 100

Code	Ruling	Colour	Price
OXP9748MDB	Music Staves/Alt. 8mm Feint	Dark Blue	£25.63



mychoice Bespoke Exercise Books

Ask for a Free Sample Pack

Your logo here. **FREE!**



Guaranteed Summer Delivery!*

* On orders placed before 1st June

New cover option upgrade for **FREE!**



Reliable Quality.
Reliable Delivery...
Everytime!

mychoice Exercise Book Options

Personalise your inside covers

- Gold ● Blue ● Yellow ● Green ●
- Cream ● Pink ● Grey ● Red ●
- Purple ● Lime Green ● Orange ●

11 fantastic colour options or pick full colour covers for maximum impact

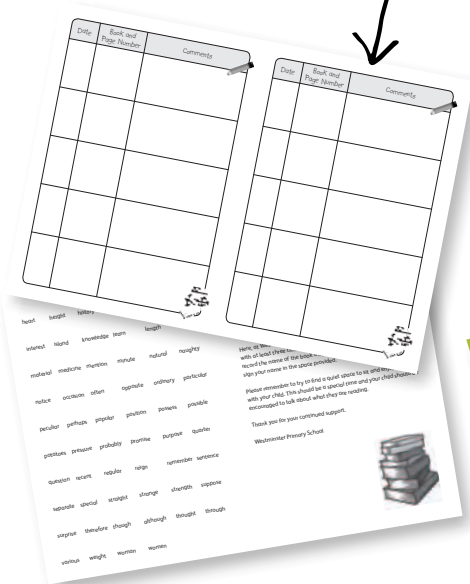

Why not laminate covers for durability

Tinted pages. Ideal for dyslexic pupils!

NEW COVER Option - upgrade for FREE



Choice of 5 tints

- Blue ● Yellow ● Green ●
- Cream ● Pink ●

Reliable Quality. Reliable Delivery...Everytime!

Ask for a Free Sample Pack

Colours shown are for illustrative purposes only

A



A Book Covering Films

- Transparent, self-adhesive book covering film
- Grid marked backing paper for straight application

Standard 25m Rolls

Code	Description	Unit	
EBCF250	250mm x 25m	Per Roll	£6.64
EBCF330	330mm x 25m	Per Roll	£8.94
EBCF500	500mm x 25m	Per Roll	£13.39

B



B Exercise Book Jackets

- Easy to fit
- Protects your students' exercise books throughout the academic year

Code	Size	Unit	
EBJ97CL	9 x 7"	pk 50	£5.75
EBJA4CL	A4	pk 25	£7.95

C Heavy Duty Exercise Book Jackets

- Manufactured from tough 140-micron clear PVC
- Glass clear to give your students' books a pristine finish
- Available in all popular sizes

Code	Description	Unit	
EGCBJ97	9 x 7"	pk 100	£37.35
EGCBA4	A4	pk 100	£46.70
EGCBJOS	A4+	pk 100	£52.64



A A4 Starter Sketch Book

- Excellent general purpose book at a very economical price
- 40 pages of 100gsm quality acid free drawing cartridge
- 280 micron thick black covers

EA4SSB pk 100 £59.95



A

B Laminated Sketch Books

- Manufactured with a 380 micron laminated cover for extra durability.
- 40 pages of 140gsm quality acid free drawing cartridge paper
- Standard colour black
- Other colours available when ordering large quantities (Blue, Burgundy and Green)

ELSBA4 A4 pk 40 £34.99



B

C Traditional Spiral Sketch Books

- High quality sketchbooks suitable for all mediums
- 30 sheets of 100gsm acid free drawing cartridge paper
- 280 micron black cover

ETSBA4	A4	each	£2.79
ETSBA3	A3	each	£4.29



C

D Soft Cover Spiral Bound Sketch Books

- Smart sketch book with durable black laminated covers
- 50 pages of 140gsm acid free drawing cartridge paper
- Give your pupils a sense of pride in their sketches

ESBKA4 A4 each £3.29



D

E Premium Hard Backed Sketch Books

- Superior quality hand made sketch books
- 380-micron Linen effect black covers
- 96 sheets of 140gsm all media cartridge paper

EPSBA4	A4	each	£4.89
EPSBA3	A3	each	£11.78



E



Cover colour options



Fantail Orange



Kingfisher Blue



Plover Purple



Woodpecker Green

A Premium Quality Project Books

- ✓ Are you doing justice to your students' project work? These handmade project books are just the job!
- ✓ Oversize A4 (312 x 223mm) so that you can glue a full A4 sheet in with ease.
- ✓ Top quality 100gsm black sugar paper leaves.
- ✓ 4 Vivid colour cover options to choose from.

Code	Colour	Pages	Packed	
EPBWG	Woodpecker Green	40	30	£39.86
EPBKB	Kingfisher Blue	40	30	£39.86
EPBFO	Fantail Orange	40	30	£39.86
EPBPP	Plover Purple	40	30	£39.86



B Value 32 Page Scrapbooks

- Oversize A4 and A3 scrapbooks (315 x 230mm or 440 x 315mm)
- Select from black or assorted coloured sugar paper pages
- Plain 225gsm coloured card covers (colours will vary)

EVSA4BK	A4+ Black Pages	pk 25	£12.99
EVSA4CP	A4+ Coloured Pages	pk 25	£12.99
EVSA3BK	A3+ Black Pages	pk 25	£37.75
EVSA3CP	A3+ Coloured Pages	pk 25	£37.75



C Premium Casebound Notebooks

- Rhino branded manuscript books
- Casebound covers with a durable thread sewn spine
- Excellent quality, feint ruled paper
- 192 pages

SCDBA4	A4	pk 5	£10.89
SCDBA5	A5	pk 5	£6.58



D Hardback Notebooks

- Fully casebound
- Hard-wearing linen effect cover for heavy usage
- Quality sewn binding gives added durability
- 96 pages

EHBNA4	A4	pk 5	£9.95
EHBNA5	A5	pk 10	£12.29

High quality 90gsm Optik paper means you can use every sheet of your notebook and write on both sides of the page without worrying that the ink will show through!

A Oxford Campus Project Book A4+

- Four repositionable dividers that allow you to separate your notes quickly and easily by project or subject
- Pages are micro-perforated for easy tearing, ensuring a clean edge
- 8mm ruled with margin
- 200 pages
- Assorted colour pack

ECAMPB	A4+	pk 3	£13.75
--------	-----	------	--------

B Oxford Campus Notebook A4+

- Strong twin-wire binding allows the notebook to fold back on itself or lay flat on the desk.
- Pages are micro-perforated for easy tearing, ensuring a clean edge
- 8mm ruled with margin
- 140 pages
- Assorted colour pack contains five different colours from red, aqua, navy, purple, pink, green and black

ECAMNB	A4+	pk 5	£16.29
--------	-----	------	--------



C Spiral Notebooks

- Constructed over a rigid back board with micro-perforation for easy removal of sheets
- A4 pad is punched 4 holes for filing
- Each pad contains 80 sheets of 75gsm paper with faint ruling & margin

EA4SPNB	A4	pk 12	£14.95
EA5SPNB	A5	pk 12	£11.35



D Pukka Pad Stripes Polypropylene Wirebound Jotta Notebook

- Striped, wirebound jotta notebook in three different sizes
- Perfect for home, study or office use
- 200 pages

JPSA4	A4	pk3	£8.19
JPSA5	A5	pk3	£5.47
JPSA6	A6	pk3	£3.99



E Pukka Dyslexia Pad A4 80gsm Ruled With Margin

Pukka Pads coloured notepads have been designed with guidance from the Irlen Institute who specialise in products for those with visual perception difficulties. With the use of formulated coloured paper and tinted ruling with margin, the coloured pads can help those with Irlen syndrome and /or Dyslexia. Located within the inside front cover of the pad is a visual stress self-testing form. This will help anyone with Irlen syndrome to assess which colour pad they are most suited to.

- 100 pages

SENPADGD	Gold	pk 6	£10.99
SENPADGN	Green	pk 6	£10.99
SENPADLV	Lavender	pk 6	£10.99
SENPADRS	Rose	pk 6	£10.99
SENPADTQ	Turquoise	pk 6	£10.99



FAX US ON 01527 558562



EMAIL SALES@FORWARDPRODUCTS.CO.UK

Bleed proof paper for superior opacity



A4 Punched Exercise Paper - Best Seller!

Code	Ruling	Packed		1-9 Reams	10+ Reams
EP8FM2H	8mm Feint & Margin	Ream	2 Hole Punched	£3.64	£3.43

Prices shown are per ream

A4 Exercise Papers

Code	Ruling	Packed		
EP8FMUP	8mm Feint & Margin	Ream	Unpunched	£4.55
EP8FM4H	8mm Feint & Margin	Ream	4 Hole Punched	£4.55
EP8F2H	8mm Feint	Ream	2 Hole Punched	£4.55
EP8FUP	8mm Feint	Ream	Unpunched	£4.55
EP6FM2H	6mm Feint & Margin	Ream	2 Hole Punched	£4.55
EP15F2H	15mm Feint	Ream	2 Hole Punched	£4.55
EPP2H	Plain	Ream	2 Hole Punched	£4.55

A4 Graph Papers

Code	Ruling	Packed		
EP15102H	1, 5, 10mm	Ream	2 Hole Punched	£5.57
EP1510UP	1, 5, 10mm	Ream	Unpunched	£6.15
EP210202H	2, 10, 20mm	Ream	2 Hole Punched	£6.15

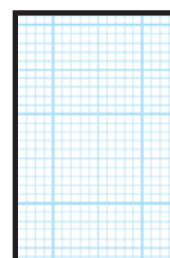

1/5/10mm Graph

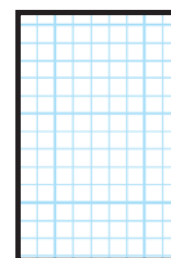

2/10/20mm Graph

A4 Squared Papers

Code	Ruling	Packed		
EP5S2P	5mm Squares	Ream	2 Hole Punched	£4.78
EP5SUP	5mm Squares	Ream	Unpunched	£4.78
EP7S2P	7mm Squares	Ream	2 Hole Punched	£4.78
EP7SUP	7mm Squares	Ream	Unpunched	£4.78
EP10S2P	10mm Squares	Ream	2 Hole Punched	£4.78
EP10SUP	10mm Squares	Ream	Unpunched	£4.78



Dot Lattice Triangle

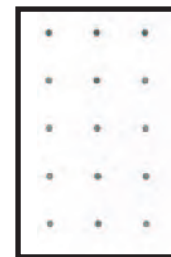

Dot Lattice Squares

A4 Maths Papers

Code	Ruling	Packed		
EPDLT	Dot Lattice Triangles	100	Unpunched	£2.73
EPDLS	Dot Lattice Squares	100	Unpunched	£2.73

02

COPY PAPERS

WHITE COPIER PAPER	31-34
CONQUEROR PAPER	33
NCR PAPER	33
WHITE COPIER CARD	34
LASER PAPER & CARD	34
INKJET PAPER	34
KASKAD COLOURED PAPER & CARD	35-36
CERTIFICATE PAPER & CARD	37



A



A Standard White Office Paper

- Guaranteed for reliable performance
- Sources may vary
- Excellent for everyday use

PWBOXA4		ream	POA
---------	--	------	-----



B Golden Star Professional Paper

- Bright white copier paper at a very competitive price point
- Dense sheet formation for high opacity
- Easy-open paper wrappers
- Suitable for mono and colour printing

PGPROA4	A4	ream	POA
PGPROA3	A3	ream	POA

C



C Mycopy Professional Paper

- A high white PEFC certified sheet with good bulk and handling characteristics
- 101 micron thick for reliable high speed printing
- Produced from sustainable farmed eucalyptus pulp
- Our most popular brand!
- Endorsed by 100's of schools
- Brilliant White shade
- Mill plants more trees than it harvests

PMPROA4	A4	ream	POA
PMPROA3	A3	ream	POA



A Inacopia Office Professional White Paper A4

- A superb balance between quality and economy
- A reliable, crisp white sheet that runs superbly but doesn't cost the earth
- Top quality bright white paper
- Suitable for colour & double sided copying

PINPROA4		ream	POA
----------	--	------	-----



A

B Mycopy Executive 80gsm Paper

- Brilliant white 80gsm paper
- All the benefits of MyCopy™ Professional with added bulk and thickness providing even better results
- Bright white & good rigidity for quality results
- Produced from sustainable farmed Eucalyptus pulp

PMYEXA4	A4	ream	POA
PMYEXA3	A3	ream	POA

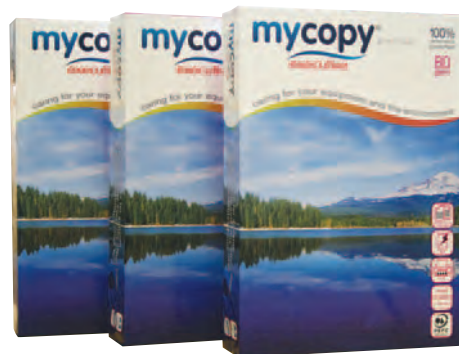

B

C Inacopia Office White Paper 80gsm

- Crisp white sheet with excellent rigidity and bulk for excellent results every time
- Equally at home with colour or mono output for better quality results
- High bulk for very reliable performance
- Bright white & smooth for a superb finish

			1-9	10+
PINEXA4	A4	ream	£2.99	POA
PINEXA3	A3	ream	£6.98	POA



C

D Xerox Premier A5 Paper

- High white 80gsm copier paper
- Guaranteed for use in digital copiers, laser printers, and inkjet printers
- Accredited with Nordic Swan and E1 flower

ASIMEX	A5	ream	£2.94
--------	----	------	-------



D

A



A Conqueror Smooth/Satin A4 Paper

Market leading premium quality paper for prestigious publications. Manufactured from a mix of cotton & virgin FSC fibres, creating an environmentally sound product.

- A crisp, contemporary feel with the polished & sharp ultra smooth CX22 finish, or rich & warm wove finish
- Watermarked & guaranteed for use on inkjet & laser printers

		GSM	Pack	
CQ20248	Ultra Smth CX22 Diamond White	100	500	£31.27
CQ20249	Ultra Smth CX22 Cream	100	500	£31.27
CQ20253	Wove Brilliant White	100	500	£31.27
CQ20252	Wove Cream	100	500	£31.27
CQ25486	Wove High White	100	500	£31.27
CQ25666	Wove Vellum	100	500	£31.27

B



B Conqueror Texture A4 Paper

Market leading premium quality paper for prestigious publications. Manufactured from a mix of cotton & virgin FSC fibres, creating an environmentally sound product.

- For a natural tactile and totally distinctive touch to your communications, use the classic & versatile Laid finish, or subtle embossed Contour finish
- Watermarked & guaranteed for use on inkjet & laser printers

		GSM	Pack	
CQ20260	Laid Brilliant White	100	500	£31.27
CQ25504	Laid High White	100	500	£31.27
CQ25574	Laid Cream	100	500	£31.27
CQ20261	Laid Vellum	100	500	£31.27
CQ20734	Contour Brilliant White	100	500	£31.27

C



C Carbonless (NCR) Paper

- Multi-part sets at your fingertips
- Produce quality NCR sets, when you need them, using your own equipment
- Use pre-collated sets for fast and ready to use forms
- Specially formulated adhesive for glued sets

		Pack	
IDCBWM	A4 Top Copy - White	500	£15.01
IDCFBYW	A4 Middle Copy Yellow	500	£19.88
IDCFBL	A4 Bottom Copy Blue	500	£15.36
IDCFGR	A4 Bottom Copy Green	500	£13.71
ID2PW	A4 2 pt Pre-Collated Sets P/W	250 sets	£14.38
ID3R	A4 3 pt Reverse Collated	167 sets	£15.63

Digital

DIG2	A4 2 pt Pre-Collated Sets W/Y	1250 sets	£81.12
DIG3F	A4 3 pt Fwd Collated W/Y/P	835 sets	£66.59



A White Copier Card 160gsm

- Produce your own document covers using your laser printer or copier
- Other uses include job cards or notices

			1-9	10+
MCW4160	A4 MyCopy Pk 250		£5.09	£4.63
MCW3160	A3 Rey Pk 250		£10.41	£9.35

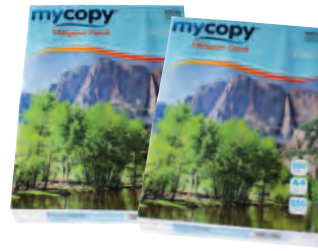

A

B Inacopia Elite Copier 100gsm

- Top quality, ultra-white paper that gives brilliant results in both mono and colour printing
- The whitest paper in the world - 172 CIE whiteness
- Ideal for presentations, reports, newsletters, statements and mailings



			1-9	10+
PIN100A4	A4	pk 250	£3.48	£2.95
PIN100A3	A3	ream	£12.75	£11.60



C Xerox Smooth Colotech + Laser Paper & Card

- Ultra white and extra smooth
- Perfect for producing high quality reports/brochures etc.

			Packs per box	Price Per Pack
CLC4100X	A4 100 gsm	pk 500	4	£9.64
CLC3100X	A3 100 gsm	pk 500	4	£21.33
CLC4120X	A4 120 gsm	pk 500	4	£11.23
CLC4160X	A4 160 gsm	pk 250	5	£8.44
CLC3160X	A3 160 gsm	pk 250	5	£16.86
CLC4200X	A4 200 gsm	pk 250	4	£15.75
CLC4250X	A4 250 gsm	pk 250	4	£16.71



C

D Gloss Coated Colour Laser Paper

- Ideal for producing your own glossy literature
- Double sided - same stunning quality both sides

			Packs per box	Price Per Pack
XCLG4120	A4 120 gsm	pk 500	6	£16.97
XCLG3120	A3 120 gsm	pk 500	3	£32.02
XCLG4140	A4 140 gsm	pk 400	6	£18.30



D

E Photo Quality Inkjet Paper 105g

- Superb for high quality colour printing
- Matt finish, medium weight
- Premium look

14402EP	A4	pk 100	£18.13
---------	----	--------	--------



E

F Uncoated Inkjet Paper Rolls

- High whiteness for excellent contrast
- Good formation for even prints

		Width	Length	Rolls Per Carton	Carton Price
X97762	90gsm	914mm	50m	4	£66.60
X97763	90gsm	841mm	50m	4	£68.82
X97764	90gsm	610mm	50m	4	£45.69



F

Kaskad Copier Paper & Card

RANGE GUIDE

Colour	A4 80 gsm	A4 120 gsm	A4 160 gsm	A3 80 gsm	A3 160 gsm
Pastel Colours					
Bunting Yellow	KK608055	KK619055	KK621055	KK608655	KK621655
Eider Vellum	KK608012	-	KK621012	KK608612	KK621612
Pintail Cream	KK608054	-	KK621054	KK608654	-
Leafbird Green	KK608065	KK619065	KK621065	KK608665	KK621665
Siskin Green	KK608061	-	KK621061	KK608661	-
Merlin Blue	KK608072	-	KK621072	KK608672	-
Puffin Blue	KK608075	KK619075	KK621075	KK608675	KK621675
Skylark Violet	KK608085	KK619085	KK621085	KK608685	KK621685
Flamingo Pink	KK608025	KK619025	KK621025	KK608625	KK621625
Salmon	KK608031	-	KK621031	KK608631	-
Curlew Cream	KK608013	KK619013	KK621013	KK608613	KK621613
Sparrow Grey	KK608093	-	KK621093	-	-
Wheatear Yellow	KK608053	-	KK621053	KK608653	-

Bright Colours

Oriole Gold	KK608056	-	KK621056	KK608656	-
Canary Yellow	KK608057	KK619057	KK621057	KK608657	KK621657
Barbet Green	KK608069	-	KK621069	KK608669	-
Warbler Green	KK608064	-	KK621064	KK608664	-
Peacock Blue	KK608077	-	KK621077	KK608677	KK621677
Swallow Blue	KK608088	-	KK621088	-	-
Plover Purple	KK608086	-	KK621086	KK608686	-
Hummingbird Amethyst	KK608087	-	KK621087	KK608687	-
Bullfinch Pink	KK608022	-	KK621022	KK608622	-
Lapwing Brown	KK608016	-	KK621016	-	-
Owl Grey	KK608094	-	KK621094	-	-

Deep Colours

Rosella Red	KK608029	-	KK621029	-	-
Robin Red	KK608028	-	KK621028	KK608628	KK621628
Fantail Orange	KK608048	-	KK621048	KK608648	KK621648
Mandarin Orange	KK608059	-	KK621059	-	-
Goldcrest Yellow	KK608058	KK619058	KK621058	-	KK621658
Parakeet Green	KK608067	-	KK621067	KK608667	-
Woodpecker Green	KK608068	-	KK621068	KK608668	-
Mallard Green	KK608063	-	KK621063	KK608663	KK621663
Kingfisher Blue	KK608078	-	KK621078	KK608678	-
Nuthatch Brown	KK608019	-	KK621019	-	-
Raven Black†	KK608099	-	-	-	-

Brilliant Neon Tints

Cerise	KK608030	-	-	-	-
Lime Green	KK608060	-	-	-	-
Orange	KK608040	-	-	-	-
Yellow	KK608050	-	-	-	-

- The Kaskad range of coloured paper is probably the widest range of coloured paper in Europe
- Kaskad's superb selection of tasteful shades from pastel tints through to vibrant fluorescent colours are guaranteed to meet all your copying, laser printing, inkjet printing and fax paper requirements
- Most of the shades are available in a variety of weights and sizes.
- Kaskad's colourful range ensures maximum flexibility whatever the requirement

These colours are a printed guide only, to see the real thing call us for a free sample swatch.

* While stocks last
† Black not suitable for use in copiers or lasers

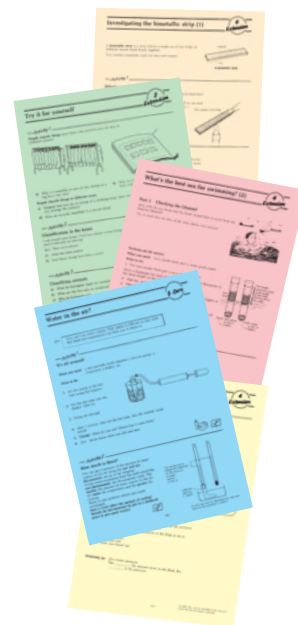

Did you know?

That using a colour like Eider Vellum can help children with reading difficulties such as Dyslexia "letters no longer jump around like they do on white paper"
Please speak to your SEN coordinator about running a trial



Kaskad Copier Paper & Card

- Guaranteed for laser printing, double-sided copying and mono inkjet printing
- Use for newsletters, reports, internal memos etc
- Environmentally friendly, Totally chlorine free (TCF)
- Plain paper fax? Use a colour to distinguish incoming faxes
- Would you like to see the colours? Phone now for a sample swatch

Description	Qty per pack	Pks per box	1-4	5+
A4 80gsm				
Pastel Tints (PT)	500	5	£5.20	£4.39
Bright Tints (BT)	500	5	£5.99	£4.99
Deep Tints (DT)	500	5	£6.29	£5.29
Brilliant Neon (BR)	500	5	£9.75	£8.59
Black (BK)	500	5	£12.70	£11.67

A3 80gsm				
Pastel Tints (PT)	500	5	£10.09	n/a
Bright Tints (BT)	500	5	£10.79	n/a
Deep Tints (DT)	500	5	£11.65	n/a

A4 120gsm				
Pastel Tints (PT)	250	5	£6.15	n/a
Bright Tints (BT)	250	5	£7.05	n/a
Deep Tints (DT)	250	5	£7.65	n/a

A4 160gsm Card				
Pastel Tints (PT)	250	5	£6.09	£5.55
Bright Tints (BT)	250	5	£6.99	£5.85
Deep Tints (DT)	250	5	£7.29	£6.19
Nuthatch Brown KK621019	250	5	£12.35	£11.56

A3 160gsm Card				
Pastel Tints (PT)	250	5	£14.95	n/a
Bright Tints (BT)	250	5	£15.99	n/a
Deep Tints (DT)	250	5	£16.99	n/a

Assorted Packs					
KAS480PA	A4 80gsm	Pastel	1 x 500	£8.07	n/a
KAS480BA	A4 80gsm	Bright	1 x 500	£8.29	n/a
KAS480DA	A4 80gsm	Deep	1 x 500	£8.81	n/a
KAS160PA	A4 160gsm	Pastel	1 x 250	£8.47	n/a
KAS160BA	A4 160gsm	Bright	1 x 250	£9.08	n/a
KAS160DA	A4 160gsm	Deep	1 x 250	£9.53	n/a

Assorted Packs

The 160gsm assorted packs have 50 sheets of each colour and the 80gsm contain 100 sheets of each colour. The following colours are in each pack:

Pastel: Flamingo Pink, Bunting Yellow, Leafbird Green, Puffin Blue, Skylark Violet

Bright Tints: Bullfinch Pink, Oriole Gold, Barbet Green, Peacock Blue, Plover Purple

Deep Tints: Rosella Red, Fantail Orange, Goldcrest Yellow, Woodpecker Green, Kingfisher Blue.



ask for a free swatch



FOR BLACK CARD
SEE PAGE 184

The prices on this page may vary during the life of this catalogue due to market fluctuations

Create Stunning Sparkly Certificates



A Georama Metallic Paper & Card

- Stunning range of metallic card and paper
- Ideal for prestigious certificates and awards
- Guaranteed for copying and laser - subject to machine specifications

Standard Weight 120g Paper		Pack	
A4MGGO	A4 Metallic Gold	100	£19.97
A4GMSI	A4 Metallic Silver	100	£19.97
A4GMBR	A4 Metallic Bronze	100	£19.97
A4GMLI	A4 Metallic Lilac	100	£19.97
A4GMAM	A4 Metallic Aurora Mauve	100	£19.97
A4GMAS	A4 Metallic Arctic Sky	100	£19.97
A4GMDB	A4 Metallic Deep Sea Blue	100	£19.97
A4GMRU	A4 Metallic Ruby	100	£19.97
A4GMASTD	A4 Metallic Assorted (Gold, Silver & Bronze)	100	£19.97

Heavyweight 285g Card		Pack	
A4GM285GO	A4 Metallic Gold	100	£32.89
A4GM285SI	A4 Metallic Silver	100	£32.89
A4GM285BR	A4 Metallic Bronze	100	£32.89

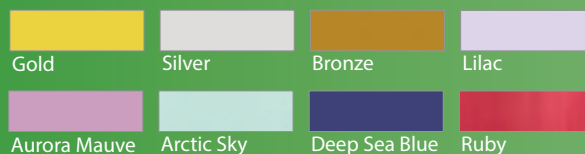

Georama Metallics do not come with a border printed on them, unlike the pictures shown.

B



B Certificate Border Sheets

- Fully guaranteed for use on copiers, laser and inkjet printers
- Ideal for house or individual awards
- 90gsm quality natural parchment paper

		Pack	
BSGO	A4 Gold	100	£14.47
BSSI	A4 Silver	100	£14.47
BSBR	A4 Bronze	100	£14.47

C

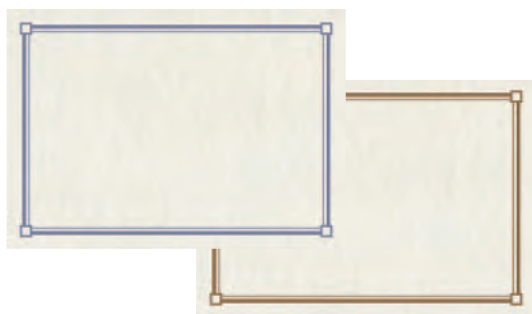

C Superior Foiled Sheets

- Stunning - ideal for prestigious awards
- 150gsm heavyweight natural parchment
- Fully guaranteed for use on copiers, laser and inkjet printers

		Pack	
FBSGO	A4 Gold Foil	100	£37.74
FBSSI	A4 Silver Foil	100	£37.74



03

PRINT & PERSONALISATION

MYCHOICE EXERCISE BOOKS	39
PRINTED STATIONERY	40
PROSPECTUS FOLDERS	40
GIFTS & PROMOTIONAL ITEMS	41
LOGO MATS	42
WATER BOTTLES	43





Exercise Book Options

- Gold ●
- Blue ●
- Yellow ●
- Green ●
- Cream ●
- Pink ●
- Grey ●
- Red ●
- Purple ●
- Lime Green ●
- Orange ●

Personalise your inside covers

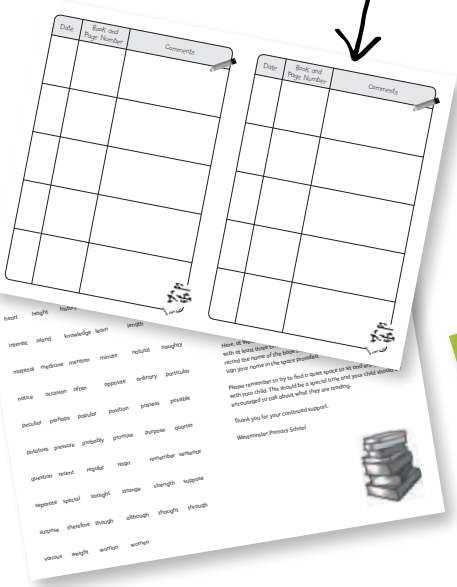

11 fantastic colour options or pick full colour covers for maximum impact



Why not laminate covers for durability



Tinted pages. Ideal for dyslexic pupils!



NEW COVER Option - upgrade for FREE



Choice of 5 tints

- Blue ●
- Yellow ●
- Green ●
- Cream ●
- Pink ●

Reliable Quality. Reliable Delivery...Everytime!

Ask for a Free Sample Pack

Colours shown are for illustrative purposes only



PRINTED STATIONERY AND PROSPECTUS FOLDERS...

GIVE YOUR SCHOOL A PROFESSIONAL IMAGE!

Forward Products can assist with your litho and digital printing requirements, providing a high quality finish at a competitive price.

We can produce the following items:



Email sales@forwardproducts.co.uk for competitive prices

CALL US ON 01527 878348 VISIT WWW.FORWARDPRODUCTS.CO.UK

PROMOTIONAL PRODUCTS & GIFTS

Perfect for Open Days, School Leavers etc.



Need some inspiration?
Call **01527 878348**



Customisable with your school's logo

- Durable rubber backed mats
- High quality type 6.6 nylon pile
- 5 year guarantee
- Delivered in just 2 weeks
- Logos must be sent electronically
- Choose from 30 colours
- Same price irrespective of number of colours used
- No setup or artwork charges
- Supplied portrait or landscape
- Choice of gripper backing for carpets or flat backing for hard floors
- Delivery 2 weeks from receipt of approved artwork
- Carriage paid



Code	Size cm	Approx. feet	Price
LOGO23	60 x 85	2 x 3	£69.20
LOGO253	75 x 85	2.5 x 3	£77.73
LOGO34	85 x 115	3 x 4	£105.48
LOGO35	85 x 150	3 x 5	£129.97
LOGO310	85 x 300	3 x 10	£233.62
LOGO46	115 x 180	4 x 6	£194.43
LOGO47	115 x 200	4 x 7	£213.20

Code	Size cm	Approx. feet	Price
LOGO48	115 x 240	4 x 8	£250.75
LOGO410	115 x 300	4 x 10	£313.21
LOGO57	150 x 200	5 x 7	£270.33
LOGO58	150 x 240	5 x 8	£367.48
LOGO510	150 x 300	5 x 10	£408.46
LOGO6565	200 x 200	6.5 x 6.5	£362.51
LOGO6510	200 x 300	6.5 x 10	£540.94



CALL US ON 01527 878348



VISIT WWW.FORWARDPRODUCTS.CO.UK

Water-Bottles

...for those on the go!

PROVIDE YOUR STUDENTS WITH DRINKING WATER THROUGHOUT THE DAY TO INCREASE HYDRATION, CONCENTRATION AND IMPROVE BEHAVIOUR.

Translucent bottles available in a selection of Blue, Red, Yellow and Green H²O graphics.

OR
Customised bottles available with your own logo or bespoke design. Call for details.



Features include...

- Tough & durable
- Low cost
- Replaceable sports cap
- 'Non-spill' design
- Easy-fill wide neck
- Dishwasher safe
- 500ml capacity
- Customisable



Look good - feel good!

Standard Translucent Water Bottles

Choice of 4 print colours
Supplied with replaceable sports caps
Order water bottles in multiples of 50 per colour

CBXAE**	Water Bottles	each	£1.30
CBX50C	Replacement Caps	pk 50	£12.98

** Please specify colour when placing your order

Custom Printed Water Bottles

Bespoke print with your choice of design!
Minimum order 50 bottles
Order water bottles in multiples of 50 only

CBX12	POA
-------	-----



04

STATIONERY

LAMINATING SUPPLIES	45-46
ENVELOPES & POSTROOM	47-49
LABELS & STICKERS	50-52
DIARIES & PLANNERS	53-54
REFILL PADS & NOTEBOOKS	55-57
DUPLICATE, VISITOR & MESSAGE BOOKS	57-58
SKETCHBOOKS	59
FLIPCHART PADS	60
ID BADGES & LANYARDS	61
CLIPBOARDS & CONFERENCE FOLDERS	62
STAMPS & INK PADS	63-65
BINDING CONSUMABLES	66
STICKY NOTES & INDEX MARKERS	67-70
WRITING & COLOURING	71-90
HIGHLIGHTERS	91
WHITEBOARDS, MARKERS & ACCESSORIES	92-108
MATHS EQUIPMENT AND PENCIL CASES	109-111
ZIP WALLETS	112
FILING	113-126
STORAGE	127-136
DESK ACCESSORIES	137-142
ESSENTIALS	143-146
ADHESIVES	147-151
SCISSORS	152
STAPLERS, TACKERS & HOLE PUNCHES	153-158
BATTERIES	159
CASH BOXES & KEY SAFES	160
DOOR STOPS	160
CLOCKS & STOP WATCHES	161



A



A ID Badge Size Gloss Laminating Pouches

- Ideal for name badges, business cards & small signs
- Gives professional looking results

65 x 95mm

LP6799	250 mic	pk 100	£3.30
--------	---------	--------	-------

54 x 86mm

LP5486	250 mic	pk 100	£3.39
--------	---------	--------	-------

B



B Matt Laminating Pouches

- Eliminate glare from glossy surfaces - no more reflections
- Suitable for pencil and ball pen usage

LPMA4150	A4	150 mic	pk100	£10.65
LPMA3150	A3	150 mic	pk100	£21.99
LPMA4200	A4	200 mic	pk 100	£16.15
LPMA3200	A3	200 mic	pk 100	£27.15

C



C GBC Ultima 35 Roll Film

- For GBC Eziload machines
- Gives clear glossy finish to documents
- Pack of 2 rolls

22780	305mm x 75 mic x 75m	pk 2	£70.72
-------	----------------------	------	--------

D



D Laminating Film Rolls

- High quality low melt film for top quality results
- Gloss finish
- 25mm core size

LAMR2751	320mm x 75mic x 100m	pk 2	£43.74
LAMR3751	455mm x 75mic x 100m	pk 2	£70.75
LAMR31251	455mm x 125mic x 50m	pk 2	£58.52
LAMR4751	635mm x 75mic x 100m	pk 2	£71.85
LAMR41251	635mm x 125mic x 50m	pk 2	£80.94



A A5 Gloss Laminating Pouches

LA5150	150 mic	pk 100	£4.57
LA5200	200 mic	pk 100	£6.92
LA5250	250 mic	pk 100	£8.33

B A4 Gloss Laminating Pouches

			1-9	10+
LA4150	150 mic	pk 100	£7.82	£6.32
LA4200	200 mic	pk 100	£9.44	£8.44
LA4250	250 mic	pk 100	£10.49	£9.49

C A3 Gloss Laminating Pouches

			1-9	10+
LA3150	150 mic	pk 100	£15.09	£13.99
LA3200	200 mic	pk 100	£18.52	£17.35
LA3250	250 mic	pk 100	£20.98	£19.79



- Generous size pouches for strong long-life finish
- Easier to insert paper due to anti-static design
- Rounded corners for extra safety
- High gloss for a glass-clear finish



D Pre-Punched Laminating Pouches A4 Gloss

- 150 micron gloss laminating pouches
- Pre-punched for quick filing
- High quality, low melt

PLA4150	pk 100	£13.39
---------	--------	--------

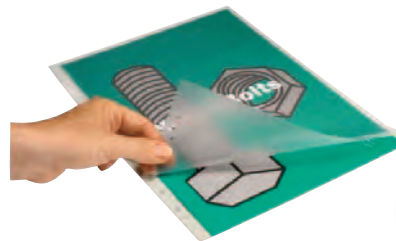

D

FOR LAMINATORS
SEE PAGE 163-164

E Card Pouch Carriers

- Prevent pouch jamming when you use our card carriers
- Prolong the life of your laminator by preventing glue seepage
- Available in A3 and A4 sizes

CPCA4	A4	pk 10	£3.23
CPCA3	A3	pk 10	£4.38



E

F Teflon Pouch Carriers

- The Lifejacket™ is designed to eliminate the risk of jamming or wrapping around the rollers which can be a problem when laminating smaller items in an oversized pouch.
- Made of Teflon® which allows heat to completely penetrate through the pouch giving excellent lamination results every time and will work on most laminators.
- Very long lasting and eliminates the need to continually buy standard card carriers

LPTCA4	A4	each	£9.70
LPTCA3	A3	each	£18.69



F

Board Backed Envelopes

Manilla paper front with heavy duty board back with strong peel and seal flap. "Please do not bend" printed on face in red. Excellent for school reports, certificates, photos and other items that need the ultimate in protection.

Code	Size	mm (inches)	Plain/Window	Colour	Style	Seal Type	Weight	Box Qty	Price
13935	C4	324 x 229 (12¾x9)	Plain	Manilla		Peel & Seal	115g	125	£21.24



Board Backed





IDEAL FOR
MAGAZINES,
BROCHURES AND
PROSPECTUSES

Gusset

Gusseted Envelopes

A range of heavyweight envelopes with expansion facility. The 25mm gusset gives scope for sending bulky items such as text books while still giving maximum protection.

Code	Size	mm (inches)	Plain/Window	Colour	Style	Seal Type	Weight	Box Qty	Price
1991	C4	324 x 229 (12¾x9)	Plain	Manilla		Peel & Seal	120g	100	£20.14
11101	15x10	15" x 10" x 1"	Plain	Manilla		Peel & Seal	140g	100	£30.42



Manilla Wage Envelopes

- Strong wage envelopes, suitable for holding coins
- Available with or without pre-printed wage details
- 108 x 102mm
- 90gsm self seal

3420	Unprinted	108 x 102mm	pk 1000	£25.76
3430	Pre-printed	108 x 102mm	pk 1000	£30.40



CD Envelopes

- Protective envelopes for the safe storage of all CDs
- Available in paper or polypropylene
- Paper has an adhesive flap
- Polypropylene is available punched so it can be stored in a ring binder

F02206	Paper		pk 50	£9.37
F02207	Polypropylene		pk 50	£15.90

Standard White Envelopes

Competitively priced range of white self seal envelopes with an attractive blue opaque inner, and the added advantage of coming from sustainable forest sources.



Sustainable Source

Code	Size	mm (inches)	Plain/Window	Wallet/Pocket	Style	Seal Type	Weight	Box Qty	Price
2602	C6	114 x 162 (4½x6¾)	Plain	Wallet		Self Seal	90g	1000	£18.70
12882	DL	110 x 220 (4¼x8⅝)	Plain	Wallet		Self Seal	80g	1000	£11.95
12884	DL	110 x 220 (4¼x8⅝)	Window	Wallet		Self Seal	80g	1000	£13.74
13893	C5	229 x 162 (9 x 6½)	Plain	Pocket		Self Seal	90g	500	£10.99
13084	C5	229 x 162 (9 x 6½)	Window	Pocket		Self Seal	90g	500	£10.99
12891	C4	324 x 229 (12¾ x 9)	Plain	Pocket		Self Seal	90g	250	£9.99
12892	C4	324 x 229 (12¾ x 9)	Window	Pocket		Self Seal	90g	250	£9.99

Manilla Envelopes



Code	Size	mm (inches)	Plain/Window	Wallet/Pocket	Style	Seal Type	Weight	Box Qty	Price
3.5 X 6" Envelopes									
13770	3½x6	89 x 152 (3½x6)	Plain	Wallet		Gummed	80g	1000	£11.24
DL Envelopes									
23780	DL	220 x 110 (8⅝x4¼)	Plain	Pocket		Gummed	80g	500	£10.83
13780	DL	110 x 220 (4¼x8⅝)	Plain	Wallet		Gummed	80g	1000	£16.49
C5 Envelopes									
13848	C5	229 x 162 (9x6¾)	Plain	Pocket		Gummed	80g	500	£10.60
13885	C5	229 x 162 (9x6¾)	Plain	Pocket		Self Seal	80g	500	£8.58
C4 Envelopes									
1380	C4	324 x 229 (12¾x9)	Plain	Pocket		Gummed	80g	250	£9.17
1385	C4	324 x 229 (12¾x9)	Plain	Pocket		Self Seal	80g	250	£8.99
13888	C4	324 x 229 (12¾x9)	Plain	Pocket		Self Seal	115g	250	£14.77
15 x 10" & 16 x 12" Envelopes									
13890	15x10	381 x 254 (15x10)	Plain	Pocket		Self Seal	115g	250	£18.78
13896	16x12	406 x 305 (16x12)	Plain	Pocket		Self Seal	115g	250	£28.58
C3 Envelopes									
13872	C3	457 x 324 (18x12¾)	Plain	Pocket		Self Seal	115g	125	£21.13

Dinner Money Envelopes

- Strong manilla envelopes
- Bulk box of 2000
- 98 x 67mm (3¾ x 2⅔)
- 80 gsm plain pocket
- Gummed flaps

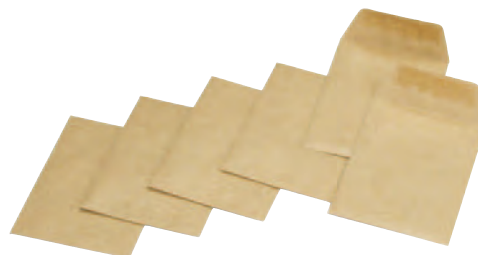

ALL ITEMS ON THIS PAGE CAN BE PERSONALISED, PLEASE CALL FOR PRICES

24011 pk 2000 £31.23



CALL US ON 01527 878348



VISIT WWW.FORWARDPRODUCTS.CO.UK

A



A Cotton String/Twine

- Ideal for postroom or general office use
- Also suitable for art & craft

TCG500	Thick Cotton String	500g	£5.07
CTW250	Cotton String/Twine No. 5	250g	£3.57
CTW500	Cotton String/Twine No. 3	500g	£5.07

B



B Letter Opener

- For opening letters and parcels
- Steel blade with easy grip wooden handle

F03985	Letter Opener	each	£8.97
--------	---------------	------	-------

C



C Electronic Postal Scales

- Modern and stylish 1kg postal scale
- Weighs up to 1kg in 1g increments
- Uses 9v battery (not supplied)

F00956	Scales	each	£46.43
--------	--------	------	--------

D



D Raffle Tickets

- Numbered cloakroom/raffle tickets
- With security numbering
- 5 tickets to view
- 100% recycled paper
- Assorted colours

43320	1-500	pk 12	£13.68
43330	1-1000	pk 6	£13.68



High Quality Copier & Laser Labels

- Bright white labels give clear printed copies every time
- Each set is polybagged to ensure that the product stays in mint condition
- We recommend the label sheet is passed through the printer only once
- Avery reference shown in brackets for simple cross referencing

Laser Labels (Rounded Corners) A4 Sheets

Label size	Labels/ sheet	Sheets/ pack	Avery Code	1-4	5+
A65 38 x 21 mm	65	100	(L7651)	£8.89	£7.99
A24 64 x 34 mm	24	100	(L7159)	£8.89	£7.99
A21 63 x 38 mm	21	100	(L7160)	£8.89	£7.99
A18 63 x 46 mm	18	100	(L7161)	£8.89	£7.99
A16 99 x 34 mm	16	100	(L7162)	£8.89	£7.99
A14 99 x 38 mm	14	100	(L7163)	£8.89	£7.99
A12 63 x 72 mm	12	100	(L7164)	£8.89	£7.99
A8 99 x 67 mm	8	100	(L7165)	£8.89	£7.99
A6 99 x 93 mm	6	100	(L7166)	£8.89	£7.99
A4 99 x 127 mm	4	100	(L7169)	£8.89	£7.99
A2 200 x 144 mm	2	100	(L7168)	£8.89	£7.99
A1 200 x 288 mm	1	100	(L7167)	£8.89	£7.99



Copier Labels (Squared Corners) A4 Sheets

Label size	Labels/ sheet	Sheets/ pack	1-4	5+
P16S 105 x 35 mm	16	100	£8.89	£7.99
P16E 105 x 37 mm	16	100	£8.89	£7.99
P8S 105 x 70 mm	8	100	£8.89	£7.99
P4E 105 x 148 mm	4	100	£8.89	£7.99
P2E 210 x 148 mm	2	100	£8.89	£7.99
P1E 210 x 297 mm	1	100	£8.89	£7.99



Laser Labels (Rounded Cornered)

A6
(L7166)

99 X 93

6 label/sheet

A8
(L7165)

99 X 68

8 label/sheet

A12
(L7164)

63 X 72

12 label/sheet

A14
(L7163)

99 X 38

14 label/sheet

A16
(L7162)

99 X 34

16 label/sheet

A18
(L7161)

63 X 46

18 label/sheet

A21
(L7160)

63 X 38

21 label/sheet

A24
(L7159)

64 X 34

24 label/sheet

A65
(L7651)

38 X 21

65 label/sheet

A4
(L7169)

99 X 139

4 label/sheet

A2
(L7168)

200 X 144

2 label/sheet

A1
(L7167)

200 X 183

1 label/sheet

Copier Labels (Square Cornered)

P1E

210 X 297

1 label/sheet

P2E

210 X 148

2 label/sheet

P4E

105 X 148.5

4 label/sheet

P8S

105 X 70

8 label/sheet

P16E

105 X 37

16 label/sheet

P16S

105 X 35

16 label/sheet

A



A Reward Stickers Jumbo Bus Box

- This fun, bus shaped box provides a sturdy storage container
- Contains 800 stickers on 4 rolls which are dispensed through a slot

RSB800	Jumbo Bus	pk 800	£12.67
--------	-----------	--------	--------

B



B Reward Sticker Pads

- Fantastic reward stickers in hundreds of assorted designs and sizes all in a handy pad to keep everything organised
- Pad size 145 x 240mm
- 738 Stickers/pad (unless stated)

RSPSF	Schooltime Fun		£5.20
RSPSSS	Super Stars & Smiles		£5.20

C



C Metallic Self Adhesive Star Stickers

- 14 mm across the width
- A cost effective way to motivate

F02535	Gold	pk 700	£1.17
F02595	Silver	pk 700	£1.17
F02615	Assorted	pk 700	£1.17

D



D Labels in Dispensers

Coloured Circles

F01141	Blue 19mm dia.	pk 1280	£2.88
F01161	Green 19mm dia.	pk 1280	£2.88
F01181	Orange 19mm dia.	pk 1280	£2.88
F01201	Red 19mm dia.	pk 1280	£2.88
F01221	Yellow 19mm dia.	pk 1280	£2.88

E



E Coloured Labels

- Vibrant colours
- Ideal for colour coding files

25 x 50mm

F01951	Green Rectangles	pk 320	£4.06
F01991	Red Rectangles	pk 320	£4.06
F02011Y	Yellow Rectangles	pk 320	£4.06



A Address Labels On-A-Roll

- Supplied in convenient dispenser style box with perforations between each label
- Adhere instantly without moisture or mess
- Strong, plain labels suitable for addressing envelopes, marking files and many other uses
- Labels are 89 x 36mm
- 250 labels on a roll



A

LABADD each £1.55



B Avery Laser Labels

- Avery addressing labels are now easier to peel and faster to apply with the unique QuickPEEL feature
- Divide the label sheet along the perforation to expose label edges and easily lift label from the sheet or simply keep the sheet intact and peel the labels as usual
- Guaranteed Jam Free with outstanding print quality
- Fully compatible with popular laser and colour laser printers



B

Order Code	Size mm	(Avery Code)	Labels per sheet	Sheets per pack	
L7159AV	64 x 34	L7159-100	24	100	£27.64
7160AV	63.5 x 38.1	L7160-40	21	40	£14.58
L7160AV	63.5 x 38.1	L7160-100	21	100	£27.64
F00842AV	63.5 x 38.1	L7160-500	21	500	£104.93
L7161AV	63.5 x 46.6	L7161-100	18	100	£27.64
L7162AV	99.1 x 34	L7162-100	16	100	£27.64
7163AV	99.1 x 38.1	L7163-40	14	40	£14.58
L7163AV	99.1 x 38.1	L7163-100	14	100	£27.64
L7173AV	99.1 x 57	L7173-100	10	100	£27.64
7165AV	99.1 x 67.7	L7165-40	8	40	£14.58
L7165AV	99.1 x 67.7	L7165-100	8	100	£27.64
L7169AV	139 x 99.1	L7169-100	4	100	£27.64
L7168AV	199.6 x 143.5	L7168-100	2	100	£27.64

C Avery Filing Labels

- Find things faster with clear and professionally labelled files
- Available in 2 sizes

Order Code	Size mm	(Avery Code)		Labels per sheet	Sheets per pack	
L7171AV	200 x 60	L7171-25	Lever Arch	4	25	£17.48
L7172AV	100 x 30	L7172-25	Ring Binder	18	25	£17.71



C

A

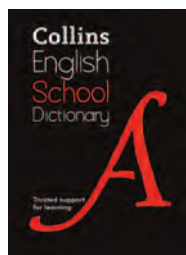

A Collins School Dictionaries

- Top quality dictionaries and thesauruses from the UK's favourite publisher
- Specifically designed for pupils, perfect for school work and homework
- Three top-selling titles for education are below - please call if the edition you require is not listed as we can supply the full Collins range

DPBSD	School Dictionary	each	£6.67
DPGEM	Gem Dictionary	each	£4.17
TPGEM	Gem Dictionary & Thesaurus	each	£4.17

B



B "Reading Together" Books A5

- This booklet is designed to help record primary pupils reading progress.
- Space is also provided for 'comments', enabling teachers, assistants and parents to communicate
- A5 210 x 148mm

	Colour	Packed	
ERT97RD	Red	20	£9.89
ERT97GR	Green	20	£9.89
ERT97YW	Yellow	20	£9.89

C



C Secondary Teachers' Planners

- High quality teachers' planners
- Designed for secondary school teachers

General information includes:

- Important Dates
- Aug – July Calendar (undated)
- Staff Meetings
- Inset Training Days
- Departmental Meetings

Academic Organiser Includes:

- Teaching Timetables
- Homework timetable
- Index of resources/teaching aids
- Books/Equipment on loan
- Termly Planner
- Attendance Register
- Homework Register
- Pastoral Register

* FREE personalisation of the front covers for orders over 25. Please call for more information.

Code	Size	Contents	Unit	Price
DSTPA55	A5	5 Period	each	£7.20
DSTPA45	A4	5 Period	each	£8.83
DSTPA46	A4	6 Period	each	£8.83

D



D Primary Teacher Planner

- High quality teachers' planners
- Information includes:**
- Important dates
 - August - July calendar (undated)
 - Timetable and planning sections
 - Summary sheets
 - Pupil record and mark register

Code	Size	Unit	Price
DPTPA5	A5	each	£8.66
DPTPA4	A4	each	£9.65





Best Selling Academic Year 2021-22 Diaries

CHOOSE FROM 12 COLOURS

- Quality hard-back diaries with gold blocked covers
- Available in 12 colours in a large range of sizes and formats
- Handy ribbon bookmark
- All diaries feature hourly appointment times: WTV - hourly 8am - 5pm; PPD - hourly 8am - 5pm with 3 lines per hour

	A5 Diaries		A4 Diaries	
	12 Month WTV*	12 Month PPD*	12 Month WTV*	12 Month PPD*
Light Grey	DA5WVG	DA5DPG	DA4WVG	DA4DPG
Teal	DA5WVTE	DA5DPTE	DA4WVTE	DA4DPTE
Black	DA5WVBK	DA5DPBK	DA4WVBK	DA4DPBK
Blue	DA5WVBL	DA5DPBL	DA4WVBL	DA4DPBL
Red	DA5WVRD	DA5DPRD	DA4WVRD	DA4DPRD
Green	DA5WVGR	DA5DPGR	DA4WVGR	DA4DPGR
Burgundy	DA5WVBU	DA5DPBU	DA4WVBU	DA4DPBU
Mauve	DA5WVMA	DA5DPMA	DA4WVMA	DA4DPMA
Yellow	DA5WVYW	DA5DPYW	DA4WVYW	DA4DPYW
Dark Pink	DA5WVDP	DA5DPDP	DA4WVDP	DA4DPDP
Lime Green	DA5WVLG	DA5DPLG	DA4WVLG	DA4DPLG
Orange	DA5WVOR	DA5DPOR	DA4WVOR	DA4DPOR
Price	£2.30	£3.50	£4.30	£5.40

*WTV = Week To View *PPD = Page Per Day

Colours shown are not an exact representation of the actual colour, and provide an indication only



Gold Foil Service

We can gold foil your school logo to the cover. Please call for a free quotation!

Academic Wall Planner

- Unmounted planners for academic year
- Supplied complete with pen and sticker kit
- 909 x 610mm

DLWP12 each £3.20

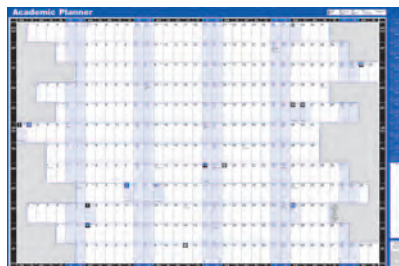

CALL US ON 01527 878348



VISIT WWW.FORWARDPRODUCTS.CO.UK

A



A Spiral Notebooks

- A4 pad is punched 4 holes for filing
- Each pad contains 80 sheets of 75gsm paper with faint ruling & margin

EA4SPNB	A4	pk 12	£14.95
EA5SPNB	A5	pk 12	£11.35

B



B Transparent Covered Spiral Notebooks

- Brightly coloured polypropylene notebooks contain 80 sheets per pad
- Transparent covers
- Available in A4 with square corners and A5 with round corners
- Quality 70gsm pages
- Lined 8mm with grey lines and pink margin

10036	A4 Green	pk 5	£21.86
10037	A4 Blue	pk 5	£21.86
10038	A4 Red	pk 5	£21.86
10033	A5 Green	pk 5	£14.44
10034	A5 Blue	pk 5	£14.44
10035	A5 Red	pk 5	£14.44

C



C Oxford Black n' Red Casebound Books

- Fully cased sturdy hardback black covers with a red spine, provide life-long protection of notes
- Featuring sewn pages for tamper-resistant durability, ideal for permanent records and archiving
- Premium 90gsm smooth paper allows both sides of the page to be used, with minimal show-through of notes
- Red ribbon for page marking and referencing important notes
- Includes a date planner (to record important meetings, term dates, holidays and special occasions), colour maps and travel information
- Contents page for quick referencing
- 192 ruled pages

66174	A4	pk 5	£42.27
66857	A5	pk 5	£30.18

D



D Oxford Black n' Red Wirebound Books

- Hardback laminated glossy black covers and a red wire binding for a smart appearance
- Strong twin-wire binding allows pages to fold back or lay flat
- Premium 90gsm smooth paper allows both sides of the page to be used, with minimal show-through of notes
- Includes contents page for quick referencing, time zone map and metric conversion tables
- Pages are micro-perforated for easy removal with a neat edge
- 140 ruled pages

79019	A4	pk 5	£43.74
L67000	A5	pk 5	£30.44



A Hback Notebooks

- Fully casebound, with hard-wearing linen effect cover for heavy usage
- Quality sewn binding for durability
- Printed on high quality white ruled paper
- 96 pages

EHBNA4	A4	pk 5	£9.95
EHBNA5	A5	pk 10	£12.29

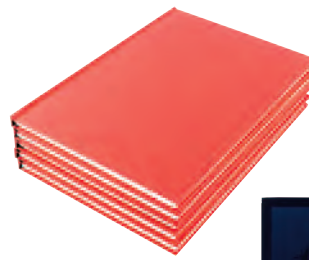

A

B Premium Casebound Notebooks

- Rhino branded manuscript books
- Casebound covers with a durable threadsewn spine
- Excellent quality, faint ruled paper
- 192 pages

SCDBA4	A4	pk 5	£10.89
SCDBA5	A5	pk 5	£6.58



B

C Oxford Campus Project Book A4+

- 4 repositionable dividers allow you to separate your notes quickly and easily
- Pages are micro-perforated for easy tearing, ensuring a clean edge
- 200 pages, 8mm ruled with margin
- Assorted colours

ECAMPB	A4+	pk 5	£13.75
--------	-----	------	--------



C

D Oxford Campus Notebook A4+

- Strong twin-wire binding allows the notebook to fold back on itself or lay flat
- Pages are micro-perforated for easy tearing, ensuring a clean edge
- 140 pages, 8mm ruled with margin
- 5 assorted colours

ECAMNB	A4	pk 5	£16.29
--------	----	------	--------



D

E Pukka Dyslexia Pad A4 80gsm Ruled With Margin

- Coloured notepads, designed with guidance from the Irlen Institute who specialise in visual perception difficulties
- 100 pages ruled with margin
- Includes a visual stress self-testing form to help assess which colour pad is most appropriate

SENPADGD	Gold	pk 6	£10.99
SENPADGN	Green	pk 6	£10.99
SENPADLV	Lavender	pk 6	£10.99
SENPADRS	Rose	pk 6	£10.99
SENPADTQ	Turquoise	pk 6	£10.99

NEW!



E

F Oxford Campus Refill Pads A4

- Contains high quality, smooth 90gsm Optik paper to write on both sides
- Four hole punched for quick and easy filing into ring binders or lever arch files
- 140 pages, 8mm ruled with margin
- Timetable included so you never miss a lecture or seminar!
- Assorted packs contain random colours

SCR140*	pk 5	£3.78
---------	------	-------

*While stocks last



REDUCED
50%
OFF
TO CLEAR

F

A



A Q Connect Refill Pads

- A4 pads, punched 2 hole and head bound
- Ruled with feint lines
- Suitable for any 2 hole ring binders
- Cover protects your notes from dust and dirt
- Contain 80 sheets (160 pages) of 60gsm paper

F02228	Feint & Margin	pk 10	£10.15
F02227	Feint	pk 10	£10.29

B



B Shorthand Notebooks

- Spiral binding allow pages to be folded flat
- Rigid board back adds strength
- Cover to protect notes from dust and dirt
- Feint ruled on both sides
- Quality paper ensures ink will not feather
- 203 x 127mm (8 x 5")

31003	80 Leaf (160 Pages)	pk 10	£5.34
31002	150 Leaf (300 Pages)	pk 10	£8.90

C



C A4 Memo Pads

- Board backed for rigidity
- Accepts ink without bleeding or feathering
- 8mm feint ruled lines
- White pads contains 80 sheets

32001	White	pk 10	£8.65
-------	-------	-------	-------

D



D 'Things To Do Today' Book

- Wire-bound with a daily planner per page
- Each page has space for 20 tasks which can be ticked when completed
- Each book contains 115 sheets, which are perforated for easy removal
- Complete with a reminders section

F01339		each	£4.37
--------	--	------	-------

E



E Receipt Book With Counterfoils

- High quality receipt book, containing 100 receipts & counterfoils
- Tear out slips are 102 x 65mm

SRECBK*		each	£2.02
---------	--	------	-------

* While stocks last

F



F Carbonless Duplicate Receipt Book

- Quality NCR paper, ruled feint and numbered 1-100, with index sheet, no carbon required
- 102 x 127mm

94530		each	£2.64
-------	--	------	-------



A Telephone Message Books

- Easy to use duplicate message book with space for written messages and tick boxes for action required
- Perforated for easy removal of top copy
- No carbon paper required

26034	200 Messages	each	£4.77
F01336	400 Messages	each	£9.17



A

B Address Record Book

- Combined telephone & fax reference book
- Laminated board with wire bound spine
- A-Z index with reinforced tabs
- A5 black

87110		each	£10.07
-------	--	------	--------



B

C Visitors Book & Refill Kit

- Records visitors details, date, name, company, car registration number, badge no., time in and time out
- 2000 entries per premium quality black padded binder with 3 ring mechanism
- Loose leaf sheets with clear mylar reinforced punch holes on every sheet
- Binder 230 x 340 x 40mm
- Refill contains 50 sheets

85710	Binder	each	£27.45
85801	Refill	each	£9.33



C

D Spiral Bound Duplicate & Triplicate Books

- Serially numbered with perforated tear out pages
- Wire fixing allows cover to be folded flat
- Comes with index card which can be used as a writing shield between each set
- No carbon paper required
- Duplicate books have 100 numbered sets
- Triplicate books have 50 numbered sets

Duplicate Books

F01340	102 x 127mm	each	£4.79
F01342	A4 210 x 297mm	each	£15.35

Triplicate Books

F01344	210 x 127mm	each	£10.87
--------	-------------	------	--------



D

E Duplicate Books

- Indexed at the front to keep a record
- Carbon paper supplied
- First page feint ruled, backing copy plain
- 100 numbered sets per book

F04094	102 x 127mm	each	£1.25
F04095	210 x 127mm	each	£2.39



E



CALL US ON 01527 878348



VISIT WWW.FORWARDPRODUCTS.CO.UK

A



A A4 Starter Sketch Book

- Excellent general purpose book at a very economical price
- 40 pages of 100gsm quality acid free drawing cartridge
- 280 micron thick black covers

EA4SSB	pk 100	£59.95
--------	--------	--------

B



B Laminated Sketch Books

- Manufactured with a 380 micron laminated cover for extra durability
- 40 pages of 140gsm quality acid free drawing cartridge paper
- Standard colour black
- Other colours available when ordering large quantities (Blue, Burgundy and Green)

ELSBA4	A4	pk 40	£34.99
--------	----	-------	--------

C



C Traditional Spiral Sketch Books

- High quality sketchbooks suitable for all mediums
- 30 sheets of 100gsm acid free drawing cartridge paper
- 280 micron black cover

ETSBA4	A4	each	£2.79
ETSBA3	A3	each	£4.29

D



D Soft Cover Spiral Bound Sketch Books

- Smart sketch book with durable black laminated covers
- 50 pages of 140gsm acid free drawing cartridge paper
- Give your pupils a sense of pride in their sketches

ESBKA4	A4	each	£3.29
--------	----	------	-------

E



E Premium Hard Backed Sketch Books

- Superior quality hand made sketch books
- 380-micron Linen effect black covers
- 96 sheets of 140gsm all media cartridge paper

EPSBA4	A4	each	£4.89
EPSBA3	A3	each	£11.78



A Standard A1 Flipchart Pads

- Bleed resistant white paper for use with flipchart markers
- Perforated at head for easy removal of unused sheets
- Fit all standard flipchart easels
- 40 sheets per pad
- Punched 2 holes at top

DFPSTD	Plain	pk 5	£15.40
DFPGRD	Feint Gridlines	pk 5	£29.08



A

B Specialist A1 Flipchart Pads

- High quality 80gsm paper
- Perforated at head for easy removal of sheets
- 30 leaves per pad
- Literacy pads ruled with 4 sets of learn to write guides
- Numeracy pads ruled with 50mm feint squares
- Lines pads are 50mm ruled
- Punched with 2 holes at the top

DFPLTW	Literacy	pk 5	£27.67
DFPNUM	Numeracy	pk 5	£27.67
DFP50S	Lined 50mm	pk 5	£27.67



B

C Selfstick Fold Out Flipchart Pads

- Self stick repositionable adhesive flipchart pads
- Just peel off each sheet and stick to the wall or door
- No need for pins or tape
- Lightweight, complete with a sturdy back card and table pad
- Pad comes flat and instantly converts for table top presentation
- High quality paper prevents pen bleeding through
- Perforated for easy tear off
- 20 sheets of plain paper per pad

DFPSFO	each	£12.60
--------	------	--------



C

D A1 Self Adhesive Flipchart Pads

- Use like sticky notes
- No need for adhesive tape, the self-adhesive strip across the back of each sheet allows them to be stuck on walls and windows around the room
- 30 sheets of 75gsm bleedproof paper

DFPSA	pk 2	£36.05
-------	------	--------



D



CALL US ON 01527 878348



VISIT WWW.FORWARDPRODUCTS.CO.UK

A



A Breakaway Lanyards

- Lanyards with breakaway safety feature
- 8mm strap
- Trigger clip

SLANBK10	Black	pk 10	£3.98
SLANRD10	Red	pk 10	£3.98
SLANBL10	Navy Blue	pk 10	£3.98
SLANGN10	Dark Green	pk 10	£3.98
SLANYW10	Yellow	pk 10	£3.98

B



B Pre Printed Breakaway Lanyards

- Quality 15mm breakaway lanyards with safety breakaway
- Trigger clip

LANSTA10	Staff (Grey)	pk 10	£11.56
LANVISRD10	Visitor (Red)	pk 10	£11.56

C



C Landscape ID Badge Holders

- Rigid card holders
- Landscape
- Ideal for passes and security badges

IDCHRLBK	Black	pk 50	£10.13
IDCHRLBL	Blue	pk 50	£10.13
IDCHRLRD	Red	pk 50	£10.13
IDCHRLGN	Green	pk 50	£10.13

D



D Combi Clip ID Badge Holders

- Combi clip with both pin and clip fasteners attached
- Front and side opening to insert cards
- Landscape
- Takes insert size 54 x 90mm (not included)

150312	Combi Clip	pk 50	£24.23
--------	------------	-------	--------



A Hardboard Clipboards

- Smooth surface offers an enhanced writing platform

F01304	A4	each	£1.99
F01305	A3	each	£2.74



A

B PVC Clipboards

- Rigid PVC covered board with heavy duty clip and pen holder
- Suitable for foolscap and A4 papers
- Double clipboard has a foldover cover and inside pocket

F01296	Black	each	£1.87
F01297	Blue	each	£1.87
F01298	Red	each	£1.87
F01300	Foldover Black	each	£2.29
F01301	Foldover Blue	each	£2.29
F01302	Foldover Red	each	£2.29



B

C Leather Look Zipped Ring Binder

- Grained leather look
- Internal document, cards and CD pockets
- 4 ring binder mechanism and spring clip
- Pad slot and pen holder
- Rear zipped pocket & zip round enclosure
- W260 x D50 x H360mm

29260	Leather Binder	each	£24.03
-------	----------------	------	--------



C



CALL US ON 01527 878348



VISIT WWW.FORWARDPRODUCTS.CO.UK

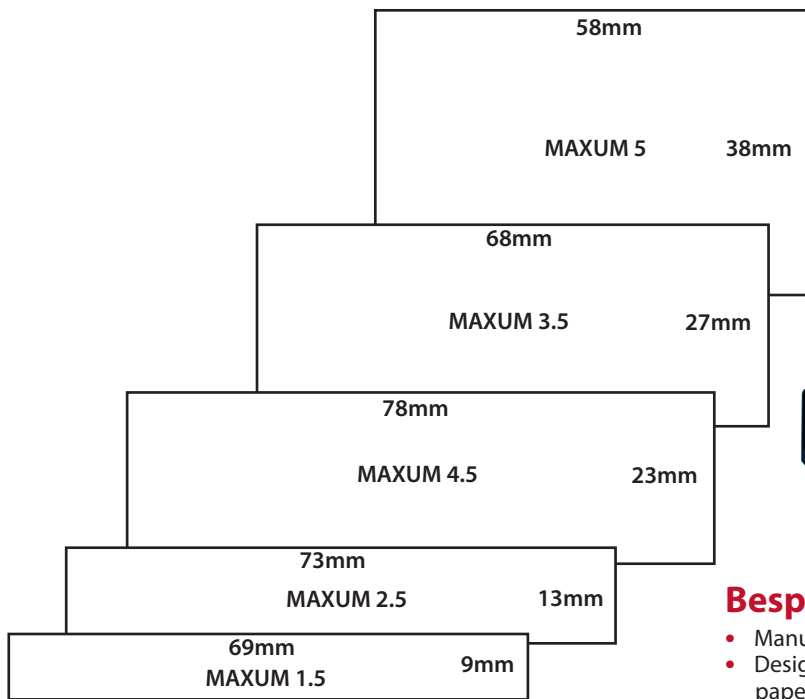

Bespoke Self Inking Stamps

- Manufactured from high impact plastic
- Design provides a smooth transition from pad to paper
- The prices shown include the cost of your custom made die
- When the impression fades simply replace the pad
- Replacement pads available in Black, Red, Blue and Green
- Stamps are supplied with black ink unless requested otherwise

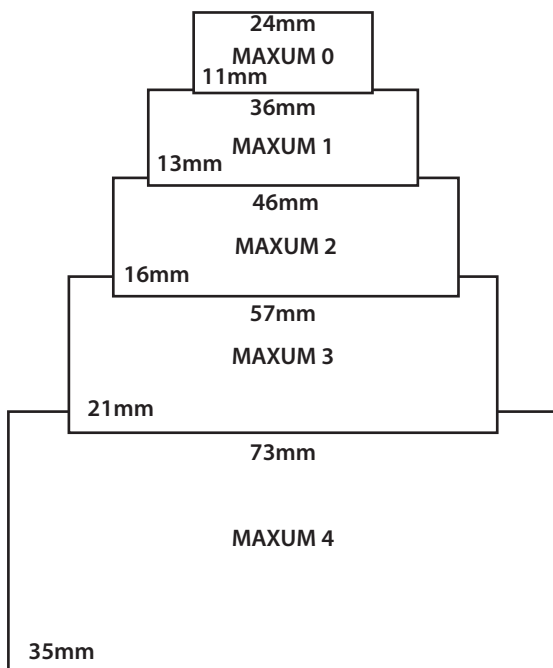

Just fax or email us with the details you require and we will send you a proof to approve.

Stamp Code	Stamp Size	Stamp Price	Pad Code	Pad Price
MAXUM5	58 x 38mm	£61.09	MAXPAD5	£6.06
MAXUM4.5	78 x 23mm	£55.64	MAXPAD4.5	£6.43
MAXUM4	73 x 35mm	£71.54	MAXPAD4	£6.06
MAXUM3.5	68 x 27mm	£33.89	MAXPAD3.5	£5.37
MAXUM3	57 x 21mm	£42.69	MAXPAD3	£4.65
MAXUM2.5	73 x 13mm	£44.15	MAXPAD2.5	£5.16
MAXUM2	46 x 16mm	£33.25	MAXPAD2	£4.55
MAXUM1.5	69 x 9mm	£32.30	MAXPAD1.5	£5.76
MAXUM1	36 x 13mm	£36.04	MAXPAD1	£4.01
MAXUM0	24 x 11mm	£23.06	MAXPAD0	£4.27



A Customised Rubber Stamps

- Natural rubber composition gives the best possible ink transfer
- Simply fax or email your required design to us and we'll send you a proof to approve



A

70mm		STRS23 - £62.16	STRS24 - £62.07	STRS25 - £63.35	STRS26 - £67.03	STRS27 - £70.88	
50mm		STRS18 - £54.32	STRS19 - £63.79	STRS20 - £60.14	STRS21 - £62.07	STRS22 - £63.35	
38mm		STRS13 - £47.65	STRS14 - £43.92	STRS15 - £49.23	STRS16 - £56.92	STRS17 - £62.07	
25mm	STRS7 - £25.56	STRS8 - £31.81	STRS9 - £37.50	STRS10 - £37.48	STRS11 - £41.44	STRS12 - £42.68	
12mm	STRS1 - £22.01	STRS2 - £22.01	STRS3 - £22.58	STRS4 - £24.62	STRS5 - £27.21	STRS6 - £29.68	
	Start Here	25mm	50mm	75mm	100mm	125mm	150mm

B Stamp Pads & Refill Ink

Standard Pads - 110 x 70mm

25203	Blue	each	£4.73
25205	Black	each	£4.73
25208	Red	each	£4.73

Refill Ink - 28ml Bottles

25105	Black	pk 10	£9.99
-------	-------	-------	-------



B



CALL US ON 01527 878348



VISIT WWW.FORWARDPRODUCTS.CO.UK

A

Assortment A



Assortment B



A Motivational Stamps

- Great for encouraging pupils
- Pre-inked stamps can be easily re-inked
- All stamps measure 22 x 22mm
- Thousands of impressions before re-inking

49837	Verbal Feedback Given	each	£7.00
49402	Assorted Pack A	pk 4	£21.22
49403	Assorted Pack B	pk 4	£21.22

B



**COPY
ENTERED**

B Self Inking Word Stamps

- 100,000 print sharp impressions before re-inking is required
- Soft touch handle and an impression cover
- Lifetime guarantee

EP1006	Copy	each	£13.01
EP90251	Entered	each	£13.01

Refill Ink

EP99022	Red 10cc	each	£3.98
---------	----------	------	-------

C



12 NOV 2018

C Self Inking Mini Dater Stamp

- 12 year date band
- Imprint height 3.8mm

37284	Stamp	each	£6.41
30489	Replacement Pad	pk 2	£6.38

D



PAID
12 NOV 2018
RECEIVED
12 NOV 2018

D Self Inking Mini Text and Date Stamp

- Combines a 3.8mm date with either RECEIVED or PAID
- Prints the day, month and year (12 year date band)
- Date prints in red, the text prints in blue

30116	RECEIVED Stamp	each	£20.41
30117	PAID Stamp	each	£20.41
30491	Replacement Pad	pk 2	£7.44



A Plastic Binding Combs

- 21 ring
- A4 length
- Available in black and white

Black Code	White Code	Capacity	Sheets		
COMB6BK		6mm	25	pk 100	£2.11
COMB8BK		8mm	45	pk 100	£5.89
COMB10BK	COMB10WH	10mm	65	pk 100	£5.95
COMB12BK		12mm	105	pk 100	£3.90
COMB14BK		14mm	125	pk 100	£4.10
COMB16BK		16mm	145	pk 100	£6.67
COMB20BK		20mm	155	pk 100	£7.16
COMB25BK		25mm	220	pk 50	£10.79
COMB28BK		28mm	240	pk 50	£11.56

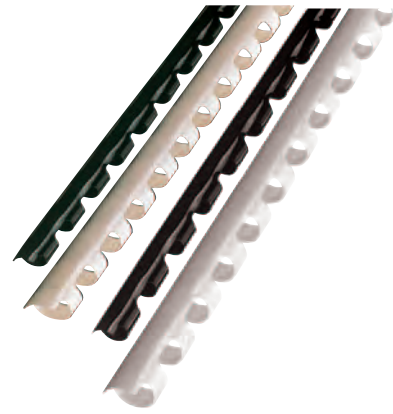

A

B Slide Binders

- A4 length, squared corners

		Sheet Capacity			
SLB5BK	5mm Black	40	pk 100	£8.70	
SLB5BL	5mm Blue	40	pk 100	£8.70	
SLB7BL	7mm Blue	70	pk 100	£7.99	
SLB10BK	10mm Black	90	pk 100	£11.56	

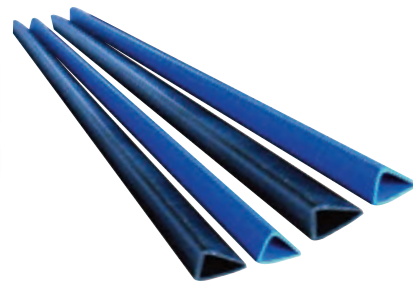

B

C Clear A4 Binding Covers

- Enhance and protect your documents
- Strong durable clear PVC

PVCA4150	140 micron	pk 100	£7.71
PVCA4180	180 micron	pk 100	£8.80
PVCA4240	240 micron	pk 100	£11.14



C

D Plain Paper Copier Film A4

- High quality photocopyable OHP film
- Transparent A4 film for overhead projectors
- Perfect for presentations
- Can be printed in colour or black

OHPTC	pk 100	£13.46
-------	--------	--------



D

E GBC A4 Thermal Binding Covers

- High quality pre-glued covers for use in thermal binding machines to produce your own professional reports
- Royal blue, leathergrain backs
- 15 sheet capacity
- 1.5mm spine

21919	pk 100	£53.59
-------	--------	--------



E



CALL US ON 01527 878348



VISIT WWW.FORWARDPRODUCTS.CO.UK

A



A Yellow Sticky Notes

- Ideal for messages and 'quick' notes
- For use in the home or office
- Notes will stick to most surfaces
- Each pad contains 100 sheets

10500	40 x 50mm	pk 12	£1.52
10501	50 x 75mm	pk 12	£3.82
10502	75 x 75mm	pk 12	£2.35
10503	75 x 125mm	pk 12	£3.79

B



B Rainbow Sticky Notes

Neon

- 40 x 50mm contains 50 sheets per colour
- 75 x 75mm and 125 x 75mm contain 80 sheets per pad
- Packs of 12 contain 3 each of yellow, green, pink and orange

Pastel

- Contain 100 sheets per pad
- Packs of 12 contain 3 each of yellow, pink, blue and green

Neon

F01224	40 x 50mm	pk 3	£1.33
10508	75 x 75mm	pk 12	£5.83
F01350	125 x 75mm	pk 12	£9.30

Pastel

10509	75 x 75mm	pk 12	£4.99
F01349	125 x 75mm	pk 12	£9.25

C



C Sticky Note Cubes

- Size 75 x 75mm
- Yellow and pastel cubes have 400 sheets
- Neon cubes have 320 sheets

F01346	Yellow 75 x 75mm	each	£2.82
F01347	Pastel 75 x 75mm	each	£2.82
F01348	Neon 75 x 75mm	each	£2.82

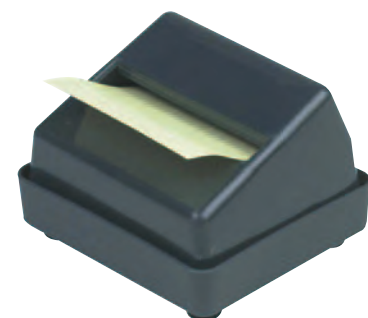

D



D Sticky Z Notes & Dispenser

Z Notes

- A continuous pad of notes - each one pops up automatically!
- 75 x 75mm
- 100 sheets per pad

Dispenser

- One handed operation
- Non slip, anti-scratch feet

F02161	Sticky Notes	pk 12	£6.63
21672	Dispenser	each	£7.26



A Yellow Post-it Notes

- The original high quality repositionable notes
- Available in three sizes
- 100 sheets per pad

F01401	38 x 51mm	pk 12	£4.35
F01403	76 x 76mm	pk 12	£10.94
F01417	76 x 127mm	pk 12	£15.07



A

B Post-It Notes - Energetic Colours

- A mixture of strong colours ranging from yellow to fuschia to make all your messages stand out
- Available in 3 sizes
- Notes made from PEFC certified paper fibres
- 100 sheets per pad

87121	38 x 51mm	pk 12	£10.22
87123	76 x 76mm	pk 6	£11.64
87125	76 x 127mm	pk 6	£14.42



B

C Post-It Notes - Dreamy Colours

- An unexpected composition of soft blue and delicate green colours to express your thoughts.
- Available in 3 sizes
- Notes made from PEFC certified paper fibres
- 100 sheets per pad

87122	38 x 51mm	pk 12	£11.18
87124	76 x 76mm	pk 6	£12.14
87126	76 x 127mm	pk 6	£14.54



C

D Super Sticky Lined Post-it Notes

- Brightly coloured sticky notes with faint lines for neat note taking
- Contains Yellow, Fuchsia and Mediterranean blue notes
- 90 sheets per pad
- Renewably resourced adhesive, 60% made from plant that replenishes annually

99884	101 x 152mm	pk 3	£13.70
99885	101 x 101mm	pk 6	£18.04



D



CALL US ON 01527 878348



VISIT WWW.FORWARDPRODUCTS.CO.UK

A



A Post-It Super Sticky Notes

- Asparagus, Mediterranean Blue and Fuchsia
- PEFC certified with environmentally friendly adhesive
- 90 sheets per pad
- Size: 76 x 76mm

38086	Asparagus	pk 6	£10.99
98405	Fuchsia	pk 6	£10.99

B



B Post-it Note Cubes

- Post-it Note cubes in neon or pastel shades
- Easily seen on desk or by phone
- 450 sheets per cube
- Size 76 x 76mm

23162	Yellow	each	£6.90
87136	Energy Colours	each	£7.21

C



C Post-It Note Recycled Tower Yellow

- These recycled Post-it Notes come supplied in a handy tower dispenser
- Pack contains 16 pads and each pad contains 100 sheets
- Size: 76 x 76mm
- Colour: canary yellow
- Adhere to most surfaces and remove cleanly

10065	Canary Yellow	pk 16	£20.74
-------	---------------	-------	--------

D



D Stick'N Shapes

- Get noticed with these fun shapes
- 50 sheets per pad
- Size 70 x 70mm

49838	Arrow	pk 12	£7.95
49869	Heart	pk 12	£7.95
79170	Speech Bubble	pk 12	£7.95



A Sticky Index Tabs

- Repositionable adhesive tabs ideal for marking, tabbing, highlighting and colour coding all your important information
- Packs of 4 colours, 40 tabs per colour

F01225	Transparent	each	£2.59
F01226	Neon	each	£3.70



A

B Post-It Index Tabs

- Easy to write on transparent surface
- Repositionable
- Standard pack contains 96 arrows and can be used to refill any post-it index dispensers
- Portable pack contains 100 arrows and will fit neatly into diaries or bags
- Size: 12mm (1/2") wide
- Double sharpeners are suitable for jumbo pencils

50879	Standard Arrows	each	£5.73
F06334	Portable Arrows	each	£4.82



B

C Post-It Filing Tabs

- Can be repositioned as needed
- Made of durable material to withstand wear and tear
- 6 tabs per colour (blue, yellow, green & red)
- Angled tabs - easy to see from above suspension filing
- Standard tabs - ideal for files, ring binders and project folders

93620	Standard Tabs	each	£4.97
93619	Angled Tabs	each	£4.97



C

D Concord Record Card Ruled

- 152 x 102mm
- Assorted Colours
- Ruled revision cards

16199		each	£1.32
-------	--	------	-------

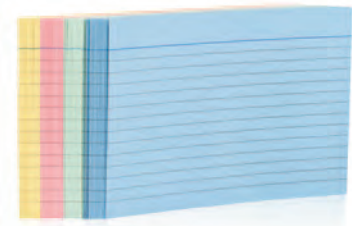

NEW!

D

E Concord Wirebound Revision Cards

- 100 Sides
- Wirebound ruled revision cards
- Cover colour may vary

16118	White Pages	each	£1.32
16119	Assorted Colour Pages	each	£1.32



NEW!

E



A Swash Triangular Barrel HB Pencils

- High quality triangular shaped HB pencils, specially formulated to provide excellent writing, sketching and shading properties
- Chunky size is ideal for younger children or those with learning difficulties
- Strong, break resistant leads makes them ideal for school use

SWJP12	pk 12	£4.12
--------	-------	-------



B Staedler Noris Club Triplus Jumbo Triangular HB Pencil

- Learner's pencil in jumbo ergonomic triangular shape for easy grip
- Ideal for first writing and drawing exercises
- Break-resistant, super bonded, special lead formulation
- Wood from certified, sustainably managed forests

119T48	pk 48	£27.18
--------	-------	--------



C Lyra Ferby Triangular Barrel Jumbo Graphite Pencils

- The famous 'Ferby' - chunky, broad pencils for younger children
- A half length graphite pencil in a natural wood finish
- Jumbo triangular grip for easy handling
- Supplied in handy re-usable tubs

971C36	Barrel Jumbo	pk 36	£18.54
--------	--------------	-------	--------



D Stabilo Easy Graph Triangular Barrel Pencils

- HB pencils with triangular barrels and unique non-slip moulds
- Available in right and left hand versions or a mixed classpack with 42 right handed and 6 left handed pencils

ST321LH	Left Hand	pk 6	£5.86
ST321RH	Right Hand	pk 12	£10.95



E Staedler Tradition 110 Pencils

- Popular school pencils
- Jet-bonding makes for greater strength, break resistance, and slow wear
- Made from Californian Cedar Wood
- Great for art & craft

10496	HB	pk 12	£4.63
10495	B	pk 12	£4.60
10494	2B	pk 12	£5.47
10492	4B	pk 12	£4.35



A Eziglide Premium HB Pencils

- Superb quality writing, drawing and sketching HB school pencils
- Quality alternative to Staedtler
- Excellent for all types of children's handwriting needs with break-resistant and super-bonded HB leads

FEHS12	pk 12	£1.26
FEHS150	pk 150	£10.59
FEHS600	pk 600	£41.33
FEHS1500	pk 1500	£95.39

SWITCH & SAVE



B Premium HB Classroom Pencils

- High quality HB classroom pencils, suitable for writing and drawing
- Tough construction for fewer breakages, and less time spent sharpening!
- Rigorously tested to ensure your pupils are using the best quality pencils
- Manufactured from grade 1/2 hardwood from responsibly managed sources

C112	pk 12	£0.62
C1144	pk 144	£6.52
C1500	bx 500	£19.39

- Eraser tipped HB pencils for correction

C212	Eraser Tipped HB	pk 12	£0.79
------	------------------	-------	-------

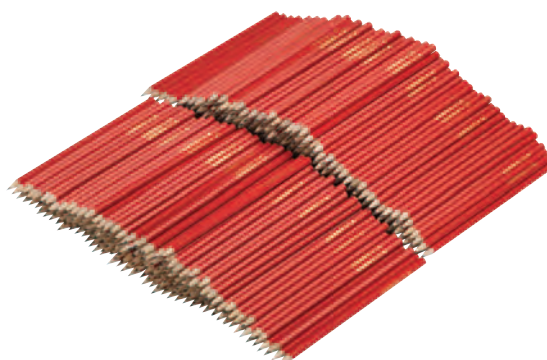

B

C Staedtler Noris Pencils

- The classic yellow and black pencil
- Available in 2B, H, 2H and HB
- Pack of 1500 HB supplied in a Gratnell's Tray
- Ideal for classroom use and art & craft

1212B	2B	pk 12	£1.95
121H	H	pk 12	£1.95
1212H	2H	pk 12	£1.95
121HB	HB	pk 12	£2.17
121LST	HB	pk 150	£16.95
121HLS5	HB	pk 600	£58.94
12110G	HB	pk 1500	£139.62



C

D Papermate Mechanical Pencil

- Twist action pencil with pocket clips and erasers
- HB Polymer lead encased in a cushioned spring design to minimise breakage
- 0.7mm point
- Available in assorted neon barrel colours

F01445	Assorted Neon	pk 12	£7.02
--------	---------------	-------	-------



D

E Half Pencils

- Pocket length hexagonal blacklead pencils
- Pre-sharpened for immediate use
- Unpainted wooden barrel
- Ideal for use with compasses

27026	Half Pencils	pk 144	£5.13
-------	--------------	--------	-------



E

Classmaster



Don't let a tight budget hold back your student's creativity

Pre-sharpened High-quality Wood with 3mm Lead

Comfortable Hexagonal Barrels

Excellent Blending and Laydown

Great value colouring pencils



Code	Description	Pack	Price
ECP12	Pack of 12 - 12 Colours	12	£1.20
ECPCP	Classbox of 288, 12 Colours	288	£21.85
ECP500	Classbox of 500, 12 Colours	500	£35.95

Don't forget your erasers and sharpeners

C30	Plastic Erasers, 60 x 20 x 16mm	20	£3.51
PSM150	Metal Single Hole Sharpener	50	£8.59
DPSM212	Double Hole Canister Sharpener	24	£21.38

Plastic Erasers
Erases pencil from paper without smudges or tears.



Graphite Pencils
Contains quality HB lead in standard sized hexagonal barrels



Canister Double Hole Sharpeners
Keep work areas free from shavings.



A Colourworld Colouring Pencils

- The colourworld pencils are full size and contain an assortment of coloured leads

CWCOL12 pk 12 £0.95



NEW!

A

B Lyra Ferby Triangular Barrel Colouring Pencils

- The famous 'Ferby' pencils
- A half length colouring pencil in a natural wood finish
- Triangular Grip for easy handling
- Vibrant, opaque colours

970H96 pk 96 £43.24



B

C Lyra Jockey Jumbo Pencils

- Lyra's Jockey Jumbos are exceptionally good value
- Chunky hexagonal pencils for younger children
- Available in packs of 12 or classpacks of 144 in a Gratnell's tray

LY813	Jockey Jumbo	pk 12	£3.87
LY820	Classpack	tray 144	£27.59



C

D Helix Oxford Colouring Pencils

- Quality full and half length pencils at excellent prices!
- Handy pack sizes

HX5010	Half Length	pk 12	£1.10
HX3010	Full Length	pk 12	£1.34
HX4010	Full Length	pk 24	£2.47



D

E Stabilo Colouring Pencils

- Full length colouring pencils with hexagonal barrels
- Available in class packs of 288 (12 colours)
- Supplied in storage tray

STCP288H* Stabilo pk 288 £33.13

* While stocks last



E

NEW!

A



A Staedler Essentials Colouring Pencils Classpack

- Supplied in a classpack of 288 these are high quality Staedler colouring pencils
- In a classic hexagonal shape

STECP288 pk 288 £29.99

B Eziglide Premium Colouring Pencils

- Superb quality assorted colouring pencils
- A quality alternative to Staedler
- Excellent for all types of colouring
- 12 assorted high pigment colours
- Break-resistant and super-bonded leads

FEGCP12	pk 12	£1.41
FEGCP144	pk 144	£13.13
FEGCP288	pk 288	£25.22



C



C Staedler Noris Club Pencils

- Full length colouring pencils
- Available in wallets of 12, box of 185 or Gratnell's trays of 288 pencils
- Excellent quality for trouble free performance

NC12	Wallet	pk 12	£2.14
NC144	Box	pk 185	£23.16
NC288	Tray	pk 288	£42.17



A Swäsh Heavy Duty Electric Sharpener for 7-12mm Pencils

- Adaptability for all pencils between 7mm and 12mm in diameter, this sharpener is perfect in the school classroom too
- Sharpens ALL pencils from 7-12mm
- Heavy duty motor for non-stop use
- Auto thermal cut-out system to prevent overheating
- Durable, long life sharpener with rubber suction feet to prevent slipping or marking surfaces

SJEPSHD each £82.08



A

Swäsh heavy duty electric sharpeners are powerful, durable, and optimised for the user's safety. Key features include auto-start and auto-stop, auto thermal cut out and a safety switch that cuts the power when the shavings tray is removed.

B Swäsh Heay Duty Electric Sharpener 8mm Diameter

- Adaptability for all pencils up to 8mm in diameter including triangular
- Professional mains-powered machine for non-stop use (with ultra safe features!)
- Powerful motor with an auto thermal cut-out system for your safety
- Auto-start when pencil is inserted and auto-stop when pencil is fully sharpened
- This durable, long life sharpener has rubber suction feet to prevent skidding on or marking any surface

SHDEPS each £58.62



B

C Westcott Ipoint Evolution Battery Powered Sharpener

- A stylish, verticle standing pencil sharpener that looks great on any desk
- Titanium bonded blades stay sharper for longer
- Easy view shaving reservoir
- Requires 4 x AA batteries (not included)

55030 Ipoint Battery each £10.58



C

D Rapesco 94 Pencil Sharpener

- A robust, good quality manual sharpener for office or classroom use
- Triple jaw clutch grip with self-feeding/autostop mechanism
- For standard 8-11mm pencils
- Supplied with desk clamp

RPS94 Manual each £8.56



D



A

A Metal Pencil Sharpeners

- Wedge shape single hole metal pencil sharpeners with finger grips
- Traditional style
- Accurate sharpeners

F02218	Metal Sharpeners	pk 20	£4.84
--------	------------------	-------	-------



B

B Pencil Sharpener Tubs

- Extra value pencil sharpeners in handy storage tubs
- 4 types available

PSM150	Metal Single	pk 50	£8.59
PSM225	Metal Double	pk 25	£8.59
PSP150	Plastic Single	pk 50	£3.14
PSP225	Plastic Double	pk 25	£4.17



C

C Canister Pencil Sharpeners

- Tough plastic barrels
- Choice of plastic single hole or aluminium double hole
- Assorted colours
- Keeps waste clean and tidy

DPS112	Plastic 1-Hole	pk 12	£5.93
DPSM212	Metal 2- Hole	pk 24	£21.38



D

D Triangular Pencil Grips Assorted Colours

- Pack of 10 vibrantly coloured pencil grips
- Triangular for encouraging comfortable and correct grip/writing posture
- Ideal for handwriting practice for young children
- Also useful for those with fine motor difficulties or those who struggle to hold pencils comfortably
- Fits all standard size pencils

TPG10		pk 10	£3.29
-------	--	-------	-------



A Helix Pencil Erasers

- Popular pencil erasers available in 3 different sizes
- Erases pencil drawings and writing from paper
- Ideal for everyday use in school

Large

Y92040 41 x 26 x 13mm pk 20 £2.95

Medium

Y94040 34 x 20 x 8mm pk 40 £2.86

Small

Y97040 30 x 21 x 6mm pk 72 £3.93



A

B Deluxe Pencil Erasers

- High quality plastic eraser in paper wrapper
- Economical erasers
- Available in 2 sizes

C30 60 x 22 x 16mm pk 20 £3.51

- India rubber erasers in class packs of 45

C20 32 x 23 x 9mm pk 45 £3.51



B

C Pencil Eraser

- Made from TPR, the C25 Eraser contains no PVC or latex
- The eraser is good quality and comes without a sleeve

C25 pk 20 £1.55



C

D WB Plastic Pencil Erasers

- The WB Eraser is an excellent quality eraser with a cardboard sleeve
- The eraser does not contain PVC or latex, being made from TPR plastic

WB PES pk 20 £1.75



D



CALL US ON 01527 878348



VISIT WWW.FORWARDPRODUCTS.CO.UK



A Micro Correct Pen

- Micro fine point correction pen
- Dense, quick drying white fluid
- Self sealing metal tip prevents drying out and spillage
- For all paper types, fax and photocopies
- Contains 12ml of fluid
- No mess, no fuss, no waste
- Trichloroethane free

XZL31W	Micro Pen	each	£2.63
--------	-----------	------	-------



B Tipp-Ex Rapid Fluid

- Unique wedge-shaped foam applicator allows for precise and broad correction
- Strokes on easily for all types of correction
- Fast drying fluid creates an even surface allowing you to re-write easily
- 20ml bottle

801296	pk 10	£16.38
48004X	each	£2.67



C Correction Fluid

- Cover mistakes quickly and effectively
- White multi-purpose fluid covers up type, ink, faxes, photocopies etc.
- Will not flake, chip or peel
- Dries smooth in seconds
- Supplied in 20ml bottles

CORFL	pk 10	£2.67
-------	-------	-------

Premium performance without the price tag



D Q Connect Correction Roller

- Produces a clean, quick and precise correction
- Transparent case indicates when the tape is low
- Unique 'tensioning' button tightens the tape
- The tape is 5mm wide and 8 metres in length

CORRL	each	£2.15
CORRL12	pk 12	£21.98



swäsh KOMFIGRIP Handwriting Pens

Swäsh KOMFIGRIP handwriting pens have been designed with the student in mind to aid and improve their handwriting.

Perfect for left and right handers!

Each pen features a triangular grip to encourage correct writing posture and high-quality, quick-drying, washable ink. Plus, with a 14-day cap-off time, these pens last and write for longer, offering great value for money.

Writes Better Longer

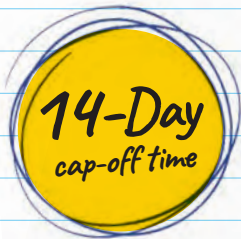

Universal clear ventilated lids

Vibrant coloured indestructible barrels

Bonded end caps are impossible to remove

KOMFIGRIP triangular grip for correct posture

14-day cap-off time

Washable

Pressure resistant nibs

SUPER VALUE
CLASSTRAYS

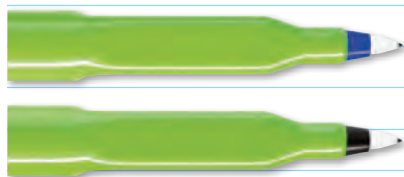

SKH12BL	Blue Handwriting Pens	Pk 12	£4.25
SKH300BL	Blue Handwriting Pens	Pk 300	£81.56
SKH12BK	Black Handwriting Pens	Pk 12	£4.25
SKH300BK	Black Handwriting Pens	Pk 300	£81.56

WITH SWÄSH KOMFIGRIP HANDWRITING PENS, YOU'LL ALWAYS GET THE BEST OUT OF YOUR STUDENTS.



CALL US ON 01527 878348



VISIT WWW.FORWARDPRODUCTS.CO.UK

A



A Manuscript Handwriting Pens

- Fantastic performance which outstrips more expensive brands!
- Comfortable triangular finger grip and silky smooth ink flow make this an ideal choice for promoting handwriting skills with your pupil

SHP10BK	Black	pk 10	£2.78
SHP10BL	Blue	pk 10	£2.78
SHP200BK	Black	pk 200	£49.99
SHP200BL	Blue	pk 200	£49.99

B



B Edding Handwriter

- Water-based ink for smooth, effortless writing
- Robust plastic tip writes at any angle
- Excellent ink flow, making it perfect for children's handwriting
- Suitable for right and left handed children learning to write
- Washable from skin & most textiles at 40°C

EDHWBK42	Black	tub 42	£11.83
EDHWBL42	Blue	tub 42	£11.83
EDHWBK200	Black	pk 200	£51.70
EDHWBL200	Blue	pk 200	£51.70

C



C Staedtler 309 Handwriting Pens

- Smooth and consistent ink flow for reliable classroom use
- Moulded grip prevents fingers from slipping and helps with writing control
- Long write-out length
- Medium 0.6mm tip
- Available in tubs of 50 or bulk packs of 100 & 200

STH50BK	Black	pk 50	£23.89
STH50BL	Blue	pk 50	£23.89
STH100BK	Black	pk 100	£47.72
STH100BL	Blue	pk 100	£47.72
STH200BK	Black	pk 200	£87.79
STH200BL	Blue	pk 200	£87.79



A EziGlide Handwriting Pen

Effortless and comfortable handwriting with this smooth flowing handwriter
High quality, hardwearing polyacetal tip to give smooth effortless writing

- Designed to develop good handwriting skills
- Suitable for right or left handed children, learning to write
- Excellent ink flow making it perfect for children's handwriting
- Large ink reservoir to increase life of pen
- Water based non-toxic ink
- Ventilated safety cap
- Line width 0.6mm
- Available in black or blue classpacks of 200

EGHW200BL* Blue pk 200 £21.59

* While stocks last



A

B Berol Handwriting Pens

- Used by over 2 million school children daily!
- Designed to help children achieve good writing standards

HPBXBK Classpack Black pk 200 £62.16

HPBXBL Classpack Blue pk 200 £62.16



B

C Scribe Handwriting Pens

- Excellent value nylon tipped handwriters with special durable nib and easy flow ink

SHW12BK Black pk 12 £1.90

SHW12BL Blue pk 12 £1.90

SHW204BK Black pk 204 £27.77

SHW204BL Blue pk 204 £27.77



C



A

A Bic 4 Colour Original Ballpen

- An old favourite with four colours and a blue barrel
- Contains black, blue, red and green ink available at the click of a button
- Medium tip

BBPENM36 pk 36 £39.99

NEW!



B

B Eziglide Ball Pens

- Performance - Eziglide's precision engineered unique tip ensures an effortless writing experience
- Ink technology - Eziglide uses ultra-glide ink to provide the smooth writing sensation
- Safety - Eziglide's ventilated safety cap conforms to BS7272
- Medium tips

EPBK50	Black	pk 50	£4.99
EPBL50	Blue	pk 50	£4.99
EPRD50	Red	pk 50	£4.99
EPGR50	Green	pk 50	£4.99
EPPU50	Purple	pk 50	£4.99
EPPK50	Pink	pk 50	£4.99
EPOR50	Orange	pk 50	£4.99
EPAS50	Assorted	pk 50	£4.99

LOWEST PRICE



C

C Standard Ball Pens

- Ball pens boxed in 50's with medium tips
- Available in black, blue, red, green

Economy (brand may vary)

26039WX	Blue	pk 50	£2.78
26040WX	Black	pk 50	£2.78
26041WX	Red	pk 50	£2.78

Standard

BPMBK	Black	pk 50	£3.93
BPMBL	Blue	pk 50	£3.93
BPMRD	Red	pk 50	£3.93
BPMGR	Green	pk 50	£3.93

D



D Bic Ball Pen

- The world's best selling ball pen, now at excellent prices!
- Hexagonal barrel for comfortable grip
- Medium tips

BBMBK	Black	pk 50	£7.59
BBMBL	Blue	pk 50	£8.24
BBMRD	Red	pk 50	£8.08
BBMGR	Green	pk 50	£9.67



A Retractable Ball Pens

- Retractable ball pen with soft rubberised grip to reduce writing fatigue
- Medium tip and a barrel that matches the ink colour

F00267	Black	pk 10	£5.27
F00268	Blue	pk 10	£5.27
F00269	Red	pk 10	£5.27

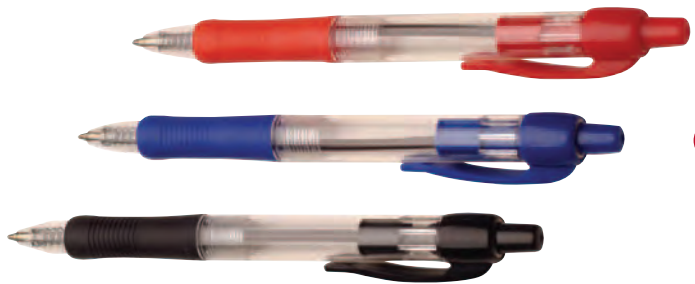

A

B Rubber Grip Stick Pen

- Comfortable high performance pen
- Rubber grip makes writing controlled & comfortable
- Medium tip

F02457	Black	pk 20	£4.83
--------	-------	-------	-------



B

C Delta Ballpoint Pens

- Transparent barrel for visible ink level
- Comfortable rubber grip in writing colour
- Instantly drying gel ink
- Medium tip

F00375	Black	pk 12	£10.95
F00376	Blue	pk 12	£10.95



C

D Ink Joy 100ST Ball Pens

- Triangular shape for comfort and control
- Transparent colour-tinted body for a refreshing look
- Medium tip 1.0mm

IJV150*	Violet	pk 12	£4.39
---------	--------	-------	-------

* While stocks last



D

E Staedtler Ballpoint Pen Stick 430 Medium

- Economical everyday ball point pens from Staedtler
- Extremely long lasting ink reservoir
- Comfortable hexagonal shape
- Durable stainless steel tip for smooth writing
- Medium 1.0mm tip for 0.35mm line width

ST430GR	Green	pk 10	£1.87
ST430BK	Black	pk 10	£1.87
ST430BL	Blue	pk 10	£1.87
ST430RD	Red	pk 10	£1.87



E

F Staedtler 432 Ball Pens

- Ballpoint pen in triangular shape for smooth writing performance
- Handy pack of 10 popular colours

SSTB432*	Ball Pens	pk 10	£3.02
----------	-----------	-------	-------

* While stocks last



F

A



A Schneider Ballpoint Pen Slider Edge Extra Bold

- Fantastic ballpoint pen for exceptionally smooth writing
- With Viscoglide® technology
- Quick drying ink for smudge proof writing & highlighting
- Comfy rubberised triangular barrel design
- Produced CO2 neutrally!

SBSEBK	Black	pk 10	£6.95
SBSEBL	Blue	pk 10	£6.95
SBSERD	Red	pk 10	£6.95
SBSEGR	Green	pk 10	£6.95
SBSEVI	Violet	pk 10	£6.95
SBSEPK	Pink	pk 10	£6.95
SBSELB	Light Blue	pk 10	£6.95
SBSELG	Light Green	pk 10	£6.95

NEW!

B



B Edding 2185 Crystaljelly Gel Pens

- The gel roller has a 0.7mm fine roller nib with a modern water-based and low-odour gel ink
- Extremely comfortable to hold due to its rubber grip
- Effortlessly draw or write for extended periods

2185RD	Red	pk 10	£6.49
2185BL	Blue	pk 10	£6.49
2185GR	Green	pk 10	£6.49
2185PU	Purple	pk 10	£6.49
2185PK	Pink	pk 10	£6.49
2185OR	Orange	pk 10	£6.49
2185GD	Gold	pk 10	£6.49
2185SI	Silver	pk 10	£6.49
2185AS	Assorted	pk 5	£3.30

C

REDUCED
50% OFF
TO CLEAR



C Uni-ball Gel Stick Pens

- Value gel ink roller ball for fatigue free writing
- Medium tip (produces 0.5 writing line)
- Lightweight barrel with triangular grip

UNI170RD*	Red	pk 12	£4.06
-----------	-----	-------	-------

* While stocks last

D

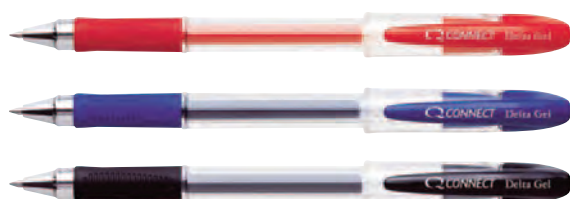

D Delta Gel Rollerball Pens

- Transparent barrel for visible ink-level
- Comfortable rubber grip in writing colour
- Instantly drying gel ink
- Medium tip

F00678	Black	pk 12	£10.90
F00679	Blue	pk 12	£10.90
F00680	Red	pk 12	£10.90



A Gel Rollerball Pens

- Stylish smooth writing gel rollerball pen.
- Rubber grip for extra comfort and control
- Fine tip

21716	Black	pk 10	£4.90
21717	Blue	pk 10	£4.90
21718	Red	pk 10	£4.90



A

B Pilot FriXion Erasable Rollerball Pens & Refills

- Deletes cleanly using friction
- The ink rubs away cleanly with the tail of the pen and re-writes immediately over the erased area
- 0.7mm Nib

SPFBK	Black Pens	pk 12	£17.79
SPFBL	Blue Pens	pk 12	£17.79
SPGR	Green Pens	pk 12	£17.79
SPVI	Violet Pens	pk 12	£17.79

PREFRBK	Black Refill	pk 3	£4.13
PREFRBL	Blue Refill	pk 3	£4.13
PREFRGR	Green Refill	pk 3	£4.13
PREFRVI	Violet Refill	pk 3	£4.13



B

C Laundry Markers

- Ideal for marking on linen. The ink will not run or fade even with repeated washing
- Fine 0.7mm bullet tip
- Instant drying
- Fade resistant and waterproof black ink

80450	Laundry Markers	pk 12	£21.54
-------	-----------------	-------	--------



C

D White Paint Markers

- This permanent paintmarker provides heavy duty and permanent white markings
- Will mark almost any surface
- Ideal for use in industry and both indoors and outdoors

14452		pk 10	£18.79
-------	--	-------	--------



D

E CD/DVD Markers

- Waterproof marker ideal for marking CD's and DVDs
- Bullet tip for precise writing

F02300	Black	pk 10	£5.78
--------	-------	-------	-------



E

A



A Q Connect Reception Pen

Pen attached by a chain to a solid base.

- Pen has 2 blue refills enclosed
- Easy to use adhesive base

F00233	Reception Pen	each	£7.54
11048	Blue Ink Refills	pk 10	£4.46

B



B Ink Cartridges

- Cartridges designed to fit most fountain pens
- Available in black and blue

52422	Black	pk 50	£2.04
52419	Blue	pk 50	£2.04

C

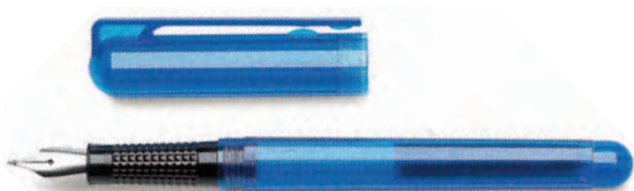

C Fountain Pens

- The medium steel nib and technically advanced feed system aid development of free-flowing writing
- Sturdy construction and no small parts
- Each pen is supplied with a blue ink cartridge

SPFEN		pk 12	£8.72
-------	--	-------	-------

D



D OHP Pens

- Produce an effective OHP display
- Black
- Fine 0.5mm nib

OHPPF	Permanent	pk 10	£7.67
-------	-----------	-------	-------

E



E Permanent Markers

- Low odour non toxic permanent markers, suitable for practically any surface
- Permanent ink dries quickly
- Bullet tip stroke width 2mm
- Chisel tip stroke width 2 - 5mm
- Assorted pack: 2 black, 1 blue and 1 red

Chisel Tip

26042	Black	pk 10	£4.35
-------	-------	-------	-------

Bullet Tip

26045	Black	pk 10	£4.35
26088	Assorted	pk 4	£2.55

F



F Anti-Dust Chalk

- Box of 144 sticks (white) or packs of 12 chalks (coloured)
- Handy pack sizes

54404	White	pk 144	£5.93
-------	-------	--------	-------



A Schneider 290 Maxx Flipchart/Drywipe Marker

- Unique flipchart marker that doubles up as a drywipe marker
- No more accidental whiteboard stains from using the wrong marker pen!
- Strong colours and quick drying ink for powerful flipchart presentations
- 2-3 day cap-off time for longer life
- Non squeak design, and odourless ink
- Toluene and Xylene free

SCHFBK	Black	pk 10	£9.92
SCHFASS	Assorted	pk 4	£3.74



A

B Flipchart Markers

- Quick drying, bleed-through resistant
- Xylene free, water soluble ink
- 2mm bullet tip

815106	Assorted	pk 4	£2.47
--------	----------	------	-------



B

C FineLiner Pens

- An ultrafine tip writes and draws fine and precisely - ideal for ruling and stencilling
- Classic fine line writer 0.4mm line width
- Write out length over 1300 metres

25007	Black	pk 10	£3.50
25008	Blue	pk 10	£3.50
25009	Red	pk 10	£3.50



C

D Staedtler Triplus® Fineliner

- Fineliner in ergonomic triangular shape for relaxed & easy writing
- DRY SAFE – can be left uncapped for days without drying up
- 0.3mm point
- 4 specially selected colours for school marking (orange/green/pink/purple.)

SSTTRFL*		pk 4	£3.29
----------	--	------	-------

* While stocks last



D

E Stabilo Point 88 Fine Liner Pens

- Metal encased tip for extra long life
- Fast drying ink does not smudge
- Available as an assorted pack of 10
- Make an impact and improve your memory with colour

SFLPP88	Assorted	pk 10	£4.68
---------	----------	-------	-------



E

EZIGLIDE features:

- High quality, strong hydrocarbon tips, ideal for classroom use

- Specially designed for drawing and art applications
- Excellent colour laydown which is bleed-resistant on most papers
- Non-toxic, washable, water based ink



A EZiGlide ColourFun Broad or Fine Felt Tip Classpacks

Premium quality felt tips, which perform as well as the 'leading brand' at a very competitive price point!

- High quality, hardwearing round ended polyester fibre tip
- Ideal for detailed colouring and drawing
- Transparent ink allows additional colours to be created with overlays of brighter colours
- Large ink reservoir to increase life of pen
- Ventilated safety cap
- Fine tip line width is 0.6mm and broad tip line width is 1-2mm
- Fine or Broad Tip in assorted packs of 288

CCFT12	Fine	pk 12	£2.10
CCFT36	Fine	pk 40	£7.54
CCFT288	Fine	pk 288	£44.98

CCBT12	Broad	pk 12	£2.10
CCBT36	Broad	pk 40	£7.54
CCBT288	Broad	pk 288	£44.98

B EZiGlide ColourFun Jumbo Markers

- Transparent ink allows colours to be created with brighter colours overlaid
- Large ink reservoir to increase life of pen
- Chisel Tip line width is 5-7mm
- Chisel Tip assorted pack of 144

EGJMAC*	Chisel Tip	pk 144	£19.54
---------	------------	--------	--------

* While stocks last

C EZiGlide ColourFun Conical Felt Tip Markers

- Ideal for line drawing and brush strokes
- Ventilated safety cap
- Line width 1-2mm
- Available in an assorted classpack of 288

EGCC288*	pk 288	£21.15
----------	--------	--------

* While stocks last



A Berol Felt Tips

Colourbroad

- 1.7mm fibre tip for colouring larger areas

CBW12	Wallet 12	£3.84
CBT42	Tub 42	£11.69
CBCP	Classpack 288	£61.53

Colourfine

- 0.6mm fibre tip for detailed work

CFW12	Wallet 12	£3.84
CFT42	Tub 42	£11.69
CFCP	Classpack 288	£61.53



A

B Berol Colourmarker Felt Tips

- Jumbo bullet tips for lettering, posters and flip charts
- Contains 12 assorted colours

CMB12	pk 12	£6.25
CMBP	pk 144	£68.17



B

C Edding Colour Markers Assorted

- Brilliantly soft fibre pens
- Soft nib can write on most textiles
- 3 day cap-off technology prevents nibs from drying out
- Colours are intermixable until ink dries

EDCB12	Bullet Tip	pk 12	£4.27
EDCB144	Bullet Tip	pk 144	£47.60
EDCC12	Chisel Tip	pk 12	£4.27
EDCC144	Chisel Tip	pk 144	£47.60



C

D Stabilo Power Broad Felt Tips

- Broad, 2mm tip for colouring larger areas
- Vibrant, washable colours
- Super resilient tips

STPW12	wallet 12	£2.50
SPB144	Classpack in Tray 144	£36.09



D

E

E Stabilo Power Max Broad Felt Tips

- Thick, durable, push resistant XL-tip (line width approx. 3mm)
- Up to 8 weeks cap off time
- Grattnell's tray, with 96 pens in 12 colours

SPMBFT96	Classpack in Tray	pk 96	£38.09
----------	-------------------	-------	--------



F

F Stabilo Trio Fine Felt Tips

- Stabilo fine fibre tips with 0.7mm tips
- Vibrant, washable colours

STTR12	Fine	wallet 12	£2.50
--------	------	-----------	-------

G Felt Tip Pens

- Conforms to EN71
- Contains washable non-toxic inks

Fine Tip

FELT10	Fine	wallet 10	£0.57
FELT100T	Fine	tub 100	£5.88

- Jumbo felt tip pens for posters and larger areas of colour work

FELTJ10	Jumbo	wallet 10	£2.19
---------	-------	-----------	-------



G

A



A Stabilo Boss Highlighter Classpack

- The original vibrant highlighter in an economy bulk pack
- Long life & high cap-off time

19873	½ Yellow & ½ Asst	pk 48	£29.67
19874	Assorted	pk 48	£29.67

B



B Stabilo Boss Highlighters

- Brand leading highlighter with improved ink which is quick drying and longer lasting
- Single colours or assorted wallets

7054	Orange	pk 10	£6.95
7024	Yellow	pk 10	£6.95
7031	Blue	pk 10	£6.95
7033	Green	pk 10	£6.95
7056	Pink	pk 10	£6.95
7058	Lilac	pk 10	£6.95
704	Assorted	pk 4	£3.56
706	Assorted	pk 6	£4.74
708	Assorted	pk 8	£5.92

C



C Mini BOSS Highlighters

Small versions of BOSS Original highlighters

- Fun mini highlighters that fit in your pocket
- Perfect for home, school or the office

ST075	Highlighters	pk 5	£3.51
-------	--------------	------	-------

D



D Economy Highlighters

- Chisel tipped highlighters suitable for paper and thermal faxes

(Brand may vary)

F01116WX	Assorted	pk 4	£1.42
F01111WX	Yellow	pk 10	£2.74
F01114WX	Blue	pk 10	£2.74
F01113WX	Green	pk 10	£2.74
F01112WX	Pink	pk 10	£2.74
F01115WX	Orange	pk 10	£2.74



A EziGlide Highlighters

- Premium hydrocarbon tip for smooth and clear marking on paper, copy and fax
- Ergonomically shaped barrel for comfort
- Vibrant fluorescent water based ink
- Line width 1 - 4.5mm for precise highlighting
- Assorted pack of 48 contains: 24 yellow, 6 green, 6 pink, 6 blue and 6 orange
- Assorted pack of 5 contains 1 each of blue, green, pink, orange and yellow



Code	Colour	Unit	
819159	Blue	pk 10	£3.96
819142	Green	pk 10	£3.96
819135	Orange	pk 10	£3.96
819128	Pink	pk 10	£3.96
819111	Yellow	pk 10	£3.96
819180	Assorted	pk 5	£2.19
EHC48	Assorted	pk 48	£12.11

ASSORTED COLOURS



B Edding 363 Chisel Tip Board Markers

- Chisel tip 1-5mm
- Lightfast, quick drying, low odour pigment ink
- Drywipe on most non-porous surfaces
- Cap-off ink prevents drying out when cap left off for a short period of time
- 8 assorted wallet (1 each of black, blue, red, green, orange, yellow, purple and brown)
- 50 pack (8 assorted colours, black, blue, red, green, orange, yellow, purple and brown)



SED363BK	Classpack Black	pk 50	£21.06
SED363ASS	Classpack 8 Asst	pk 50	£21.06
SED363AS8	8 Assorted	pk 8	£5.42

C Edding 360 Bullet Tip Board Markers

- Bullet tip 1.5-3mm
- Lightfast, quick drying, low odour pigment ink
- Drywipe on most non-porous surfaces
- Cap-off ink prevents drying out when cap left off for a short period of time
- 8 assorted wallet (1 each of black, blue, red, green, orange, yellow, purple and brown)
- 50 pack (8 assorted colours, black, blue, red, green, orange, yellow, purple and brown)



SED360BK	Classpack Black	pk 50	£21.06
SED360ASS	Classpack 8 Asst	pk 50	£21.06
SED360AS8	8 Assorted	pk 8	£5.42

A



A Berol Drywipe Markers

- Reliable drywipe markers, now at excellent prices!

Round Tip

DWMR8A	Assorted	pk 8	£6.16
DWMR12BK	Black	pk 12	£7.64
DWMR48	Classpack Asst	pk 48	£23.09
DWMR48BK	Classpack Black	pk 48	£23.09

Chisel Tip

DMMW8A	Assorted	pk 8	£6.16
DMMW48	Classpack Asst	pk 48	£23.09
DMMW48BK	Classpack Black	pk 48	£23.09

B



B Economy Drywipe Markers

- Low odour ink dries instantly
- Assorted 4:- 1 each black, blue, red & green
- Brand may vary

Chisel Tip

26035WX	Black	pk 10	£2.17
26036WX	Blue	pk 10	£2.17
26037WX	Red	pk 10	£2.17
26009WX	Green	pk 10	£2.17
26038WX	Assorted	pk 4	£1.13

Bullet Tip

98001WX	Black	pk 10	£2.19
98002WX	Blue	pk 10	£2.19
98003WX	Red	pk 10	£2.19
98004WX	Green	pk 10	£2.19
98005WX	Assorted	pk 4	£1.12
98001BP	Black	pk 100	£17.95

C



C Penflex Drywipe Markers

- Bullet tips
- Xylene free drywipe markers for all whiteboards
- Low odour ink dries instantly

Assorted Colours

DWTA4		pk 4	£2.14
DWTA6		pk 6	£2.65
DWTA10		pk 10	£4.18

Single Colours

DWTBK	Black	pk 10	£4.18
DWTBL	Blue	pk 10	£4.18
DWTRD	Red	pk 10	£4.18
DWTGR	Green	pk 10	£4.18

D



D Penflex Drywipe Marker Classpacks

- Xylene free markers for all whiteboards
- Low odour ink dries instantly
- Bullet tips

Standard Barrels

P50BB	Black	pk 50	£17.44
P50AB	Asst	pk 50	£17.44



Premium performance without the price tag!

A EziGlide Drywipe Markers

A revolutionary new drywipe marker that writes effortlessly and is easily erasable due to its high quality ink formula and fibre tip.

- EziGlide have been designed to last longer and provide a consistent flow of ink
- Available in classpacks of 48 in Bullet or Chisel Tip and Black or Assorted Colours

EG48BG	Green Bullet Tip	pk 48	£15.79
EG48BL	Blue Bullet Tip	pk 48	£15.79
EG48BR	Red Bullet Tip	pk 48	£15.79
EG48BB	Black Bullet Tip	pk 48	£15.79
EG48CL	Blue Chisel Tip	pk 48	£15.79
EG48BC	Black Chisel Tip	pk 48	£15.79
EG48AB	Asst Bullet Tip	pk 48	£15.79
EG48AC	Asst Chisel Tip	pk 48	£15.79



B Show-me Teacher Whiteboard Markers

- Full size premium drywipe markers
- Bullet tip with xylene-free, low odour ink
- Ventilated caps for safety
- 24 hour cap off time to prevent drying out

TWM10	Black	pk 10	£5.17
STM50	Black	pk 50	£23.47
STM4	Assorted	pk 4	£3.28

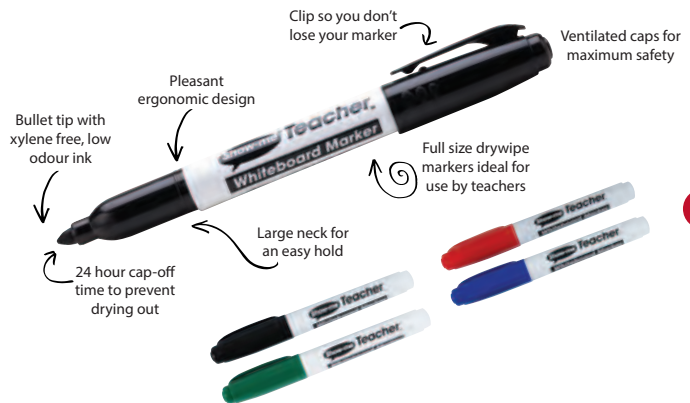

C Schneider 290 Maxx Flipchart/Drywipe Marker

- Unique flipchart marker that doubles up as a drywipe marker
- No more accidental whiteboard stains from using the wrong marker pen!
- Strong colours and quick drying ink for powerful flipchart presentations
- 2-3 day cap-off time for longer life
- Non squeak design, and odourless ink
- Toluene and Xylene free

SCHFBK	Black	pk 10	£9.92
SCHFASS	Assorted	pk 4	£3.74



D Bic Drywipe Markers

- Bullet and chisel tip
- Tough and long lasting

Bullet

F04692	Black	pk 12	£10.95
F03784	Blue	pk 12	£10.95
F06222	Red	pk 12	£10.95
F06218	Green	pk 12	£10.95
F03504	Assorted	pk 4	£4.57

Chisel

75109	Black	pk 12	£10.75
F01754	Assorted	pk 4	£4.29



CALL US ON 01527 878348

VISIT WWW.FORWARDPRODUCTS.CO.UK



A Ezigid Medium Tip Childrens Drywipe Pen

- Innovative new drywipe pens with a slim barrel and hardwearing medium tips
- Smart green barrels and lapel clips
- A great alternative to the leading brands, at a very low price point

EZIDWM	pk 10	£4.30
EZID30	pk 30	£12.91
EZID100	pk 100	£39.41
EZID200	pk 200	£75.93

NEW!

B



B Ezigid TriGrip Drywipe Pens

- Triangular shaped drywipe pens for easy grip
- Quick drying black ink
- Ideal for class whiteboard activities

EZDWTG35BK	pk 35	£12.50
------------	-------	--------

C



C Quickview Medium Tip Children's Drywipe Pens

- The original literacy & numeracy pen
- Ideal for small hands
- Has a slim barrel
- Medium sized, black bullet tip
- Broad stroke lines easily visible in class
- Free sample available

DWSL30	pk 30	£13.57
DWSL100	pk 100	£36.54
DWSL200	pk 200	£71.67
DWSL400	pk 400	£135.26

Premium performance without the price tag!



D



D Medium Tip Children's Drywipe Pen - Classtray

- All the advantages of the original literacy/ numeracy pen with the convenience of a storage tray / lid

CPDWSL100	tray 100	£41.25
-----------	----------	--------



E



E Berol Dry Wipe Pens

Slim barrel drywipe pen with low odour ink and tough nibs make these ideal for the rigours of academic use.

- Suitable for use on most leading brands of non-absorbent drywipe boards

Broad Point		
DW192BK	Broad	pk 192 £83.39



Show-me[®]



The Student's Favourite Whiteboard Pen

Designed specifically for schools • Easy-to-use with smaller hands • Perfect for mini whiteboards

Medium Tip

The bestselling all-rounder



Code	Description	Pack	Price
SMMB10	Medium Tip, Black	10	£4.38
SMMB100	Medium Tip, Black	100	£43.58
SMMB200	Medium Tip, Black	200	£88.97

Actual size

Assorted Colours

Get 10x more creative with 10 colours!



Code	Description	Pack	Price
SMMA10	Medium Tip, 10 Colours	10	£5.16
SMMA50	Medium Tip, 10 Colours	50	£23.28

Fine Tip

For when you need that extra detail



Code	Description	Pack	Price
SMFB10	Fine Tip, Black	10	£4.38
SMFB100	Fine Tip, Black	100	£43.58
SMFB200	Fine Tip, Black	200	£88.97



Code	Description	Pack	Price
SMFA10	Fine Tip, 10 Colours	10	£5.16
SMFA50	Fine Tip, 10 Colours	50	£23.28



CALL US ON 01527 878348



VISIT WWW.FORWARDPRODUCTS.CO.UK

NEW!

A



A Magnetic Whiteboard Organiser with Pens and Eraser

- Magnetic Whiteboard Organiser is suitable for use on all wall-mounted, magnetic whiteboards
- Store and tidy your whiteboard markers and eraser easily
- Includes four bullet tip drywipe markers in blue, black, green and red
- Also features a large, magnetic whiteboard eraser
- Ideal for use in classrooms and offices

MWBO	set	£8.64
------	-----	-------

B



B Mini Foam Erasers

- Ideal for small hands
- For use on handheld drywipe boards
- Approx size 75 x 50 x 25mm (3 x 2")
- Wipes away drywipe ink quickly and easily

DWMBE30	pk 30	£7.65
DWMBE100	pk 100	£23.10

C



C Show-me Mini Foam Erasers

- Ideal for small hands
- For use on handheld drywipe boards
- Approx size 75 x 50 x 25mm (3 x 2")
- Wipes away drywipe ink quickly and easily
- High density foam doesn't smear the ink or clog up

SMFE100	pk 100	£31.95
---------	--------	--------

D



D Large Whiteboard Erasers

- Washable drywipe eraser
- Lightweight eraser
- Soft absorbent surface makes board cleaning easy

F01972	each	£2.16
F01912	pk 12	£21.90

E



E Magnetic Board Erasers

- Large magnetic eraser
- Suitable for all sizes of dry wipe board

MBE	Board Erasers	each	£2.19
MBE24	Board Erasers	pk 24	£48.36



A Wooden Handled Board Erasers

- Traditional wooden handled erasers
- Soft, washable felt finish
- Use on whiteboards or chalkboards
- Choice of 2 sizes - small for students and large for teachers

LWHE	Large	pk 12	£17.62
SWHE	Small	pk 30	£15.99



A

B Magnetic Mini Board Erasers

- Effective felt cleaning surface
- Ideal for use with handheld whiteboards
- Compact size - easy for children to handle
- Easy grip handle in 5 assorted colours

MME20	Mini Board Erasers	bx 20	£14.00
-------	--------------------	-------	--------



B

C Whiteboard Cleaner

- For removing drywipe marker pen
- Removes grease and grime from all hard surfaces and whiteboards
- 250ml

F04552	Whiteboard Cleaner	each	£2.51
--------	--------------------	------	-------



C

D Whiteboard Permanent Ink Stain Remover

- A unique formula that rejuvenates the white board surface
- Conditions the board to leave like brand new
- Removes permanent ink, ghosting effects and minor scratches
- 150ml can

F01974	Stain Remover	each	£3.91
--------	---------------	------	-------



D

Never have dirty whiteboards again

Show-me® **MAGIX™**

Whiteboard Cleaner and Conditioner

Effortlessly restore a new look and feel to wall-mounted and mini whiteboards with this two-in-one product.

It's two products in one!

1. CLEANER

Makes all whiteboards like new. Each application effortlessly removes ghosting, stubborn staining, ballpoint pens and will even eradicate permanent marker.

2. CONDITIONER

Adds a conditioning microfilm layer to the board surface that not only improves the board's erasability, but gives a far smoother writing experience.

MAGIX™ comes in a trigger spray bottle for ease of use, and contains approximately 250 applications.

This means that for just a few pence per application, any whiteboard will look and feel brand new.



Code	Description	Pack	Price
WBC1	MAGIX 250ml (Trigger Spray Bottle)	1	£7.20



A Plain A4 Handheld Whiteboards

- Virtually indestructable drywipe boards
- Made from 650 micron gloss white PVC
- Tough but flexible - far more hardwearing than laminated card versions
- A4 size ideal for photocopying
- Safe, round corners

DWBPA430	Plain	pk 30	£39.99
DWBPA4100	Plain	pk 100	£99.94



A

B Lined A4 Handheld Whiteboards

- Printed light lines at 20mm intervals
- Encourages neat handwriting & straight lines
- Plain reverse side for standard board activities

DWBLA430	Lined	pk 30	£52.88
DWBLA4100	Lined	pk 100	£117.52



B

C Gridded A4 Handheld Whiteboards

- A light grid pattern forming 20mm squares
- Assists children to form numbers and characters within the squares
- Ideal for graphs, charts, shapes & flow diagrams
- Plain reverse side for standard board activities

DWBGA430	Gridded	pk 30	£51.34
DWBGA4100	Gridded	pk 100	£117.52



C

D Plain DL Sized Whiteboards

- Plain white flashcards, approximate size 210 x 99mm (1/3 A4)
- Ideal for displaying individual words
- Suitable for both pupils and teachers

DWBMDL30	pk 30	£18.55
DWBMDL100	pk 100	£48.95

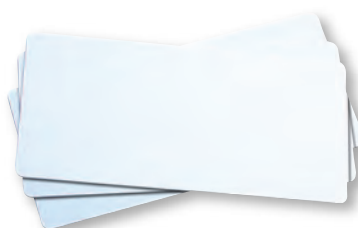

D



CALL US ON 01527 878348

VISIT WWW.FORWARDPRODUCTS.CO.UK

Show-me®



The original and best selling Show-me® Boards

Show-me Boards are more than mini whiteboards – they are fun, versatile and reusable classroom resources with no restrictions on how, where, when or why they can be used.

Just like the whiteboard on the classroom wall, Show-me Boards can also be used for workings, note-taking, mind maps and more. Every student in the class can have one for individual work, and teachers can see a whole class of answers by simply asking for the boards to be held in the air. Visual assessment has never been easier, and there's no need to waste pen and paper.

Better yet, on a Show-me Board, there's no pressure to get things right on the first try. Who wouldn't be more confident with the ability to erase and start again?

Embrace the freedom of mini whiteboards in your class

- ✓ Quickfire assessments from the front of the class
- ✓ No haunting mistakes
- ✓ Save wasting paper

**ALL-IN-ONE
302 Piece Bulk
Box (100 sets)**



**ALL-IN-ONE 107
Piece Classpack
(35 sets)**

**FREE 100ml
Bottle of MAGIX
Whiteboard
Cleaner and
Conditioner**

**FREE A5
Teachers'
Resources
Booklet**



35 Mini Foam Erasers

35 Show-me Boards

35 Black Medium Tip Drywipe Pens

Engagement from all ages

Anti-glare coating

Virtually indestructible recyclable plastic



Plain Whiteboards

Write, draw, calculate, record and mind map anything and everything.

Use these classic, lightweight A4 whiteboards to increase the interactivity of teaching and learning across the curriculum for all ages. Use each board time and time again, with the double-sided ultra-smooth finish for top-quality erasability. A timeless classroom essential.

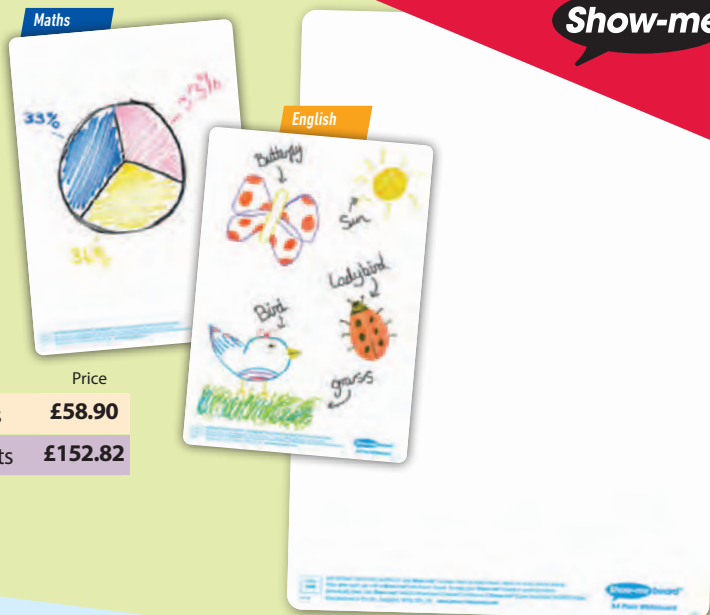

Code	Description	Pack	Price
SMPL35	Plain Boards, Classpack	35 Sets	£58.90
SMPL100	Plain Boards, Bulk Box	100 Sets	£152.82

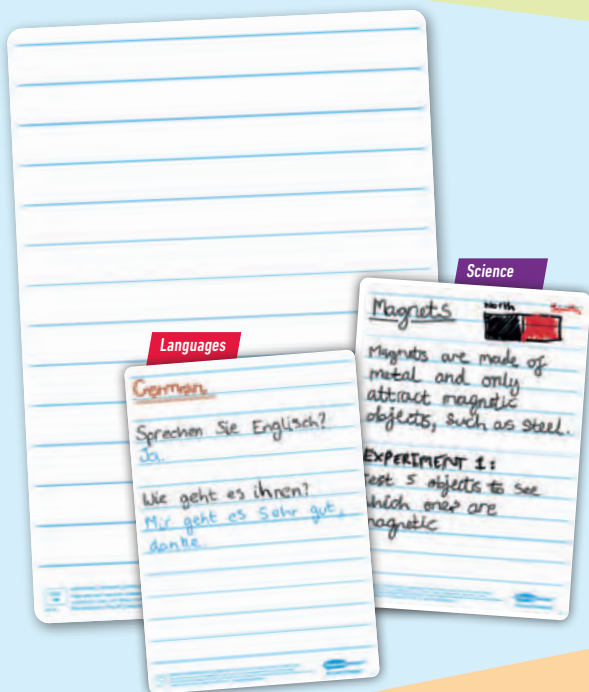

Lined Whiteboards

Write it right.

Better than exercise books for improving handwriting and presentation. Great for encouraging students to experiment and improve without the worry of permanent marks in their books. Double sided, ultra-smooth finish with ruled lines at 20mm intervals, with a plain reverse.

Code	Description	Pack	Price
SMPLI35	Lined Boards, Classpack	35 Sets	£68.47
SMPLI100	Lined Boards, Bulk Box	100 Sets	£178.62

Gridded Whiteboards

Think inside the box.

A maths essential for all ages, with a 20mm grid which is ideal for learning times tables, laying out calculations and creating graphs without wasting paper. Ultra-smooth finish with a plain reverse.

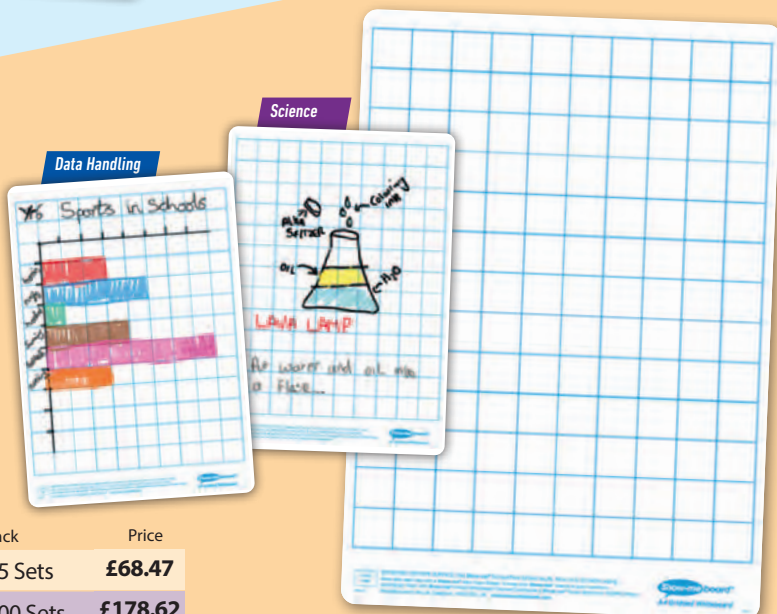

Code	Description	Pack	Price
SMGR35	Gridded Boards, Classpack	35 Sets	£68.47
SMGR100	Gridded Boards, Bulk Box	100 Sets	£178.62





Double the Space, Double the Creativity

All the benefits of a standard Show-me Board but with twice the space. These extra-large and extra-thick whiteboards are available in Lined and Gridded with a plain reverse, and are brilliant for group work, teacher demos, and larger pieces of work.

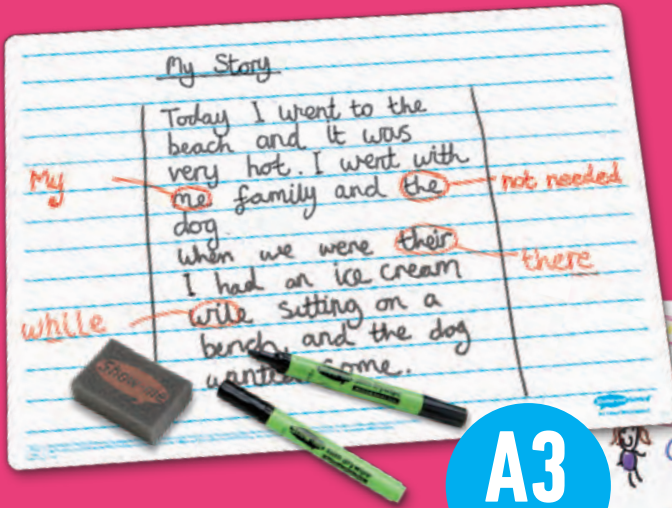

**A3
SIZE**

A3 Lined/Plain

With even more space for story telling and writing practice, these A3 lined boards can be used across the curriculum to get writing right. And, with a plain reverse, students can draw a large picture to accompany any stories or short pieces of writing.

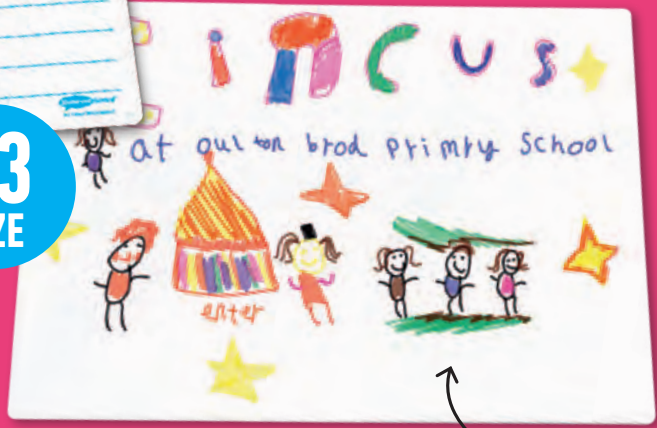

Teachers love...
Getting students to write in the middle of the board, leaving space on either side for comments from the teacher or other students.

Plain Reverse

Code	Description	Pack	Price
SMPLIA3	A3 lined Boards	5 Pk	£24.59

A3 Gridded/Plain

With so much space, students can visualise statistics in a whole host of ways on an A3 gridded board. Bar graphs, scatter graphs and pie charts will all fit side by side on the 20mm squares and can make for great discussion when comparing data.

Code	Description	Pack	Price
SMGRA3	A3 Gridded Boards	5 Pk	£24.59

This 16-Piece Pack contains:

- 5 x A3 Gridded Whiteboards
- 5 x Black Medium Tip Drywipe Pens
- 5 x Mini Foam Erasers
- A Teachers' Resources Booklet



**A3
SIZE**





These A4 Handwriting Whiteboards have been designed to assist teachers in helping students form letters in the correct proportions. Lines are arranged in groups of 4 with 3 x 6mm spaces between them - ideal for splitting letters up into tops, tails and middles.

A4 Handwriting Whiteboards

Each board also features:

- The alphabet printed along the top in both uppercase and lowercase
- Vowels highlighted in bold
- A blank reverse for a wide variety of other Show-me Board activities

Code	Description	Pack	Price
SHBA4	Handwriting Boards, Classpack	35 Sets	£70.85

ALL-IN-ONE 107-PIECE CLASSPACK CONTAINS:

- 35 x A4 Whiteboards
- 35 x Black Drywipe Markers
- 35 x Mini Foam Erasers
- A **FREE** 100ml Bottle of MAGIX Whiteboard Cleaner & Conditioner
- A Teachers' Resources Booklet



A4 Phoneme Whiteboards

These high-quality A4 Phoneme Whiteboards are perfect for Early Years and Key Stage 1 daily phonic sessions, particularly ahead of Year 1 phonics screening checks. The ideal resource for teachers looking for a way to make learning phonics easy.

Each board also features:

- A 6 section phoneme frame
- Ruled handwriting lines underneath
- A blank reverse for a wide variety of other Show-me Board activities

Code	Description	Pack	Price
SMPH35	Phoneme 6 Panel Boards, Classpack	35 Sets	£68.47
SMBHBP	Classpack	pk 302	£180.37

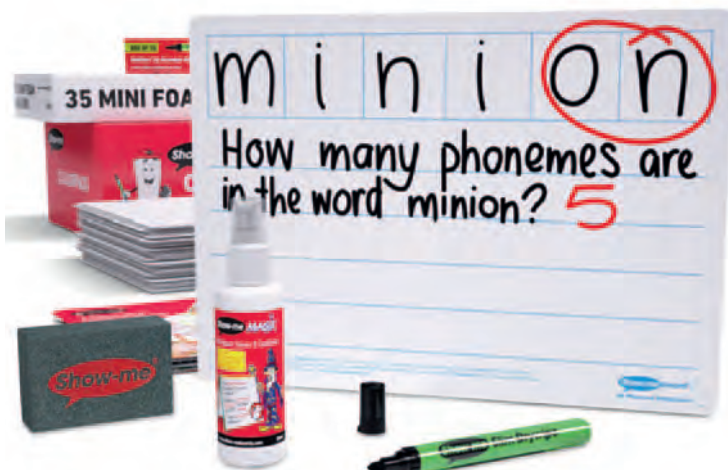

CALL US ON 01527 878348



VISIT WWW.FORWARDPRODUCTS.CO.UK



A4 Clockface Whiteboards

Ideal for all classroom telling-the-time activities, these Show-me Clockface Whiteboards are ideal for early Primary School age students when learning to tell the time. Both the traditional and digital clocks include space for individual minutes.

Each board...

- Features a traditional clockface as well as a digital read out block to familiarise young minds with different ways of telling the time
- Is double-sided with a plain reverse for standard Show-me Board activities
- Benefits from all the high-quality features of a genuine Show-me Board



Code	Description	Pack	Price
SMCF35	Clockface Boards, Classpack	35 Sets	£67.24



ALL-IN-ONE 107-PIECE CLASSPACK CONTAINS:

- 35 x A4 Whiteboards
- 35 x Black Drywipe Markers
- 35 x Mini Foam Erasers
- A **FREE** 100ml Bottle of MAGIX Whiteboard Cleaner & Conditioner
- A Teachers' Resources Booklet

A4 Music Whiteboards

Show-me Music Composition Whiteboards not only feature evenly spaced lines in groups of 5 for the composition of bass and treble (or treble only) music, but also feature reference points for common types of notes and treble clef practice too.

Each board has...

- Been designed by music teachers for a harmonious music lesson
- Been pre-printed with common notes, such as semibreves, minims, quavers and more
- Space for student's name - ideal for photocopying work to refer back to later

Code	Description	Pack	Price
MRBC	Music Boards, Classpack	35 Sets	£70.85
MRBBU	Music Boards, Classpack	100 Sets	£178.62



Compose your best lessons using these Music Composition Whiteboards



The original and best selling Show-me® Boards now available in 5 tint colours

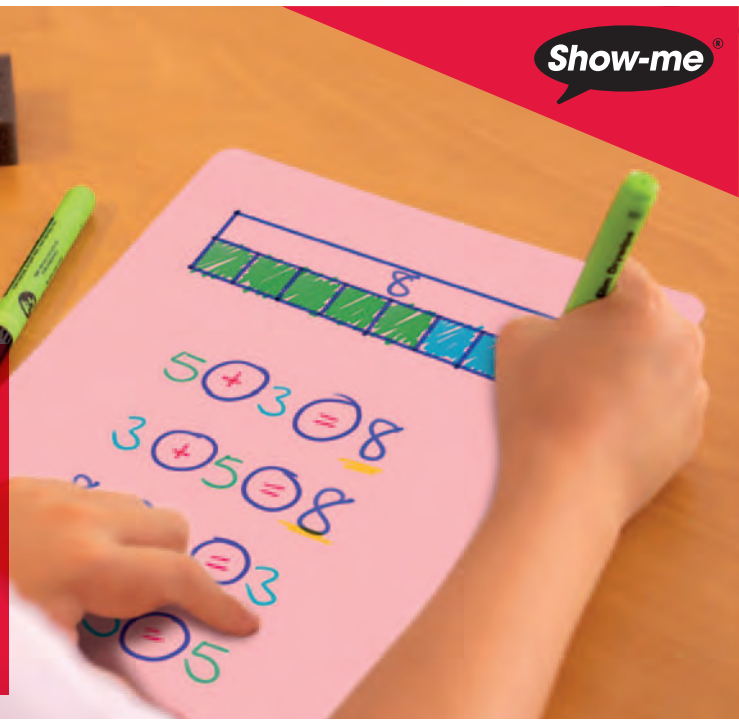

Perfect for students with visual stress symptoms

Anti-glare coating

Virtually indestructible recyclable plastic

Give the freedom of mini whiteboards to everyone in your class.

- ✓ Quickfire assessments from the front of the class
- ✓ No haunting mistakes
- ✓ Save wasting paper



Individual Packs of 5 Tinted Boards

Code	Description	Pack	Price
SMGRTINT	A4 Plain Green Tinted Boards	5 Pk	£14.05
SMYWTINT	A4 Plain Yellow Tinted Boards	5 Pk	£14.05
SMBLTINT	A4 Plain Blue Tinted Boards	5 Pk	£14.05
SMCRTINT	A4 Plain Cream Tinted Boards	5 Pk	£14.05
SMPKTINT	A4 Plain Pink Tinted Boards	5 Pk	£14.05

Packs of Boards only. Pens and accessories available separately.



ALL-IN-ONE 107 Piece Classpack

Code	Description	Pack	Price
SMCPTINT	A4 Plain Assorted Tinted Boards, Classpack	35 Sets	£99.50

Don't forget to add:

SMMB100	Slim, Medium Tip Drywipe pens, Black	100 Pk	£43.58
SMFE100	Mini Foam Erasers	100 Pk	£31.95
WBC1	250ml MAGIX Bottle (cleans over 200 mini boards)	1 Pk	£7.20

The student's favourite drywipe pens
Classbox of 100 Medium Tip Pens



Designed with small hands and busy classrooms in mind
Mini Foam Erasers - Classbox of 100



Brings your whiteboards back to life again
Removes permanent marker!



CALL US ON 01527 878348



VISIT WWW.FORWARDPRODUCTS.CO.UK

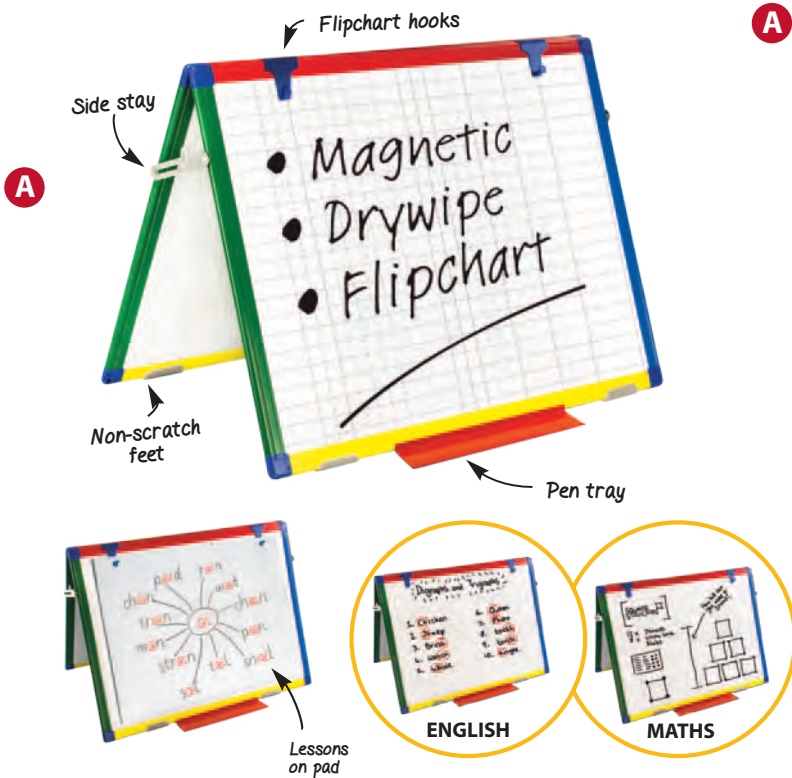

A A2 Desktop Magnetic Easel

Make group activities easier with a magnetic desktop easel; use it as a divider for 2 teams, or for whole classrooms to work from, you could even take it outside.

- Strong robust design - use for many years
- Large A2 (600 x 450mm) double-sided magnetic drywipe surface with 20mm gridlines on one side
- Fold away design for easy storage after use
- Pen tray and flipchart hooks included
- Flipchart pads sold separately - turn your A2 desktop easel into a flipchart, which can be used in the classroom or at staff meetings

DTEAS	Double-sided Easel	each	£77.52
FPA240	A2 Pads (40 sheets)	pk 5	£21.48



B Colour-coded Magnetic Letter Set

Use this 'sorting system' to save valuable lesson time for teaching instead.

- Contains 286 colour-coded magnetic lowercase letters in a rigid plastic storage case with lid
- All consonants are blue and vowels red, as used in many teaching systems
- The solid plastic tray is separated into labelled compartments for ease of storage
- The letters are ideal for use with all magnetic boards and are an essential tool in helping children to build word and sentence skills
- Each letter is 25–38mm tall

SCCML	Colour Coded Letters set	£29.84
-------	--------------------------	--------

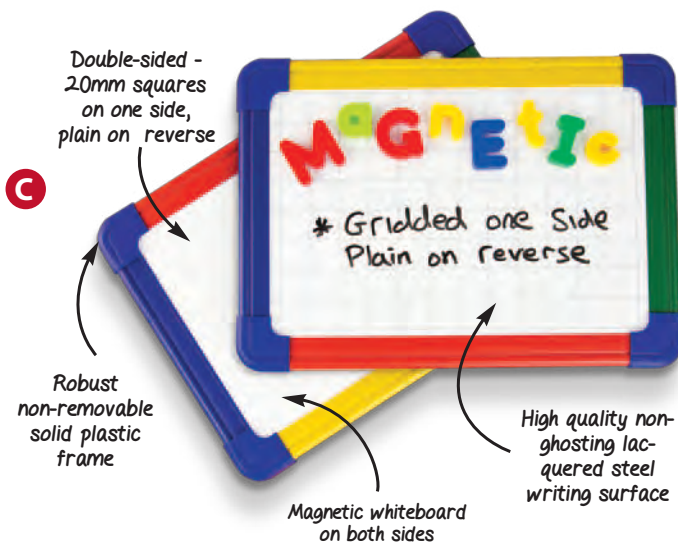

C Magnetic Framed Boards

Always fun to use, Showme® magnetic products have been popular ever since the 'Letters & Sounds' phonics programme was launched as part of the Primary National Strategy.

- Plain one side, gridded reverse (magnetic both side)
- A4 and A3 are ideal for portable use or away from the desk

SMGBA4	A4 Gridded/ Plain	pk 10	£44.37
SMGBA3	A3 Gridded/ Plain	pk 5	£44.48



STORAGE TRUNK INCLUDED

A

A Magnetic Group Pack

610 Piece Group Pack

These highly adaptable magnetic packs contain all of the resources you'll need to get students engaged, both inside and outside the classroom. The pack shown above contains:

- 10 x A4 Framed Whiteboards
- 1 x A3 Framed Whiteboard
- 12 x Black Medium Tip Drywipe Pens
- 12 x Magnetic Mini Erasers
- 1 x Tub of 286 Numbers & Maths Symbols
- 1 x Tub of 286 Magnetic Lowercase Letters

All of this is supplied in a FREE storage trunk, perfect for keeping the classroom tidy.



SMGBGP	610 Piece Magnetic Pack	£107.17
--------	-------------------------	---------

- And if you only want to order extra tubs of letters only

MP288	Lower Case Letters tub 286	£16.76
-------	----------------------------	--------

B A4 Rigid Boards

Why Rigid boards?

Fully rigid board made of solid MDF core with premium glossy drywipe surface on both sides. Excellent erasability. Does not bend or flex, and can be used when there is no desk surface available, making the board more versatile for use away from the desk.

These rigid boards can be used for 'Carpet Time', out in the playground, on field trips, wherever, whenever.

- Plain both sides

RWBA4P10	A4 Plain Gridded	pk 10	£16.83
RWBA4P30	A4 Plain Gridded	pk 30	£65.95

- 3 lines on one side, plain on the reverse

RWBA4L10	A4 Lined Gridded	pk 10	£17.59
RWBA4L30	A4 Lined Gridded	pk 30	£52.76

- 20mm gridlines, plain on the reverse

RWBA4G10	A4 Rigid Gridded	pk 10	£17.59
RWBA4G30	A4 Rigid Gridded	pk 30	£52.76



B



NEW!



A Clear Pencil Cases

- Clear PVC zip pencil cases
- Assorted colour zips
- 2 sizes available

DFPCSM	203 x 117mm	pk 12	£7.92
DFPCLG	330 x 127mm	pk 12	£9.99



B Helix Pencil Cases

- Clear PVC zip pencil cases ideal for use in exams
- Assorted coloured zips
- 2 sizes available

M77040	200 x 125mm	pk 12	£9.86
M78040	330 x 125mm	pk 12	£11.69

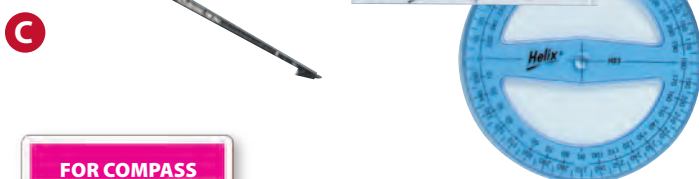

C Helix Maths Instruments

Compasses

- Self centring compass with safety point

G05048	Metal	pk 25	£9.96
--------	-------	-------	-------

Protractors

H0304050	100mm 360°	pk 50	£16.12
H0104050	100mm 180°	pk 50	£7.16

FOR COMPASS PENCILS
SEE PAGE 72

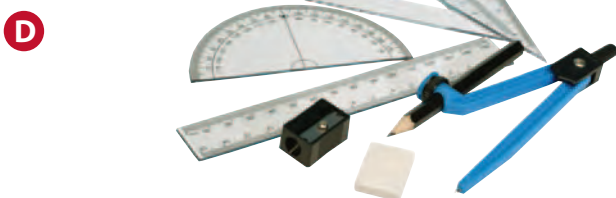

D Helix Value Maths Sets

- Excellent value maths set contains 15cm rule, 45° and 60° set squares, 180° protractor, plastic compass, 9cm pencil, sharpener and eraser

A54000	Value Maths Set	each	£1.55
--------	-----------------	------	-------



E Helix Geometry Classpack

- Handy storage tray contains 30 each of angle measurers, 30cm shatter resistant rulers, metal safety compass, 3½" pencils, 45° and 60° set squares

Q99040	Geometry	each	£52.21
--------	----------	------	--------

A Clear Metric Only Rulers

- Shatter resistant
- Measurements in centimetres and millimetres
- Ideal for precise measurements
- Bevelled edge

50111	30cm/300mm	pk 100	£14.04
-------	------------	--------	--------



A



B Clear Acrylic Rulers

- Measurements in millimetres centimetres, and inches
- Bevelled edge

F01106	15cm/6"	each	£0.19
F01107	30cm/12"	each	£0.25



B

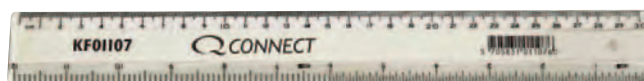

C Shatter Resistant Rulers

- Measurements in millimetres, centimetres and inches
- Ideal for everyday classroom use
- Bevelled edge

F01108	Clear 30cm/12"	each	£0.23
F01109	White 30cm/12"	each	£0.32



C

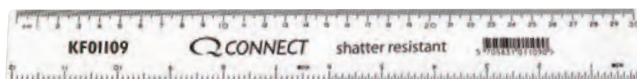

D White Rulers

- Measurements in centimetres and inches
- Solid white colour
- Bevelled edge

K09050	30cm/12"	pk 100	£16.67
--------	----------	--------	--------



D

E Coloured Rulers

- Assorted colours
- Measurements in centimetres and inches
- Shatter resistant
- Ideal for everyday classroom and office use

A09050	30cm/12"	pk 100	£18.46
--------	----------	--------	--------



E



A



A Texet SL8

Ideal for classrooms, this calculator has simple and easy to use functions including memory and auto power off.

- 8 digit display
- Dual powered
- Square root & percentage key
- Biomaster antibacterial protection
- Classpack of 30 calculators comes in a Gratnells tray with a foam stacking insert and a protective lid

TXSL8	Texet SL8	each	£1.79
TXSL8CP	Classpack	pk 30	£62.95

B



B Textet SL200

- A KS 1 calculator with an 8 digit display
- Dual power & auto power off
- Large, easy-to-use plastic keys and colourful casing
- Full function memory
- Percentage key

TXSL200	Textet SL200	each	£4.72
---------	--------------	------	-------

C



C Textet Albert 2

- Fraction scientific calculator with 10 digit display + 2 exponent, back space correction function
- 10 +2 digit display
- Dual powered
- Full function memory
- Auto power off
- Antibacterial protection
- Colours may vary

TXAL2	Albert 2	each	£4.40
TXAL2CP	Classpack	pk 30	£140.38

D

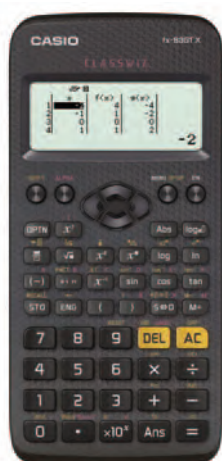

D Casio FX83GTX Scientific

- Allowed in every UK exam where a calculator can be used
- Suitable from key stage 3, 4 and above and recommended for GCSE and A/AS level, standard and higher
- 260 functions
- Battery powered with large 10 + 2 display
- Shows Roots & fractions as they appear in textbooks

CAFX83		each	£10.88
--------	--	------	--------



A Heavy Duty Zip Wallets

- Heavy duty polythene wallets in 4 sizes

A5 (255 x 180mm)

ZWA5BL	A5 Blue	pk 25	£9.46
ZWA5RD	A5 Red	pk 25	£9.46
ZWA5GR	A5 Green	pk 25	£9.46
ZWA5YW	A5 Yellow	pk 25	£9.46
ZWA5AS	A5 Assorted	pk 100	£37.32

A4 (320 x 230mm)

ZWA4BL	A4 Blue	pk 25	£9.74
ZWA4RD	A4 Red	pk 25	£9.74
ZWA4GR	A4 Green	pk 25	£9.74
ZWA4YW	A4 Yellow	pk 25	£9.74
ZWA4AS	A4 Assorted	pk 100	£38.62

Oversize A4 (370 x 255mm)

ZWFCBL	A4+ Blue	pk 25	£10.51
ZWFCRD	A4+ Red	pk 25	£10.51
ZWFCGR	A4+ Green	pk 25	£10.51
ZWFCYW	A4+ Yellow	pk 25	£10.51
ZWFCAS	A4+ Assorted	pk 100	£41.97

A3 (485 x 340mm)

ZWA3BL	A3 Blue	pk 25	£13.93
ZWA3AS*	A3 Assorted	pk 100	£57.73

* While stocks last



A

B Reinforced Zipper Bags

- Clear PVC bags reinforced with white mesh and a sturdy zip
- Mixed colour zips: red, blue, green, yellow and black in each pack

MZA4	A4	pk 5	£6.02
MZPC	Pencil Case		
	125 x 325mm	pk 5	£5.11
MZ1252	Pencil Case		
	125 x 200mm	pk 5	£4.68

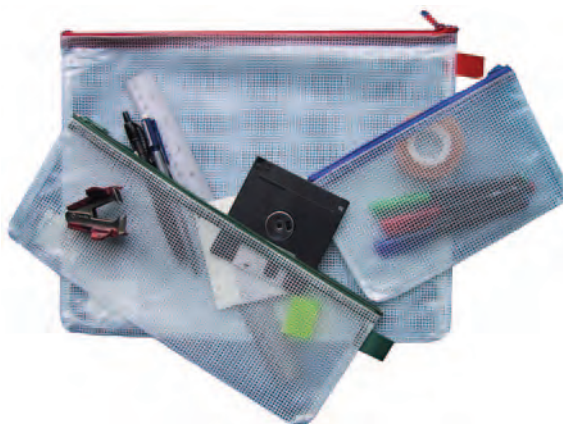

B

C Gripseal Bags

- Re-sealable bags with a simple, efficient, interlocking seal

Write-on Bags

F01311	90 x 115mm	pk 1000	£12.17
F01380	150 x 230mm	pk 1000	£35.52
F01403K	230 x 325mm	pk 1000	£58.93



C

NEW!

A Elba Laminated Ring Binders

- These bright, stylish ring binders feature high quality laminated paper over durable board for a high gloss, metallic finish
- Perfect for implementing a colour coordinated system
- This A4+ binder has a 2 O-ring mechanism with a 25mm capacity

ELBRBBK	Black	pk 10	£11.76
ELBRBBL	Blue	pk 10	£11.76
ELBRBDG	Dark Green	pk 10	£11.76
ELBRBLB	Light Blue	pk 10	£11.76
ELBRBLG	Light Green	pk 10	£11.76
ELBRBOR	Orange	pk 10	£11.76
ELBRBPK	Pink	pk 10	£11.76
ELBRBPU	Purple	pk 10	£11.76
ELBRBRD	Red	pk 10	£11.76
ELBRBSI	Silver	pk 10	£11.76
ELBRBYW	Yellow	pk 10	£11.76

NEW!**B**

B Durafle A4 Ring Binders

- Durable construction
- Assorted colours may vary

DFRA4AS	Assorted	pk10	£11.99
---------	----------	------	--------

**C**

C Polyprop A4 Ring Binders

- Wipe clean polypropylene covers
- Vibrant colours with a 25mm capacity

Economy (brand may vary)

RBBK	Black	pk 10	£8.73
RBBBL	Blue	pk 10	£8.73
RBRE	Red	pk 10	£8.73

Standard Quality

F01472	Yellow	pk 10	£10.87
F01474	Purple	pk 10	£10.87
F02003	Blue	pk 10	£9.89
F02004	Green	pk 10	£9.89
F02005	Black	pk 10	£9.89
F02008	Red	pk 10	£9.89

LOWEST PRICE**D**

D Paper Over Board A4 Ring Binders

- Label on spine for easy identification
- Strong, 2 ring mechanism with 25mm capacity

20034	Black	pk 10	£11.85
20035	Blue	pk 10	£11.85
20036	Red	pk 10	£11.85
20037	Green	pk 10	£11.85
F01473	Yellow	pk 10	£11.85
F01475	Purple	pk 10	£11.85

**E**

E Translucent Frosted A4 Ringbinders

- Hard-wearing, wipe clean polypropylene, 2 ring A4 ring binders
- 25mm rings (1½") spine

F02482	Red	each	£2.20
F02483	Blue	each	£2.20
F02484	Green	each	£2.20
F02486	Purple	each	£2.20
F02487	Clear	each	£2.20
F02488	Assorted	pk 12	£20.61



A Elba Laminated Lever Arch Files

- These bright, stylish files feature a standard lever arch mechanism with a 70mm capacity
- Made from high quality laminated paper over durable board for a high gloss finish
- Perfect for implementing a colour coordinated system, these A4 files have a large spine label and thumb hole

ELBLABK	Black	pk 10	£21.91
ELBLABL	Blue	pk 10	£21.91
ELBLADG	Dark Green	pk 10	£21.91
ELBLALB	Light Blue	pk 10	£21.91
ELBLALG	Light Green	pk 10	£21.91
ELBLAOR	Orange	pk 10	£21.91
ELBLAPK	Pink	pk 10	£21.91
ELBLAPU	Purple	pk 10	£21.91
ELBLARD	Red	pk 10	£21.91
ELBLASI	Silver	pk 10	£21.91
ELBLAYW	Yellow	pk 10	£21.91



B Durafile A4 Lever Arch Files

- Durable construction
- Assorted colours may vary

DFLA4AS	Assorted	pk10	£21.99
---------	----------	------	--------



C Polypropylene A4 Lever Arch Files

- Smart, durable coloured lever arch files
- Finger pull for easy retrieval
- Large label on spine for quick identification

20019	Black	each	£2.42
20020	Blue	each	£2.42
20021	Red	each	£2.42
20022	Green	each	£2.42
20023	Yellow	each	£2.42
20024	White	each	£2.42



D Paper On Board A4 Lever Arch Files

- Large label area and thumb hole on spine for easy identification and retrieval
- Locking slots, metal runners and a quality mechanism help keep documents secure

20038	Black	pk 10	£17.35
20039	Blue	pk 10	£17.35
20040	Green	pk 10	£17.35
20041R	Red	pk 10	£17.35
F01470	Yellow	pk 10	£17.35



E Standard Lever Arch Files

- Mottled cover durable board lever arch file
- Large label areas for quick identification
- Finger pull helps retrieve your files easily

20001WX	A4 Economy	pk 10	£12.96
A4LAST	A4 Standard	pk 10	£16.13
FCLAST	Foolsap Standard	pk 10	£18.49



LOWEST PRICE

NEW!**A**

A Pukka Pad® Brights Range Box Files Laminated

- Assorted Colours
- These quality box files provide secure and dust-free storage for all your important documents
- Fitted with internal spring lock to hold your documents in place

BFBRAS	Assorted	pk 10	£24.99
--------	----------	-------	--------

B

B Traditional Box Files

- Large spine label for easy identification
- Foolscap size

Mottled Grey

E20012	Economy	pk 10	£23.94
P20012	Premium	pk 10	£33.95

Coloured

20016	Red	each	£3.92
20017	Black	each	£3.92
20018	Blue	each	£3.92
20015	Green	each	£3.92
F01469	Yellow	each	£3.92

C

C Polypropylene Box File

- Made from strong polypropylene, the file will withstand constant use and last for years
- Accepts foolscap papers & document wallets
- Internal spring holding mechanism
- Curved front enables easy access

F04102	Black	each	£6.17
F04103	Blue	each	£6.17
F04104	Red	each	£6.17

D

D Spine Labels

Self adhesive spine labels for clear identification of files.

- 60 x 189mm
- Compatible with most lever arch files

F02217	Spine Labels	pk 10	£2.85
--------	--------------	-------	-------



A Clear Punched Pockets

- Clear multi punched pockets to fit all binders
- PPA4EC are 40 micron, PPA4ST are 55 micron and PPA4HD are 65 micron
- PPA4HD has glass clear finish

PPA4EC	A4 Economy	pk 100	£1.38
PPA4ST	A4 Standard	pk 100	£2.35
PPA4HD	A4 Heavy Duty	pk 100	£5.80
PPA3L	A3 Landscape	pk 10	£8.33

Oversized - take over 30 sheets of paper

PPA425Z		pk 25	£2.65
---------	--	-------	-------



B A4 Expanding Punched Pockets

- 13mm capacity holds up to 250 sheets
- Reinforced and multi-punched to allow for filing in ring binders and lever arch files
- High quality durable plastic material

PPA4EX		pk 5	£4.71
--------	--	------	-------



C A4 Cut Flush Folders

- Clear Folders open top and side with thumb cut for easy access

Clear

ECFC	Economy	pk 100	£4.30
SCFC	Standard	pk 100	£6.23

Coloured

CFCOLRD	Red	pk 100	£7.98
CFCOLBL	Blue	pk 100	£7.98
CFCOLGR	Green	pk 100	£7.98
CFCOLYW	Yellow	pk 100	£7.98



D Binding Rings

- Ideal for holding punched pockets together
- 19mm diameter

F02216		pk 100	£11.87
--------	--	--------	--------



E Ring Reinforcements

- Adhesive rings manufactured from paper or extra strong vinyl
- Permanent adhesive

50002		pk 1000	£4.05
-------	--	---------	-------



CALL US ON 01527 878348



VISIT WWW.FORWARDPRODUCTS.CO.UK

A



A Presentation Ring Binders

- Premium quality A4 presentation binders
- Clear pockets on front, back and spine for all round presentation
- 4 ring mechanism

F01326	25mm Red	pk 10	£16.49
F01327	25mm Blue	pk 10	£16.49
F01328	25mm Black	pk 10	£16.49
F01325WX	25mm White	pk 10	£16.49

F01330	40mm Red	pk 10	£26.42
F01331	40mm Blue	pk 10	£26.42
F01332	40mm Black	pk 10	£26.42
F01329WX	40mm White	pk 10	£26.42

F01334WX	65mm White	pk 10	£35.92
----------	------------	-------	--------

B



B Black Presentation Display Books

- Create a stylish personalized presentation
- Quality A4 display books featuring a front cover pocket for further personalization of display or presentation
- Complete with copy-safe clear pockets

F01263	10 Pockets	each	£2.24
F01265	20 Pockets	each	£2.98
F01267	40 Pockets	each	£3.97

C



C Rigid Cover Display Books

- Quality A4 leather look hard back
- Ideal for professional presentation or projects and course work
- Available in black

RDBK24BK	24 Pockets	each	£6.60
----------	------------	------	-------



A Flexible Display Books

- Flexible polyprop covers with removable spine label
- A4 size
- Ideal for project work

F01252	20 Pocket Black	each	£1.68
F01251	20 Pocket Blue	each	£1.68
F01250	20 Pocket Red	each	£1.68
F01260	40 Pocket Black	each	£2.94
F01259	40 Pocket Blue	each	£2.94
F01258	40 Pocket Red	each	£2.94



A

B Snopake Clear Display Books

- Add style and flair to any presentation
- Made from 100% copysafe polypropylene
- Transparent covers for own cover design

F02777	A5 20 Pocket	each	£4.12
F01927	A4 20 Pocket	each	£7.74



B

C Quickclip Display Files

A quality presentation folder, ideal for storing and presenting unpunched documents.

- Simple to use, just pull out the clip, insert your papers and push the clip in
- Manufactured from PVC with a transparent cover and coloured back
- A4 size in 2 capacities, 3mm will hold up to 30 sheets and 6mm will hold up to 60 sheets of paper

3mm Capacity

F00459	Black	pk 25	£12.66
F00462	Blue	pk 25	£12.66
F00461	Red	pk 25	£12.66

6mm Capacity

F00465	Black	pk 25	£18.67
F00468	Blue	pk 25	£18.67



C



CALL US ON 01527 878348



VISIT WWW.FORWARDPRODUCTS.CO.UK

A

**5 YEAR
WARRANTY**

A Snopake ClampBinders

Combining good looks with practicality.

- Ingenious clamp mechanism holds up to 100 sheets of 80gsm unpunched paper
- Strong polypropylene covers for long life
- Reversible spine label for personalisation
- Business card and loose paper holder inside front cover
- A4
- Assorted Electra™ colours are: blue, turquoise, purple, green and pink

F03115	Clear	pk 10	£41.82
F02813	Assorted	pk 10	£41.82

B



B Rapesco Pivot Clip Files

- Durable A4 "superline" polypropylene file with a pivoting clip to secure contents
- Front page visible through cover
- 3mm/30 sheet (80gsm) capacity

40339	Pivot Clip Files	pk 5	£11.95
-------	------------------	------	--------

C



C Register Files

- A4 PVC covered file ideal for keeping SIMS paperwork clean and flat.
- Contains corner pocket to inside cover, 4 heavy-duty pockets, clip and pen holder on inside back cover
- Label holder on front cover for identification

REGFBK	Black	each	£10.65
REGFBL	Blue	each	£10.65
REGFGN	Green	each	£10.65
REGFRD	Red	each	£10.65
REGFYW	Yellow	each	£10.65



A Polyprop Document Wallets

- Polypropylene snap wallets
- Extra durable filing in bright colours
- Stud fastening on flap to secure loose papers

F01240Q	Red	A4	pk 12	£8.37
F01241Q	Yellow	A4	pk 12	£8.37
F01242Q	Blue	A4	pk 12	£8.37
F01243Q	Green	A4	pk 12	£8.37
F01244Q	Clear	A4	pk 12	£8.37
F03598Q	Purple	A4	pk 12	£8.37
F03599Q	Assorted	A4	pk 12	£8.37
F02470	Clear	A5	pk 12	£8.24
F03609	Assorted	A5	pk 12	£8.24



A

B Report Files

- Lightweight A4 folders with clear covers
- Full length label
- 2 hole flat bar filing clip

RFA4BK	Black	pk 25	£4.17
RFA4BL	Blue	pk 25	£4.17
RFA4RD	Red	pk 25	£4.17
RFA4GR	Green	pk 25	£4.17
RFA4YW	Yellow	pk 25	£4.17
RFA4PU	Purple	pk 25	£4.17
RFA4OR	Orange	pk 25	£4.17
RFA4AS	Assorted	pk 25	£4.17



B

C Elasticated Box Files

- Elasticated closure for security
- 25mm capacity

F02307	Blue	each	£3.61
F02310	Clear	each	£3.19



C



CALL US ON 01527 878348



VISIT WWW.FORWARDPRODUCTS.CO.UK

A



A Transfer Spring Files

- 300gsm manilla files with compressor bar to hold documents in place
- Spring mechanism for fast insertion and extraction of papers
- Suitable for both A4 and foolscap papers

26061	Blue	pk 25	£13.91
26062	Buff	pk 25	£13.91
26057	Yellow	pk 25	£13.91
26060	Green	pk 25	£13.91
26059	Orange	pk 25	£13.91
26058	Pink	pk 25	£13.91

B



B Square Cut Folders

- Folders fit neatly into suspension files
- Asst (20 each blue, buff, green, yellow & red)

SQFBF	Buff	pk 100	£5.71
SQFLWBL	Blue	pk 100	£7.76
SQFLWGN	Green	pk 100	£7.76
SQFLWYW	Yellow	pk 100	£7.76
SQFLWRD	Red	pk 100	£7.76
SQFLWPK	Pink	pk 100	£7.76
SQFLWOR	Orange	pk 100	£7.76
SQFLWAS	Assorted	pk 100	£9.25

C



C Premium Square Cut Folders

- Heavy duty 300 micron board
- Capacity to hold up to 100 sheets of A4 paper

4825	Blue	pk 50	£27.24
4823	Green	pk 50	£27.24
4828	Red	pk 50	£27.24
4820	Assorted	pk 50	£27.24

D



D Kraft Tabbed Folders

- Tabbed folders in quality recycled Kraft manilla
- Tabbed in 5 positions

F01578		pk 100	£9.64
--------	--	--------	-------



A Document Wallets

- Colourful folders with expanding gussets for large volumes of A4 or foolscap papers

Economy 250gsm (brand may vary)

			1-9	10+
DOCWBL	Blue	pk 50	£5.89	£5.12
DOCWBU	Buff	pk 50	£5.89	£5.12
DOCWGR	Green	pk 50	£5.89	£5.12
DOCWPI	Pink	pk 50	£5.89	£5.12
DOCWYW	Yellow	pk 50	£5.89	£5.12

Standard 285gsm

23010	Buff	pk 50	£7.91
23011	Blue	pk 50	£7.91
23012	Green	pk 50	£7.91
23013	Grey	pk 50	£7.91
23014	Orange	pk 50	£7.91
23015	Pink	pk 50	£7.91
23016	Red	pk 50	£7.91
23017	Yellow	pk 50	£7.91
F01490	Assorted	pk 50	£9.45



B Heavy Duty Document Wallets

- 300 micron pressboard for durability
- Expands to hold up to 180 sheets of foolscap or A4 paper
- Assorted pack contains red, green, yellow, blue and lilac

4790	Assorted	pk 25	£17.59
------	----------	-------	--------



C Recycled Document Wallets

- Manufactured from heavyweight 250gsm 100% recycled kraft manilla

26090	Recycled Wallets	pk 50	£10.07
-------	------------------	-------	--------



D Premium Document Wallets

- Strong 300 micron board
- Expand to hold up to 320 sheets
- 100% recycled!

22881	Blue	pk 25	£15.13
22882	Pink	pk 25	£15.13
22884	Yellow	pk 25	£15.13
22886	Green	pk 25	£15.13
22883	Purple	pk 25	£15.13
22880	Assorted	pk 25	£15.13



A

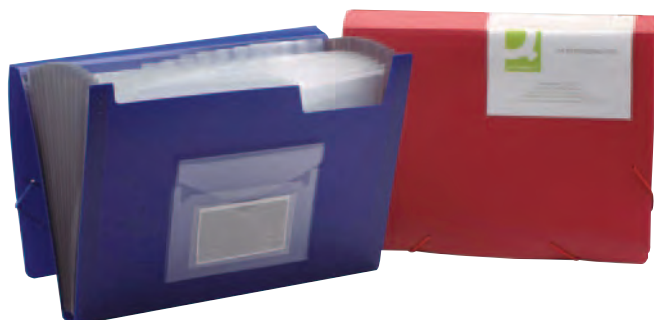

A Polyprop Expanding Files

- 13 part expanding files
- Made from hardwearing polypropylene
- Features two pockets beneath the front flap for storage
- Suitable for A4 papers

F01274	Red	each	£4.79
F01275	Blue	each	£4.79

B



B Manilla Expanding Files

- Range of expanding files to keep paperwork organised
- Made from strong manilla
- Reinforced gussets
- Suitable for A4 or foolscap papers
- Available in:
 - A-Z (19 pockets)
 - 1-31 (31 pockets)

22001	A-Z	each	£5.69
F04090	1-31	each	£7.77

C

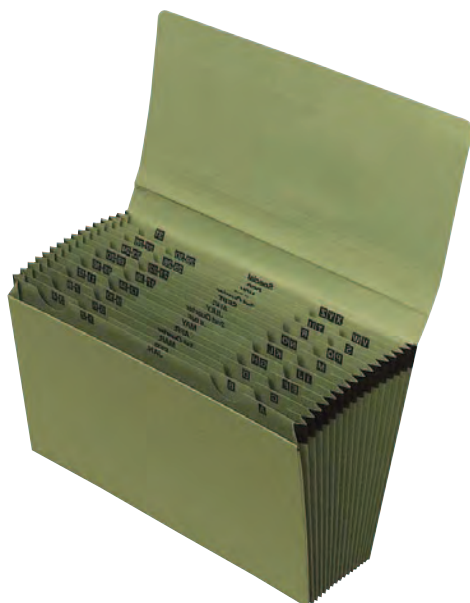

C Green Expanding File

- 16 pocket expanding file manufactured from strong manilla
- Gussets are indexed A-Z, 1-31, months and quarters, and coated in clear Mylar reinforcement
- Suitable for A4 or foolscap papers

F04093		each	£7.53
--------	--	------	-------



A Suspension Files & Accessories

- Foolscap files with crimped metal bar
- Supplied complete with tabs and inserts
- Replacement tabs and inserts available

21001WX	Economy Files	pk 50	£12.09
21001	Standard Files	pk 50	£13.27
21002	Replacement Tabs	pk 50	£2.99
21003	Replacement Inserts	pk 50	£2.57



A

B Crystalfile Standard Capacity Suspension Files

- Foolscap files with colour coated runners for colour coded filing
- Contrasting interior to prevent filing errors
- Files punched to accept Twinlock filing clip for filing punched papers
- Complete with Crystalfile tabs and inserts
- Holds up to 150 sheets of paper
- V base

78046	Green Files	pk 50	£65.62
78141	Red Files	pk 50	£68.77
78143	Blue Files	pk 50	£68.77

78020	Replacement Tabs	pk 50	£27.26
78050	Replacement Inserts	pk 50	£2.77



B

C Crystalfile 30mm Capacity Suspension Files

- Foolscap 30mm capacity suspension file for storage of bulky files, can hold up to 300 sheets of A4 80gsm paper
- Reinforced base for strength and durability
- Steel runners to support heavy loads
- Contrasting interior to prevent filing errors
- Complete with tabs and inserts

78041	Green Files	pk 50	£91.99
70622	Red Files	pk 50	£105.55
70625	Blue Files	pk 50	£105.55

78020	Replacement Tabs	pk 50	£27.26
78050	Replacement Inserts	pk 50	£2.77



C



A Subject Dividers

- A4 subject dividers, multi-punched to suit most types of binders
- Individually shrink-wrapped to ensure dividers are kept in good condition
- Ideal for students and office use

DIV5	5 Tab Coloured	set	£0.24
DIV10	10 Tab Coloured	set	£0.31
DIV12	12 Tab Coloured	set	£1.55
DIV15	15 Tab Coloured	set	£2.13
DIV20	20 Tab Coloured	set	£2.82
DIVAZM	A-Z Manilla	set	£2.33



B Extra Wide Dividers

- Extra wide subject dividers, ideal for use with punched pockets
- Multi-punched to suit most types of binders

DIVEW5	5 Tab	set	£0.59
DIVEW10	10 Tab	set	£1.00
DIVEWAZ	A-Z	set	£4.51

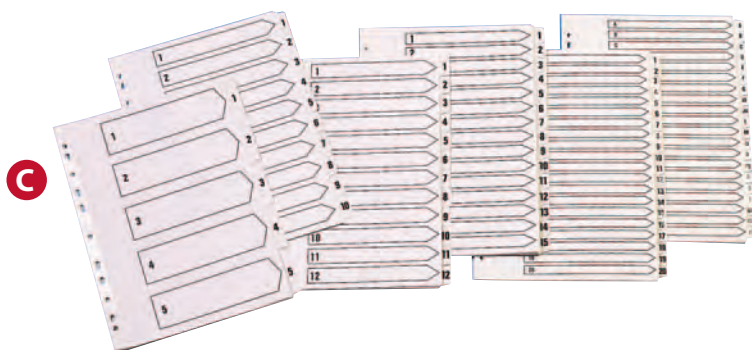

C White Board Tabbed Indexes

- Ideal for numerical or alphabetical filing
- Clear Mylar reinforced tabs and punched holes for durability
- Contents page for cross reference
- A4 multi-punched

F01528	1-10	each	£1.20
F01532	A-Z 20 Part	each	£2.22



D White Board Multi-Colour Tabbed Indexes

- Tabbed indexes are multi-coloured with a matching contents page
- Manufactured from white board with mylar reinforced tabs
- A4 multipunched

F01518	1-5	set	£0.45
F01519	1-10	set	£0.66
F01520	1-15	set	£1.28
F01521	1-20	set	£1.24
F01522	1-31	set	£2.11
F01523	A-Z	set	£1.18
F01524	Jan-Dec	set	£1.21
F01525	5 Part	set	£0.83
F01526	10 Part	set	£1.02



A Card Index Box

- Traditionally styled boxes
- Easy to store business cards and important information
- Durable plastic
- Hinged lid
- Cards sold separately



A

6 X 4"

10010	Black	each	£3.51
-------	-------	------	-------

8 X 5"

10020S	Black	each	£4.84
--------	-------	------	-------

B Index Record Cards

- Suitable for use in our card index boxes
- Ideal for contact details
- Feint ruled on both sides



B

35204	5 x 3"	pk 100	£1.17
35205	6 x 4"	pk 100	£1.23
35206	8 x 5"	pk 100	£2.71

C Index Guide Cards

- Suitable for use in our card index boxes
- Strong manilla cards
- Tabbed A-Z In 25 positions



C

35208	6 x 4"	set	£2.52
-------	--------	-----	-------

D Fluorescent Dividers

- Eye catching fluorescent dividers
- Five stunning neons: Pink, Orange, Green, Red & Yellow
- Punched 4 holes



D

89099	5 Part	set	£0.99
89199	10 Part	set	£1.99

E Heavy Duty Dividers

- Brightly coloured extra thick A4 dividers for durability
- Quality heavyweight 290gsm board



E

52599	5 Part	set	£1.69
52699	10 Part	set	£3.00



CALL US ON 01527 878348



VISIT WWW.FORWARDPRODUCTS.CO.UK

A



A Corner Filing Unit

- A professional filing unit designed for efficient organisation and storage
- Manufactured from 15mm beech melamine faced MDF (flat packed)
- With rounded and polished edges & with linking bolts for various configurations
- Supplied complete with MDF separators
- Lockable castors for easy movement
- H840 x C710 x D440mm

FBCORN	each	£175.69
--------	------	---------



The Mobile Large Storage Unit can be combined with the Quarter Round Unit Curve In & Out to create an exciting room divider or reading area

B



Curve Out



B Quarter Round Units

- Choose from Curve-In or Curve-Out unit
- Manufactured from 15mm Beech melamine faced MDF with rounded, polished corners and lockable castors
- Robust, classically designed units provide efficient and generous storage solutions.
- Size (assembled): H700 x C1175 x D310mm (flat packed)

FBQRCI	Curve In	each	£187.94
FBQRCO	Curve Out	each	£187.94

C



C Mobile Large Storage Unit – Beech

- Manufactured from 15mm Beech melamine faced MDF with rounded, polished corners and lockable castors
- Robust, classically designed units provide efficient and generous storage solutions
- Size (assembled): H700 x W1000 x D310mm (flat packed)

FBLSU	each	£125.65
-------	------	---------



A Colour Filing Boxes

- Brightly coloured filing boxes for A4 and foolscap documents
- Made from tough corrugated fibreboard
- Size: H355 x W85 x D280mm
- Pack of 11 assorted colours (flat packed)

CFBXAS pk 11 £17.99



A

B Library Boxes

- Suitable for A4 documents
- Made from tough corrugated fibreboard
- Size: H300 x W100 x D245mm
- Pack of 10 (flat packed)

LBBL	Blue	pk 10	£23.39
LBGN	Green	pk 10	£23.39
LBRD	Red	pk 10	£23.39
LBYW	Yellow	pk 10	£23.39



B

C Book Browser Boxes

- Holds books and magazines up to 200mm wide and 200mm deep
- Made from tough corrugated fibreboard
- Size: H150 x W210 x D240mm (flat packed)
- 3 each Red, Blue, Green and Yellow

SCHBB pk 12 £20.38



C

D Document Wallet Store

- Store foolscap document wallets
- Made from tough corrugated fibreboard
- Size (assembled): H250 x W370 x D170mm
- Pack of 4, Red (flat packed)

DCWLT pk 4 £19.13



D

E A4 Multistore

- A4 filing and book organizer
- Made from tough corrugated fibreboard
- 6 compartments each W75 x D240mm
- Size (assembled): H300 x W480 x D245mm
- Pack of 4, Blue (flat packed)

A4MST A4 Multistore pk 4 £33.24



E

A



A Wall Pocket

- Heavy duty A4 polypropylene pockets
- Robust, easily wiped clean and can be hung anywhere
- Available with either 2 or 4 pockets
- 2 pocket size: H320 x W500 x D50mm
- 4 pocket size: H690 x W500 x D50mm
- Pocket depth 40mm width 220mm
- Blue

2FPBL	2 Pocket	each	£25.44
4FPBL	4 Pocket	each	£38.86

B



B Six Compartment Wall Pocket

- Heavy duty A4 polypropylene pockets
- Robust, easily wiped clean and can be hung anywhere
- 6 overlapping pockets
- Size: H915 x W300 x D115mm
- Pocket depth 30mm width 230mm
- Red or blue

6MFPBL	Blue	each	£54.94
6MFPBD	Red	each	£54.94

C



C Register Book Wall Pocket

- Heavy duty polypropylene, hanging register holder, can be easily wiped clean
- Size: H395 x W330 x D50mm
- Pocket depth: 50mm, width 275mm
- Red or green

REGPRD	Red	each	£18.24
REGPGN	Green	each	£18.24

D



D Literature Sorters

- Ideal for desktop storage
- Holds A4 or Foolscap papers and documents in 10 pigeon holes
- Each pigeon hole: H65 x W275 x D330mm
- Can be stacked up to 4 tiers high and is flat packed for easy storage
- Tough corrugated fibreboard
- Assembled size: H385 x W585 x D330mm

LITSORT	pk 4	£48.58
---------	------	--------

D + E



E



E Literature Sorter Drawers

- Turn a literature sorter into a useful drawer unit with a set of drawers
- Perfect for filing paperwork, class work, or art and craft materials
- Holds A4 size papers or documents
- Supplied in a mixed pack of 5 (1 each red, yellow, green, blue & orange)
- Made from heavy duty corrugated board and supplied flat packed for quick and easy assembly
- Assembled size: H60 x W270 x D320mm

DRWSORT	pk 5	£12.95
---------	------	--------



A Ring Binder Filing Modules

- A stacking module designed for storing ring binders, it is also ideal for magazines etc. and even loose papers in the 48mm wide pigeon holes
- 10 compartments for storing ring binders or files
- Tough corrugated board
- Stack up to 4 tiers high with no need for shelves or cabinets
- Assembled size: H385 x W585 x D295mm

RBMOD pk 5 £68.25



A

B Lever Arch Filing Modules

- Stores six A4/Foolsap lever arch files and can be stacked up to 4 tiers high
- Easy to assemble, tough corrugated oyster fibre-board protects files & permits quick retrieval
- No need for shelves or cabinets.
- Assembled size: H385 x W585 x D295mm

LAMOD pk 5 £62.57



B

C Tidy Store Modules

- Each module is designed to hold the A4 Tidy Stores to create a unique filing system that caters for project work and many other filing needs
- Each box can be quickly stacked and removed without disturbing any others
- Can also be used to file books, magazines, files or drawing papers, both vertical or horizontal and stacked on top of each other to provide maximum storage in a limited space
- Heavy duty corrugated board
- Supplied flat packed, quick and easy to assemble

A4TSM pk 4 £35.92



C

D Tidy Store Boxes

- Ideal storage for many items used in the classroom or office
- Made from strong corrugated fibreboard with a hinged lid these boxes are easy to use and stack
- Designed to provide an economic solution to a range of storage problems
- Can be used alone, or stored within the A4 tidy module
- Supplied flat packed for efficient storage. Simple to assemble
- Size: H50 x W315 x D240mm
- Assorted contains 3 each of red, yellow, green and blue

A4TSMX A4 Assorted pk 12 £15.83



C + D



D



CALL US ON 01527 878348



VISIT WWW.FORWARDPRODUCTS.CO.UK

A



A Archive Storage Boxes

- Durable low cost storage boxes
- Easy to assemble with lift off lid
- W335 x D400 x H250mm
- Choose either heavy duty, twin wall or standard, single wall
- Both hold 3 transfer files

21660	Twin Wall White	pk 10	£29.16
21665	Single Wall Brown	pk 10	£21.07

B



B Mega-Store Archive Box

- Heavy Duty twin walled box with capacity to hold 3 Transfer Files or 4 Magazine Files
- W383 x D430 x H295mm

21738	Mega-Store	pk 10	£40.28
-------	------------	-------	--------

C



C Magazine Files

- Organize your catalogues and books
- Choose heavy duty (W100 x D230 x H300mm) or standard (W73 x D246 x H329mm)

21659	Heavy Duty White	pk 10	£11.98
21667	Standard, Brown	pk 20	£17.43

D



D Transfer Files

- Flip-top lid
- Large label area
- Choose from Heavy Duty Twin wall (W98 x D367 x H239mm) or standard (W92 x D317 x H241mm)

21661	Twin Wall, White	pk 10	£14.69
21666	Single Wall, Brown	pk 20	£20.87



A Desk Top Sorter

- 8 shelf unit manufactured from corrugated board
- Plastic shelf edges add extra strength and longevity
- Ideal for office, postroom or classroom

F01039	Desk Top Sorter	each	£20.55
--------	-----------------	------	--------



A

B Lever Arch Storage Module

- A convenient way to store your lever arch files
- Each module holds up to 6 Foolscap lever arch files
- Internal dimensions: H360 x W525 x D280mm

LASM	Storage Module	each	£17.78
------	----------------	------	--------



B

C Heavy Duty Literature Organiser

- Range of Pigeonhole units in 2 different sizes ideal for sorting paper and card
- Melamine laminated board carcass for long life with corrugated board divider system
- Easy to construct, flat pack design

HDL024	24 Compartments	each	£131.65
HDL036	36 Compartments	each	£175.83



C



CALL US ON 01527 878348



VISIT WWW.FORWARDPRODUCTS.CO.UK

A



A Flat Back Literature Holders

- Clear styling for maximum visibility
- Fit to any flat vertical surface
- Shallow profile adds to the sleek flat-back design
- Ideal for school literature

76091	1/3 A4	each	£4.94
76391	A5	each	£6.35
76491	A4	each	£7.07

B



B Unbreakable Wall File Pockets

- Manufactured from unbreakable polycarbonate, ideal for heavy duty use.
- Pockets nest together saving even more space
- Takes A4 documents

63201	Wall File Pockets	each	£9.12
-------	-------------------	------	-------

C



C A4 Sign Holders

- These clear sign holders are slanted for easy reading.
- Stands back 10 degrees making it ideal for important messages
- Loads from the side
- Perfect for menus, instruction and events

47401	A4 Sign Holders	each	£4.84
-------	-----------------	------	-------

D



D Ballot/Suggestion Box

- Free standing or wall mountable White Suggestion Box
- Features built-in 110mm wide literature pocket
- For counter or wall mount use - includes mounting hardware
- Also includes lock and 2 keys
- W349 x D92 x H330mm

79803	Ballot/Suggestion	each	£50.92
-------	-------------------	------	--------



A Clear Leaflet Dispensers

- This useful range of leaflet dispensers allows you to display the full front cover of each item
- A4, A5 and 1/3A4 literature is accommodated
- Generous 47mm deep pockets accommodates plenty of literature
- Wall fixings included
- Optional partition hangers fit all sizes

Wall Mounted

CLD12A4	12 x A4	each	£260.38
CLD1312	12 x 1/3 A4 + 6 x A4	each	£255.05
CLD2413A4	24 x 1/3 A4	each	£247.37
CLD9A4	9 x A4	each	£211.44
CLD613A4	6 x 1/3 A4 + 6 x A4	each	£200.86
CLD6A4	6 x A4	each	£269.97
CLD613	6 x 1/3 A4 + 3 x A4	each	£184.06
CLD1213A4	12 x 1/3 A4	each	£165.31
CLD12A5	12 x A5	each	£196.83

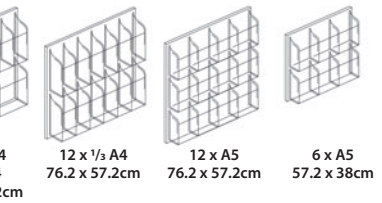
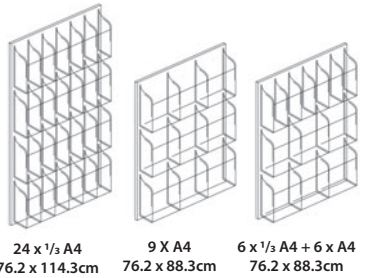
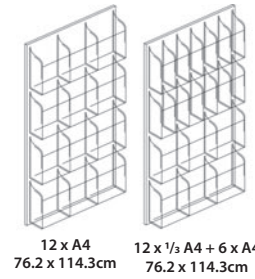

A

B Panorama Leaflet Dispensers

All units are the same height and can therefore be mounted side by side for continuous displays of different size leaflets.

- Available in 6 sizes
- Moulded plastic units with clear acrylic fronts
- Available in a choice of 10 colours
- Freestanding dispensers are double sided

Panorama Wall Mounted Dispensers

PLD1000**	A4 3 Pockets	A	each	£48.31
PLD1001**	A4 6 Pockets	B	each	£61.33
PLD1002**	A5 4 Pockets	C	each	£40.30
PLD1006**	A5 8 Pockets	D	each	£56.61
PLD1003**	1/3 A4 4 Pockets	E	each	£44.57
PLD1007**	1/3 A4 8 Pockets	F	each	£54.53

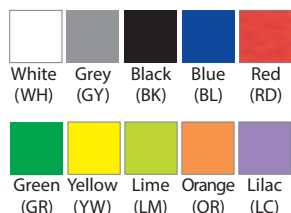

B

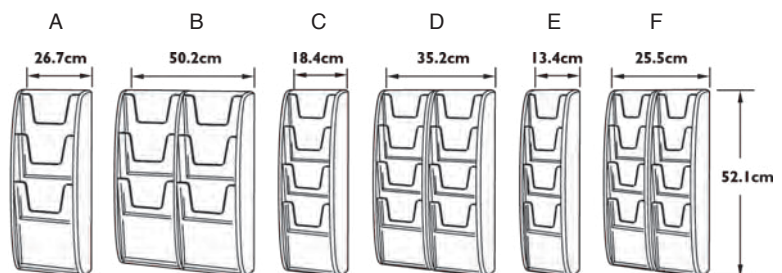

3 Litre Box

9 Litre Box

18 Litre Box

35 Litre Box

42 Litre Box

64 Litre Box

84 Litre Box



3 Litre Box



4 Litre Box



9 Litre Box



50 Litre Box



12 Litre Box



48 Litre Box



18 Litre Box
Multimedia Box



84 Litre Box

Really Useful Boxes

- Ideal for all office media and files
- Transparency for ease of content identification
- Positively stack for rigidity and safety
- Provides sturdy protection from the elements and vermin

3 Litre Box W245 x D180 x H160mm

- Will hold 18 CD's or 10 DVD's

4 Litre Box W395 x D255 x H80mm

- Will hold one ream of A4 paper

9 Litre Box W395 x D255 x H155mm

- Will hold 40 CD's or 20 DVD's or A4 paper

12 Litre Box W465 x D270 x H150mm

- Will hold C4 envelopes

18 Litre Multimedia Box W480 x D390 x H200mm

- Will hold 93 Cd's or 44 DVD's

35 Litre Eurobox W480 x D390 x H310mm

- Can hold foolscap or A4 suspension files. Also ideal as a personal organiser

42 Litre Box W520 x D520 x H310mm

- Generous foolscap capacity ideal for transportation

48 Litre Box W600 x D400 x H310mm

50 Litre Box W710 x D440 x H230mm

64 Litre Box W710 x D440 x H310mm

- Large foolscap capacity for cost effective storage

84 Litre Box W710 x D440 x H380

- Extra large capacity for cost effective storage

80177	3 Litre Box	each	£4.91
80044	4 Litre Box	each	£6.92
80173	9 Litre Box	each	£8.07
80501	12 Litre Box	each	£9.86
80155	18 Litre Box	each	£12.45
80130	35 Litre Box	each	£17.59
80117	42 Litre Box	each	£17.83
80147	48 Litre Box	each	£21.72
80051	50 Litre Box	each	£19.49
80007	64 Litre Box	each	£22.82
80080	84 Litre Box	each	£29.19



Gratnells Storage Trays

Colour Chart



- Red *RE
- Blue *BL
- Yellow *YE
- Green *GR
- Cyan *CY
- Pink *PK
- Purple *PU
- Pale Blue *PB
- Tangerine *TA
- Lime *LI
- Blueberry Jelly *BJ
- Strawberry Jelly *SJ
- Kiwi Jelly *KJ
- Grape Jelly *GJ
- Lemon Jelly *LJ
- Clear *CL
- White *WH
- Light Grey *LG
- Charcoal Shallow & Deep Only *CH
- Black *BK

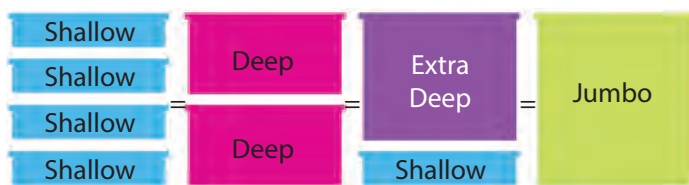

Shallow Trays

- Size: W312 x D427 x H75mm

Standard Colours

STRAYRE	Red	£2.59
STRAYBL	Blue	£2.59
STRAYGR	Green	£2.59
STRAYPU	Purple	£2.59

Special Colours

STRAY*		£2.99
--------	--	-------

* Please specify colour from colour chart



Deep Trays

- Size: W312 x D427 x H150mm

Standard Colours

DTRAYRE	Red	£3.84
DTRAYBL	Blue	£3.84
DTRAYGR	Green	£3.84
DTRAYPU	Purple	£3.84

Special Colours

DTRAY*		£4.39
--------	--	-------

* Please specify colour from colour chart



Extra Deep Trays

- Size: W312 x D427 x H225mm

Standard Colours

EDTRAYRE	Red	£4.90
EDTRAYBL	Blue	£4.90
EDTRAYGR	Green	£4.90
EDTRAYPU	Purple	£4.90

Special Colours

EDTRAY*		£5.65
---------	--	-------

* Please specify colour from colour chart



Jumbo Trays

- Size: W312 x D427 x H300mm

Standard Colours

JTRAYRE	Red	£6.03
JTRAYBL	Blue	£6.03
JTRAYGR	Green	£6.03
JTRAYPU	Purple	£6.03

Special Colours

JTRAY*		£6.65
--------	--	-------

* Please specify colour from colour chart

Clear Lids

TLID	Transparent Tray Lid	£2.05
------	----------------------	-------



CALL US ON 01527 878348



VISIT WWW.FORWARDPRODUCTS.CO.UK

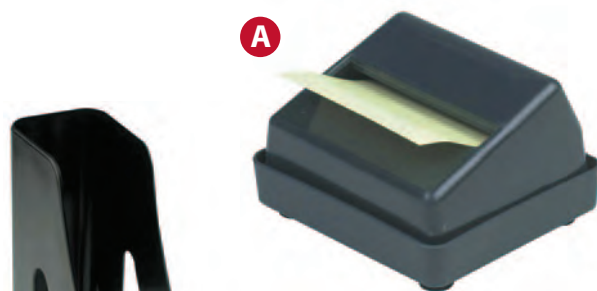

A Executive Sticky Note Dispenser

- Constructed from high quality impact resistant black plastic
- Uses 75 x 75mm sticky notes
- Non slip, anti-scratch feet

21672	Dispenser	each	£7.26
F02161	Sticky Notes	pk 12	£6.63



B Executive Magazine Rack

- Constructed from high quality impact resistant black plastic
- Ideal for storing magazines, catalogues etc.

21708	Black	each	£5.54
-------	-------	------	-------



C Executive Letter Tray & Risers

- Constructed from high quality impact resistant black plastic
- Generous capacity for foolscap or A4 documents
- The trays use clip on risers which improve the appearance of the tray when not stacked

F05555	Letter Trays	each	£3.63
F05565	Risers	pk 4	£2.05



D Executive Book Rack

- Constructed from high quality impact resistant black plastic
- Adjustable dividers for different widths
- Additional racks can be added to the interlocking base

21692	Book Rack	each	£21.46
-------	-----------	------	--------



E Executive Pen Tidy

- Constructed from high quality impact resistant black plastic
- 2 tall compartments which accept pens and 2 shallow compartments for paper clips, pins, erasers etc.

21704	Pen Tidy	each	£2.61
-------	----------	------	-------



A Fashion Letter Tray

- Moulded in highly robust material
- Will hold documents up to 24 x 32cm in size
- 100% recyclable & stackable
- Size: W257 x D348 x H66mm

F00002C	White	each	£6.05
F00032C	Purple	each	£6.05
F00031C	Pink	each	£6.05
F00030C	Green	each	£6.05
F00033C	Blue	each	£6.05

Vibrant Fashion Colours



A

B Fashion Magazine Files

- Finger grip and low sill to facilitate easy insertion and retrieval of documents
- Holds all documents up to 24 x 32cm in size
- 8cm width capacity
- 100% recyclable
- Size: W82 x D265 x H310mm

74002C	White	each	£8.71
74032C	Purple	each	£8.71
74033C	Blue	each	£8.71



B

C Desk Tidies

- Space efficient, compact and elegant
- Enables you to assemble and arrange all your office accessories
- Includes anti-skid rubber feet
- Shock-resistant polystyrene glossy effect finish
- Size: W143 x D158 x H93mm

10022	White	each	£13.61
10329	Purple	each	£13.61
10333	Blue	each	£13.61



C

D Fashion Waste Bins

- Stylish waste bin with handles & contrasting matt and gloss effect
- Cone shaped with a curved rim for ease of waste disposal
- 100% recyclable & 14 litre capacity
- Size: W305 x D290 x H334mm

80002C	White	each	£7.62
80032C	Purple	each	£7.62
80033C	Blue	each	£7.62



D

E Drawers

- Unique and elegant style desktop module
- Generously sized drawers accepting documents up to 24 x 32cm in size
- Holds up to 450 A4 sheets (80gsm) per drawer
- Anti-skid pads provided
- Robust impact polystyrene, 100% recyclable
- Size: W292 x D386 x H246mm

10618	Purple	each	£43.33
10166	Green	each	£43.33
10167	Blue	each	£43.33



E



A Letter Trays

- Accepts both A4 and foolscap papers
- Steel risers available to create extra capacity
- Clearance height of 123mm
- Manufactured from high impact polystyrene

10050	Black	each	£2.16
10052	Blue	each	£2.16
10055	Red	each	£2.16
10059	Risers	pk 4	£1.19



B Magazine Racks

- Accepts A4 and foolscap documents
- Ideal for storing magazines, catalogues, price lists etc. neatly
- Unique capacity for two standard ringbinders

F04061	Black	each	£2.74
F04062	Blue	each	£2.74
F04064	Red	each	£2.74



C Pen Pots

- Attractive and durable 6 tube desk tidy
- Ideal for keeping pens, pencils, paperclips etc. in one neat place

10040	Black	each	£2.12
10041	Blue	each	£2.12
10042	Red	each	£2.12



D Memo Boxes

- Complete with anti-slip feet and a pen rest
- Comes with 750 sheets of 90 x 90mm white paper
- Refill blocks available

21676	Black	each	£4.53
F01119	Refill Block	each	£2.73



E Waste Bins

- Large 15 litre capacity plastic bins

F01124	Black	each	£3.16
F01127	Blue	each	£3.16
F01128	Red	each	£3.16



A Plus Range Letter Trays

- A unique range of three sizes of letter trays - slim, standard and jumbo to fit your needs.
- All sizes can be stacked together without risers
- Black
- Dimensions: W255 x D360 x H37mm (slim)
- W255 x D360 x H70mm (standard)
- W255 x D360 x H103mm (jumbo)

74861	Slim	each	£3.55
11095	Standard	each	£4.84
70917	Jumbo	each	£8.40

Slim
Standard
Jumbo



B Mesh Magazine Files

- Holds magazines, catalogues and directories
- W80 x D260 x H335mm
- Silver mesh design
- Sturdy & durable mesh finish

F00845	each	£7.91
--------	------	-------



B

C Mesh Pen Pot

- Pot for pens, pencils and rulers etc.
- Stylish design perfect for office and school use
- W105 x D70 x H105mm
- Silver mesh design

F00846	each	£2.63
--------	------	-------



C

D Mesh Waste Bin

- Ideal for disposing of waste paper
- Large 18 litre capacity round waste bin
- Solid base and turned top rim
- W355 x D240 x H390mm
- Silver mesh design

F00849	each	£10.25
--------	------	--------



D



CALL US ON 01527 878348



VISIT WWW.FORWARDPRODUCTS.CO.UK

A



A Large Deluxe Bookends

- With foam surface protecting anti slip base
- Dimensions: W150 x D210 x H230mm
- Perfect for books and files

F06914	Black	pk 2	£12.71
--------	-------	------	--------

B



B Metal Bookends

- Quality bookends which will sit comfortably on the end of a row of books or files
- Keeps filing neat and tidy

F03900	L Shaped	pk 2	£6.97
--------	----------	------	-------

C



C Desk Drawer Organizer

- A perfect solution to store your desk accessories in a safe place
- Multiple compartments
- Saves valuable desk space
- Organised storage, your desk accessories are easy to find
- Black. W240 x D340 x H36mm

F00406	Drawer Organiser	each	£12.69
--------	------------------	------	--------

D



D Multicoloured Drawer Tower

- Stylish 4 drawer desktop module
- Accepts documents up to 24 x 32cm in size and up to 450 sheets per drawer
- Smooth action sliding drawers have retaining stop and convenient access slot in base for easy retrieval of documents
- Securely stackable for 2 or more drawer units
- Comes with anti-skid and anti-scratch rubber feet
- Made in Europe and 100% recyclable
- Size: W292 x D386 x H246mm

94381	Multicoloured	each	£40.96
-------	---------------	------	--------



A Studio Class Organizer

- Portable and versatile storage unit with removable pots for the ultimate in organization
- Ideal for pencils, brushes, rulers and much much more!
- Primary colours to brighten up the classroom!

SOC01 each £9.62



B Class Caddy Tabletop Organizer

- Portable desk top tidy for safe storage of pencils, scissors or brushes
- Made from tough, bright plastic

CCTP each £8.10



B

C Desk Organizer

- Keeps commonly used supplies organized and within easy reach
- Includes Scotch Magic tape, Post It notes and index tabs
- 6 storage cavities for pens, pencils, CDs business cards etc.
- Weighted base for stability
- Stylish silver design

86763 Desk Organiser each £24.68



C

D Drawer Tower

- Stylish, high quality filing drawers, a perfect storage solution for all your paper needs
- 5 easy running drawers
- Sturdy construction in black/grey colourway
- Dimensions: W290 x D345 x H220mm

F02253 Drawer Tower each £30.44



D



B



A



D

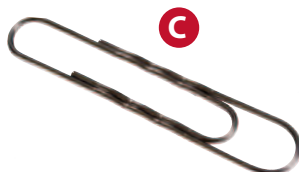

C



F



E



H



G



I

A Striped Paper Clips

- 33mm striped paper clips
- Supplied in a handy storage tub

NSJ001	Striped	tub of 250	£1.75
--------	---------	------------	-------

B Standard Paper Clips

- Silver paper clips
- 33mm standard size
- Supplied in a handy storage tub

NSJ018	Standard	tub of 500	£1.86
--------	----------	------------	-------

C Jumbo Paper Clips

- Silver paper clips
- Jumbo 50mm size
- Supplied in a handy storage tub

NSJ019	Jumbo	tub of 180	£2.19
--------	-------	------------	-------

D Assorted Paper Clips

- Coloured 33mm paper clips
- Supplied in a handy storage tub

NSJ016	Assorted	tub of 250	£2.08
--------	----------	------------	-------

E Foldback Clips

- Assorted colours
- Supplied in a handy storage tub

NSJ014	Foldback	tub of 50	£2.86
--------	----------	-----------	-------

F Brass Coloured Drawing Pins

- Brass coloured drawing pins
- Supplied in a handy storage tub

NSJ010	Brass	tub of 1000	£4.18
--------	-------	-------------	-------

G Drawing Pins Assorted

- Assorted coloured drawing pins
- Supplied in a handy storage tub

NSJ009	Drawing	tub of 750	£4.36
--------	---------	------------	-------

H Push Pins

- Assorted coloured push pins
- Supplied in a handy storage tub

NSJ012	Push Pins	tub of 200	£2.08
--------	-----------	------------	-------

I Indicator Pins

- Assorted coloured indicator pins
- Supplied in a handy storage tub

NSJ008	Indicator	tub of 160	£3.84
--------	-----------	------------	-------



A Assorted Rubber Bands

- Assorted sizes and colours
- Supplied in a handy storage tub

NSJ005	Assorted	100g tub	£2.19
--------	----------	----------	-------



A

B Natural Rubber Bands

- Supplied in a handy storage tub

NSJ015	Rubber Bands	75g tub	£2.08
--------	--------------	---------	-------



B

C Pencil Erasers

- Pencil erasers in assorted colours
- Supplied in a handy storage tub

NSJ030	Erasers	tub of 30	£2.79
--------	---------	-----------	-------



C

D Finger Cones

- 5 Each of sizes 00, 0, 1
- Supplied in a handy storage tub

NSJ021	Finger Cones	tub of 15	£2.19
--------	--------------	-----------	-------



D

E Safety Pins

- Assorted sizes
- Supplied in a handy storage tub

NSJ013	Safety Pins	tub of 200	£2.18
--------	-------------	------------	-------



E

F Key Tags

- Assorted Colours
- Supplied in a handy storage tub

NSJ004	Key Tags	tub of 20	£2.19
--------	----------	-----------	-------



F

G Paper Fasteners (Split Pins)

- 19mm brass paper fasteners
- Supplied in a handy storage tub

NSJ006	Split Pins	tub of 500	£4.40
--------	------------	------------	-------



G

H Pencil Sharpeners

- Extra value pencil sharpeners in handy storage tubs

PSM150	Metal Single	tub of 50	£8.59
PSM225	Metal Double	tub of 25	£8.59
PSP150	Plastic Single	tub of 50	£3.14
PSP225	Plastic Double	tub of 25	£4.17



H

A



A Treasury Tags

- Economical way of holding together punched paper
- Cotton cord, available with plastic or metal end tags

Plastic End Tags

F04570	25mm	pk 100	£1.65
F04571	51mm	pk 100	£1.77
F04573	101mm	pk 100	£1.89
F04575	152mm	pk 100	£2.05

Metal End Tags

F04580	25mm	pk 100	£1.97
F04581	51mm	pk 100	£2.05
F04583	102mm	pk 100	£2.40
F04585	152mm	pk 100	£2.81

B



B Foldback Clips

- Strong steel clips with folding arms
- Manufactured from high quality steel
- Great for documents and loose sheets

F01282	19mm (Black)	pk 10	£0.85
F01283	24mm (Black)	pk 10	£1.47
F01284	32mm (Black)	pk 10	£1.29
F01286	51mm (Black)	pk 10	£2.40



C



C 2-Piece Filing Clips

- Strong steel fastener for binding punched looseleaf papers. 8cm centres
- Holds up to 50mm thickness of papers
- Ideal for use with square cut folders

26083	2 Piece Clips	pk 50	£2.73
-------	---------------	-------	-------

D

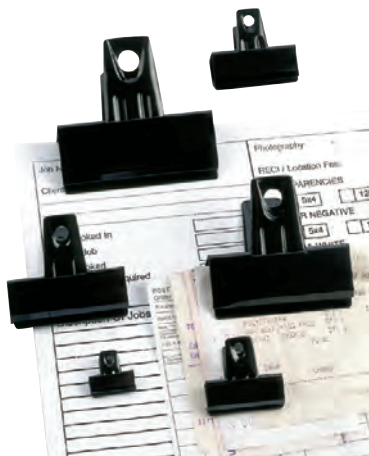

D Heavy Duty Clips

- Traditional heavy duty clips with hanging hole
- Strong steel construction
- Effective way to secure loose papers

F01288	32mm	pk 10	£2.89
F01289	51mm	pk 10	£3.85
F01290	70mm	pk 10	£6.12



A Paper Fasteners (Split Pins)

- Superior quality brass split pins
- Keeps papers organised and together
- Ideal for office and classroom

NSJ006	19mm	pk 500	£4.40
--------	------	--------	-------



A

B Paperclips

- Strong and durable paperclips for holding loose sheets together

F01307Q	26mm No Tear	10 x pk 100	£3.07
F01312Q	32mm No Tear	10 x pk 100	£3.75
F01314Q	32mm Plain	10 x pk 100	£3.27
F01315	32mm Plain	pk 1000	£3.73
F01317	32mm Lipped	pk 1000	£3.73
F01318	50mm No Tear	pk 100	£1.44
27004	77mm Wavy	pk 100	£3.09



B

C Rubber Bands

- Quality rubber bands in a variety of sizes
- 500g boxes - 10% extra than other brands
- High latex content ensures they can be used over and over again

10524	No. 16	1.5 x 60mm	500g	£4.34
10527	No. 19	1.5 x 87mm	500g	£4.34
10533	No. 24	1.5 x 160mm	500g	£4.34
10535	No. 30	3 x 50mm	500g	£5.94
10539	No. 34	3 x 100mm	500g	£4.34
10544	No. 38	3 x 160mm	500g	£4.34
10549	No. 64	6 x 87mm	500g	£4.34
10554	No. 69	6 x 160mm	500g	£4.34
10573	No. 89	12 x 160mm	500g	£5.85
10577	Assorted Sizes		500g	£4.34



C

D Rubber Band Ball Assorted Colours 200g

- Assorted colour rubber band ball
- Each ball 200g (approx 235 bands)

RBBALL	each	£3.05
--------	------	-------



NEW!

D

E X-Band Rubber Bands

- Unique rubber bands which stretch 4 ways
- Ideal for securing files and packages
- Many uses in the office – more secure than string – easier than 2 rubber bands
- Assorted colours
- Available in 50mm and 100mm diameter
- Supplied in 100gram boxes

14679	100mm	each	£6.37
-------	-------	------	-------



E



A Wizard Glue Sticks

- Economical but reliable, solvent free gluesticks

GS10Q	10g Small	pk 12	£3.11
GS20Q	20g Medium	pk 9	£2.84
GS40Q	40g Large	pk 8	£3.50
GS4040	40g Large	pk 40	£13.86
GS40200	40g Large	pk 200	£66.68



B Pritt Sticks

- Brand leading gluesticks
- CPPSL100 is supplied in a Gratnell's tray with a clear lid

PSM12	Medium 20g	pk 24	£25.50
PSL10	Large 43g	pk 10	£13.11
PSL50	Large 43g	box 50	£64.03
PSL100	Large 43g	box 100	
	Includes 4 FREE		£103.84
CPPSL100	Tray 43g	pk 100	£130.22
PSJ90	Jumbo 90g	each	£4.74



C Sticky Fixers

- Ideal for fixing, mounting and display work
- Each pad can hold up to 90g in weight
- Permanent adhesive

37984	12 x 25mm	pk 56	£1.45
-------	-----------	-------	-------



D Sticky Fixer Strip

- Foam strip coated both sides with permanent adhesive
- Ideal for fixing, mounting and display work
- 1 metre of foam can hold up to 9kg in weight
- Each roll is 25mm x 3m

F03796	Sticky Fixer	each	£3.09
--------	--------------	------	-------



E Hook & Loop S/A Pads

- Self adhesive hook and loop pads
- Great for hooks, signs, pictures and displays

4542		pk 24	£2.17
------	--	-------	-------



The Undisputed King of the Glue Sticks

"An Excellent alternative to the leading brand. We find them better quality than economy glue sticks, and certainly a lot less money than Pritt Sticks"
Sefton Park School



Economy Stick
Slightly cheaper
Inferior performance



Pritt Stick
Equivalent Quality
£41.85 more per 100

Order Details

QSTICK	Single 40g Quickstick	Each	£0.72
QST35	Class Pack 40g Quickstick	Pk 35	£23.99
QST100	Bulk Box 40g Quickstick	Pk 100	£61.99
CPQST100	Gratnell's Tray 40g Quickstick	Pk 100	£69.60

Call for your free sample today!



CALL US ON 01527 878348



VISIT WWW.FORWARDPRODUCTS.CO.UK

A



A Invisible Tape

- Invisible on paper, mends tears without a trace
- You can write on it, type on it, photocopy it or fax it without leaving a ghost mark
- 18mm x 33m

27011	Invisible Tape	each	£0.98
-------	----------------	------	-------

B



B Masking Tape

- Ideal for spray paint masking and general studio and classroom use
- 24mm x 50m

F01789	Masking Tape	pk 12	£14.89
--------	--------------	-------	--------

C



C Brown Packing Tape

- Seals packages securely and neatly.
- Polypropylene tape which is strong and waterproof
- 50mm x 66m

27010	Brown Tape	pk 6	£6.59
-------	------------	------	-------

D

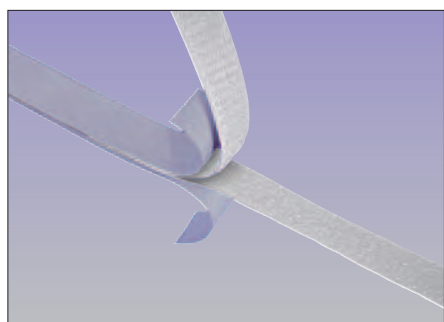

D Hook & Loop Tapes

- Superior quality self adhesive backed velcro tapes
- Guaranteed to perform as well as the leading brand but at a lower cost
- 20mm x 25m rolls

H2025A	Hooks	each	£25.81
L2025A	Loops	each	£25.81



A Adhesive Tape

- Strong polypropylene adhesive tape
- Seals fast and holds tight
- Ideal for packing, sealing and mending
- Available in a choice of sizes

Small Rolls

27013	19mm x 33m	pk 8	£2.62
27014	24mm x 33m	pk 6	£2.88

Large Rolls

27015	12mm x 66m	pk 12	£5.48
27016	19mm x 66m	pk 8	£5.30
27017	24mm x 66m Economy	pk 12	£4.95
TAPE	24mm x 66m Standard	pk 6	£4.77



A

B Tape Dispensers

- Tough black plastic tape dispensers
- Large dispenser takes 33m or 66m tapes up to 25mm wide
- Small dispenser takes 33m tapes up to 19mm wide
- Non slip rubber base prevents slipping

11010	Large	each	£3.30
F01294	Small	each	£2.51



B

C Original Sellotape

- The nation's No 1 clear sticky tape
- Can be torn by hand so no need for scissors or teeth
- Non static - for better control, non-tangle taping
- Kinder to the environment
- Made from biodegradable cellulose
- Flow wrap rolls in boxes

Large Rolls

F0032	19mm x 66m	pk 16	£21.33
F0036	24mm x 66m	pk 12	£23.88
F0046	48mm x 66m	pk 6	£22.85

Small Rolls

F0836	18mm x 33m	pk 8	£9.09
F0838	24mm x 33m	pk 6	£8.31



C

D Double Sided Tape

- Tough vinyl tape with double side adhesive supplied on a liner
- Suitable for holding, joining and mounting
- 25mm x 33m

F02221	Double Sided	pk 6	£22.98
--------	--------------	------	--------



D



CALL US ON 01527 878348



VISIT WWW.FORWARDPRODUCTS.CO.UK

A



A Quicktac Adhesive Putty

- Economical reusable adhesive will hold papers or light objects to most surfaces without marking

QTA140	140g	each	£1.44
--------	------	------	-------

NEW!

B



B Wizard White Tack Adhesive Putty

- Reusable adhesive Wizard White Tack
- Clean, safe and easy to use
- For best results, use on non-porous surfaces
- 140g

801072	140g	each	£0.89
--------	------	------	-------

C



C Blu-tack Adhesive Putty

- The original reusable adhesive putty

BLU120	Economy Pack 120g	each	£1.04
80108	Economy Pack 120g	pk 12	£12.46
BLU60	Handy Size 60g	each	£0.90
F00181	Handy Size 60g	pk 12	£8.57

D



D White Tack Adhesive Putty

- Sticks paper or small objects to a multitude of surfaces
- Fixes pictures, notes, memos, cards and decorations
- 60g handy sized packs

WHI60	60g	pk 12	£8.64
-------	-----	-------	-------

E



E Spray Mount Adhesive

- Ideal for repeated mounting of light materials such as film, acetate and layout paper
- Transparent and will not soak through or wrinkle paper
- CFC Free
- 400ml cans

QMAD	Economy	each	£5.15
3MSPRAY	3M Spray Mount	each	£13.88



A Children's Ruler Scissors

- Slightly larger 13.3cm convenient size
- Blade is ruled in centimetres
- Block contains 26 right-handed, 6 left-handed scissors

RSRHR	Right-Handed	pk 12	£5.13
RSLH	Left-Handed	pk 12	£5.13
SB32	Block & 32 Pairs	pk 32	£16.45



A

B Classpack of Children's Scissors

- Classpack of 84 right handed and 12 left handed scissors
- 13cm scissor with centimeter ruler marking on blade

SC56410	Classpack	pk 96	£33.69
---------	-----------	-------	--------



B

C Craft Scissors With Blue Plastic Loop Handle

- Easy grip scissors, lightweight with a continuous loop plastic handle
- Operated by squeezing gently using fingers and thumb, or fingers and palm of the hand
- Automatically reopens when the pressure is released
- Right handed

SCCRAFT		each	£2.59
---------	--	------	-------



C

D Office Scissors

- Quality scissors for a sharp clean cut
- Comfortable ergonomic handles
- Colour may vary

F01229	13cm (5")	each	£1.32
F01228	17cm (6½")	each	£1.97
F01227	23cm (8")	each	£2.40
F02340	25.5cm (10")	each	£2.64



D

E Premium Office Scissors

- Premium scissors with comfortable handles.
- Grey grips and green handles
- 21cm/8" overall length

F03987	Premium	each	£7.18
--------	---------	------	-------



E

A

25
Sheet
Capacity**A Electric Stapler**

- Professional mains-powered stapler
- Single-handed auto operation
- Fast push-button front staple loading
- Low staple indicator light
- 25 sheet stapling capacity
- Anti-jam & anti-twist feature
- Rotating anvil for stapling or pinning
- Takes 26/6 or 24/6 staples
- 2 year warranty

5990 Electric each £78.97

B

70
Sheet
Capacity**B Rapesco Heavy Duty Electronic Stapler**

- Loads staple cartridge 5000 for continuous stapling action without reloading
- Incorporates flat clinch mechanism
- Adjustable throat depth 6-18mm
- Carrying handle
- Capacity for 70 sheets of 80gsm paper
- Staple cartridge contains 5000 staples
- 2 year warranty

EH70F Stapler each £317.10
STEH70FE Staple Cartridge each £22.84

C

90
Sheet
Capacity**C Rapesco Heavy Duty Stapler**

- Robust half strip stapler with full metal inner chassis
- Staple up to 90 sheets
- 50mm opening
- Uses 60% less effort due to the handle design
- Top loading
- Adjustable paper guide
- 15 year manufacturers guarantee
- Takes 923/8 or 24/6 hard wire staples

RP1170 Stapler each £23.41

15 YEAR
WARRANTY

D

15 YEAR
WARRANTY**D Rapesco ECO HD-140 Heavy Duty Stapler**

- Capacity up to 140 sheets (80gsm)
- 15 year guarantee
- Full strip, push button front loading, and with a soft rubber handle grip
- Non-slip rubber feet

SRECOHD Stapler each £26.76
SR92317 912/17mm Staples pk 1000 £4.68

A Rapesco Staplers

- Attractive half strip, top loading stapler
- 20 sheet capacity
- Will take 26/6mm and 24/6mm staples
- 10 year warranty

30280	Blue	each	£3.76
-------	------	------	-------



Zack
RECOMMENDS



10 YEAR
WARRANTY

B Plastic Staplers

- Manufactured from ABS with inner metal chassis for added strength
- Takes 24/6 or 26/6 staples

ST538	Half Strip	each	£1.85
ST548	Full Strip	each	£2.19



LOWEST
PRICE

B

C Metal Staplers

- Quality all metal construction with ABS cap for comfort
- 20 sheet capacity
- Takes 24/6 or 26/6 staples

ST535	Half Strip	each	£2.28
ST545	Full Strip	each	£3.07

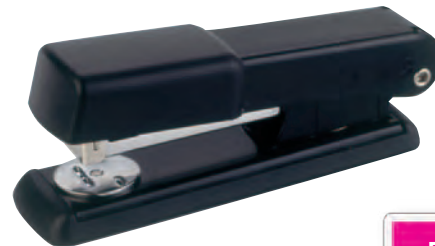

FOR STAPLES

SEE PAGE 155

C

D Rapesco Flat Clinch Stapler

Handy Stapler with comfortable ergonomic design, which creates flat staples, allowing for neater stacks of stapled sheets.

- All metal inner channel
- Personalisation window
- Staple 20-25 sheets
- Takes 26/6 or 24/6 staples

RP1143	Flat Clinch	each	£6.45
--------	-------------	------	-------



D

E Long Arm Stapler

- Long reach stapler for large sheets of paper
- Quality steel construction with rubber finger pad
- 20 sheet capacity
- Takes 24/6 or 26/6 staples

ST590	Long Arm	each	£12.45
-------	----------	------	--------



5 YEAR
WARRANTY

E

A



A Economy Staple Remover

- Lock down device for added safety
- Prevents damage to documents
- Suitable for use with all standard staples

STR4	Economy	each	£0.35
------	---------	------	-------

B



B RapESCO Staple Remover

- Stylish design with comfortable grip.
- Easily removes staple by simply sliding underneath
- Contoured grip

101BU	Blue	each	£2.39
101BK	Black	each	£2.39

C



C Swingline Staple Remover

- Robust metal staple remover removes standard, heavy duty or box staples
- Smart and ergonomic design which is simple to use
- Removes staples from documents of up to 160 sheets

37201	Swingline	each	£11.26
-------	-----------	------	--------

D



D Standard Staples

- Suitable for use in our staplers and tackers
- Low cost, high value alternative to big brands

ST26/6	26/6 Staples	pk 5000	£0.99
ST24/6	24/6 HD Staples	pk 5000	£0.85
ST13/6	13/6 Tacker Staples	pk 5000	£2.30

E



E Premium Staples

- Suitable for use in Rapid staplers and tackers plus most other machine brands

ST108	24/8 HD Staples	pk 5000	£8.48
ST138	13/8 Tacker Staples	pk 5000	£7.88
ST236	23/6 Tacker Staples	pk 1000	£1.32
ST238	23/8 Tacker Staples	pk 1000	£1.36
55541	53/8 Tacker Staples	pk 5000	£7.88
HTST6	66/6 Staples	pk 5000	£5.28
STEH70FE	RapESCO 70F Cartridge	pk 5000	£22.84
92314	Power Stapler Cartridge	pk 4000	£10.11



A Metal Tacker

- Heavy duty tacker ideal for use in schools and offices
- Tough all-metal construction
- Jam removal feature
- Easy-squeeze handle
- Takes either 13/4-8mm or 53/4-8mm staples
- 3 year warranty



8512 Metal Tacker each £12.36

B Rapesco Z Duo Tacker

- Powerful and compact tacker with ABS body and premium steel working parts
- Safety lock down handle
- Bottom loading with staple view guide
- Linear powercurve feature reduces 'snap'
- No recoil
- Margin adjustment guide for accuracy
- Wrist strap
- Uses 13/6, 13/8 and 53/8 staples
- 3 year warranty



ZDUO Rapesco Tacker each £6.58

C Lightweight Tacker

- Well built tacker for everyday use
- ABS body with metal handle
- Internal parts made from high quality steel
- Uses 24/6 staples
- 3 year warranty



8502 Lightweight each £5.27

D Rapesco Heavy Duty Metal Tacker

- Silver metal zinc die cast tacker
- Unique moveable margin adjuster for accurate stapling
- Foldaway lock down handle for safety
- Ideal for schools, hobby crafts and general stapling applications
- Supplied with 300 staples and wrist strap
- Uses 13/6, 13/8 or 53/8 staples
- 3 year warranty



F05370 Heavy Duty each £15.96

E Rapesco Hardened Steel Tacker

- Tough all metal tacker with hardened steel working parts and driver blade
- Smooth die cast finished body
- Extra comfortable handle with locking device
- Adjustable driving force/pressure control for perfect stapling
- Unique margin adjuster for more accurate stapling
- Uses 13/6 or 13/8 staples
- 3 year warranty



F05371 Hardened Steel each £20.37

A

10
Sheet
Capacity



LOWEST
PRICE

A Economy Punch

- Lightweight, 2 hole desk punch for small quantities of paperwork
- Handle hold-down device and paper guide included
- 10 sheet capacity

F01233	Economy	each	£2.45
--------	---------	------	-------

B

22
Sheet
Capacity



B Medium Punch

- Supplied with an integrated paper measuring guide and a useful handle lock down mechanism for ease of storage
- Punches up to 22 sheets of 80gsm paper

F01234	Medium	each	£3.60
--------	--------	------	-------

C

27
Sheet
Capacity



C Standard Punch

- Standard duty 2 hole punch capable of punching up to 27 sheets
- Supplied complete with lock down feature and paper measuring guide

F01235	Standard	each	£5.02
--------	----------	------	-------

D

35
Sheet
Capacity



D Heavy Duty Punch

- Designed for effortless punching operation
- Capable of punching up to 35 sheets
- Includes lock down switch and paper measuring guide

F01236	Heavy Duty	each	£8.70
--------	------------	------	-------



A Rapesco Easy Press X5-30PS 2 Hole Punch

- Tough, easy to use hole punch
- 60% less effort
 - Locking device for safety & storage
 - Flip-open confetti tray
 - Punch up to 30 sheets
 - 15 year manufacturers guarantee

RP1171 2 Hole Punch each £11.40



30
Sheet
Capacity

15 YEAR
WARRANTY

B Extra Heavy Duty Punch

- Long handle design for effortless operation
- Includes lock down switch and paper measuring guide
- 63 sheet capacity

F01237 Extra Heavy Duty each £18.32



B

63
Sheet
Capacity

5 YEAR
WARRANTY

C 4 Hole Punch

- 4 hole punch with single piece handle featuring a lock down mechanism
- Capacity 16 sheets of 80gsm paper
- Integrated paper measuring guide for added accuracy

F01238 4 Hole Punch each £6.71



C

16
Sheet
Capacity



A Duracell Procell Batteries

- Procell industrial alkaline batteries last much longer than ordinary zinc carbon batteries
- 4 year shelf life
- Guaranteed against leakage

PROAAA	AAA	pk 10	£3.30
PROAA	AA	pk 10	£3.22
PROD	D	pk 10	£9.76
PRO9V	9V/PP3	pk 10	£10.89



B Duracell Plus Batteries

- Long lasting batteries designed for use in non high drain appliances

F03814	AAA	pk 4	£3.51
F03812	AA	pk 12	£9.63
F03817	C	pk 2	£6.31
F03820	9V/PP3	each	£3.15



C ACCU Rechargeable Batteries

- One of the most advanced rechargeable battery systems available
- Up to 40% longer service life
- Fast charging
- Ideal for high drain appliances

F06085	AAA	pk 4	£15.10
F06571	AA	pk 4	£14.54



D Multi Charger

- Compact and lightweight
- Ability to charge multiple sizes at the same time: - Up to 8 x AA / AAA, 4 x C/D and 1 x 9V
- Enclosed charging compartment provides protection

F08832	Multi Charger	each	£33.83
--------	---------------	------	--------



A Cash Boxes

- Sturdy cash boxes with rounded corners
- Recessed metal handle and removable coin tray

11311	8" Black	each	£11.25
11312	8" Red	each	£11.25
11313	10" Black	each	£11.75



A

B Lockable Key Cabinets

- Features metal key hanger strips
- All steel construction available in grey finish
- Includes wall fixing kit, cylinder lock with two keys and key labelling strips

32881	20 Key	each	£16.91
32883	48 Key	each	£22.22
32886	80 Key	each	£31.42



B

C DoorSense Fire Alarm Activated Hold Open Device - Black

Need to hold doors open as part of your infection control strategy to stop people unnecessarily touching door handles/push plates? Achieve it legally with this device

- A sophisticated, wire free, intelligent learning electronic device which legally holds open a fire door until the fire alarm sounds

FJ8755A	each	£156.27
---------	------	---------



NEW!

C

D Door Wedge Grey Rubber

- Standard grey rubber door wedges for propping doors open

GDW100	each	£1.35
--------	------	-------

NEW!



D

E Door Stop & Wedge

F09133	Heavy Duty	each	£4.11
F09132	Standard	pk 2	£4.11



E

A



A Radio Controlled Clock

- Radio controlled office wall clock with a stylish metal case
- 300mm diameter
- Brushed steel case with glass lens
- Keeps perfect time by itself. Never 'change the time' again!

RWC	Radio Controlled	each	£17.71
-----	------------------	------	--------

B



B The Original Exam Clock

- Large 300mm clock
- 12/24hr
- Plastic case
- Arabic dial
- Takes 1 AA battery (not included)

EWC	Exam Clock	each	£9.22
-----	------------	------	-------

C



C Silver Office Wall Clock

- Stylish office wall clock in silver
- 250mm diameter
- Plastic case
- Glass lens
- Arabic dial
- Takes 2 AA batteries (not included)

OWC	Office Wall Clock	each	£12.08
-----	-------------------	------	--------

D



D Colourful Wall Clocks

- 255mm diameter
- Takes 1 AA battery (not included)

92301	White	each	£13.21
92302	Black	each	£13.21
92303	Red	each	£13.21
92308	Blue	each	£13.21

E



E Stop Watch

- Stylish silver stop watch
- 1/100 second up to 24 hours
- Lap and split timing
- Water resistant 30m
- Batteries included
- Takes lithium battery CR2032 3V

TIM901	Stop Watch	each	£6.56
--------	------------	------	-------

F



F Digital Magnetic Countdown Timer

DCT30		each	£7.99
-------	--	------	-------



05

OFFICE MACHINES

LAMINATING & BINDING	163-166
TRIMMERS & GUILLOTINES	167-169
TELEPHONES	170
LABELLING MACHINES & REFILLS	171-172
SHREDDERS	173-174
PRINTERS & FAX MACHINES	175
COMPUTER EQUIPMENT	176-177
POWER TROLLEYS	178
DATA STORAGE	179
COMPUTER ACCESSORIES	180-181



NEW!



A GBC Foton 30 Automatic Laminator

- Save heaps of time with this fully automatic office laminator! Simply load your documents into the Auto Feed tray, press the start button and it automatically laminates!
- Automatically laminates up to 30 A4/A3 documents at a time
- Automatic auto feed paper alignment
- Control panel to allow easy switching between automatic and manual mode
- Includes a 75 Micron 306mm x 15.2m starter cartridge

GBC50200	Laminator	each	£480.00
----------	-----------	------	---------

Cartridges

GB59731	75 mic 306mm x 56.4m	£55.20
GB59732	125 mic 306mm x 42.4m	£55.20
GB59975	100 mic 306mm x 42.4m	£55.20

B



B Ultra Heavy Duty A3 Laminator

- Robust Metal Pouch Laminator made in the USA. For years of trouble free running, the TLC 7021 is the laminator to buy. Built to cope with regular use and a variety of pouch sizes and types.

Construction features include:

- Strong Metal Case
- Fan cooled outlet table
- Finned heat sink for additional cooling
- Brushless gear motor for long, trouble-free life
- All electrical parts earthed to the chassis
- Moulded silicone rollers withstand elevated temperatures.
- On light and temperature ready lights
- Can be used continuously

UHDLAM	each	£399.00
--------	------	---------

We recommend pouch carriers are used in all our laminating machines.

- Keeps rollers clean
- Wrinkle free documents
- Less jams
- Ability to laminate smaller items within the pouch
- First class results

FOR LAMINATING POUCHES

SEE PAGE 165

C



LOWEST PRICE

C Q Connect A3 Personal Laminator

- Warm-up time 3-5 minutes
- Laminating speed 26cm/min
- Maximum pouch thickness - 250 microns

14660	A3	each	£46.46
-------	----	------	--------



A Swordfish A3 & A2 Armoured Laminators

- Rugged steel casing
- Laminates an A4 sheet in approx. 32 secs
- Fast 660mm/min lamination
- Four large 25.6mm precision rollers
- 4-6 minutes warm up time
- Sophisticated temperature management
- Reverse control



A

OSWALA3	A3	each	£146.27
OSWALA2	A2	each	£219.82

B Heavy Duty Expert Laminators

- Fast warm-up time
- Ultra tough metal body with heavy duty chassis
- Engineered for high volume educational use & laminates all types of pouches to 500 mic
- Easy to use operating instructions on machine front
- Anti-jam reverse button
- Digital display for accurate temperature selection
- 4 rollers designed for quality results: perfect photo lamination



B

EXPR320*	A3	each	£298.10
----------	----	------	---------

* While stocks last

C Peak Educator Laminator

- A versatile, reliable laminator for consistent high-quality lamination
- Jam-free laminating for all types of documents including cut-up pieces
- Suitable for a multitude of document types from newspaper to thin card
- Designed for frequent, everyday use

NEW!



C

PELA3	A3	each	£232.40
PELA2	A2	each	£329.90

D Card Pouch Carriers

- Prevent pouch jamming when you use our card carriers
- Prolong the life of your laminator by preventing glue seepage
- Available in A3 and A4 sizes



D

CPCA4	A4	pk 10	£3.23
CPCA3	A3	pk 10	£4.38

E Teflon Pouch Carriers

- The Lifejacket™ is designed to eliminate the risk of jamming or wrapping around the rollers which can be a problem when laminating smaller items in an oversized pouch
- Made of Teflon® which allows heat to completely penetrate through the pouch giving excellent lamination results every time and will work on most laminators
- Very long lasting and eliminates the need to continually buy standard card carriers



E

LPTCA4	A4	each	£9.70
LPTCA3	A3	each	£18.69



- Generous size pouches for strong long-life finish
- Easier to insert paper due to anti-static design
- Rounded corners for extra safety
- High gloss for a glass-clear finish



A A5 Gloss Laminating Pouches

LA5150	150 mic	pk 100	£4.57
LA5200	200 mic	pk 100	£6.92
LA5250	250 mic	pk 100	£8.33

B A4 Gloss Laminating Pouches

			1-9	10+
LA4150	150 mic	pk 100	£7.82	£6.32
LA4200	200 mic	pk 100	£9.44	£8.44
LA4250	250 mic	pk 100	£10.49	£9.49

C A3 Gloss Laminating Pouches

			1-9	10+
LA3150	150 mic	pk 100	£15.09	£13.99
LA3200	200 mic	pk 100	£18.52	£17.35
LA3250	250 mic	pk 100	£20.98	£19.79

NEW!

D

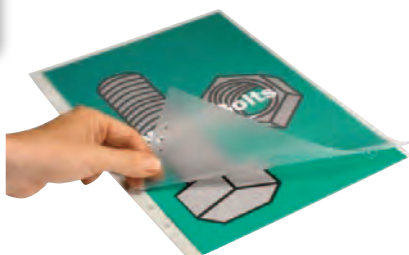

D Pre-Punched Laminating Pouches A4 150mic Gloss

- 150 micron gloss laminating pouches
- Pre-punched for quick filing
- High quality, low melt

PLA4150	pk 100	£13.39
---------	--------	--------

E



E ID Badge Size Gloss Laminating Pouches

- Ideal for name badges, business cards & small signs
- Gives professional looking results

65 x 95mm

LP6799	250 mic	pk 100	£3.30
--------	---------	--------	-------

54 x 86mm

LP5486	250 mic	pk 100	£3.39
--------	---------	--------	-------

F



F Matt Laminating Pouches

- Eliminate glare from glossy surfaces - no more reflections
- Suitable for pencil and ball pen usage

LPMA4150	A4	150 mic	pk 100	£10.65
LPMA3150	A3	150 mic	pk 100	£21.99
LPMA4200	A4	200 mic	pk 100	£16.15
LPMA3200	A3	200 mic	pk 100	£27.15



A Q Connect Comb Binder

- Ideal for occasional use
- Manual punching up to 12 sheets
- 4 hole punching in the back
- Metal base
- Maximum binding capacity 150 sheets with a maximum binding ring capacity of 51mm

14654Q each £47.36



A

B GBC C200E Electric Comb Binder

- Simple push button electric punch technology for fast and efficient binding. Ideal for moderate use in the mid size office
- Binding capacity up to 330 sheets using a 38mm comb
- Punch capacity up to 15 sheets (80gsm)
- Electric punch: Easy access punch button
- LEDs indicate standby, full chip tray & jam
- Anti jam function: auto reverse
- 2 year warranty

F04692G each £248.42



B

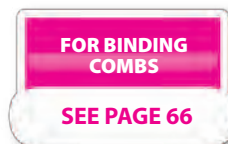

C GBC C250 All Metal Comb Binder

Ideal for everyday, high volume use, the C250 Pro is a versatile, tough and durable comb binder. Easy to use and with a large capacity clippings tray, it can punch up to 20 80gsm sheets and bind up to 450 sheets.

- Binding capacity up to 450 sheets using a 51mm comb
- Punch capacity up to 20 sheets (80gsm)
- Robust aluminium construction
- Easy access, high volume clippings tray
- 2 year warranty

23642 each £393.50



C

D GBC C450e High Speed Electric Comb Binder

This large capacity electric machine is ideal for frequent use in busy environments. Complete with the unique GBC Quickstep workflow guide, the C450e makes the binding process easy and ensures perfect results every time.

- Binding capacity up to 450 sheets using a 51mm comb
- Punch capacity up to 25 sheets (80gsm)
- Electric punch: Easy access punch button
- Unique paper separator: divides your pages into stacks of 25 to maximise punch efficiency
- Auto centering: positions the pages for perfect punching
- Quickstep workflow guide for simple, intuitive operation
- 2 year warranty

23641 each £499.18



D



CALL US ON 01527 878348



VISIT WWW.FORWARDPRODUCTS.CO.UK

RAZORBACK

HEAVY DUTY ROTARY TRIMMERS



Cut through those endless piles of trimming jobs easier and quicker. Your hand will love the soft grip cutting head, and a self sharpening blade makes light work of up to 18 sheets of paper.

Quickly line up the paper and cut in the right place every time, with the clear paper clamp and secure, magnetic paper guide.

- 3-year Razorback Warranty
- Spare parts readily available
- Strong metal base with printed paper sizes

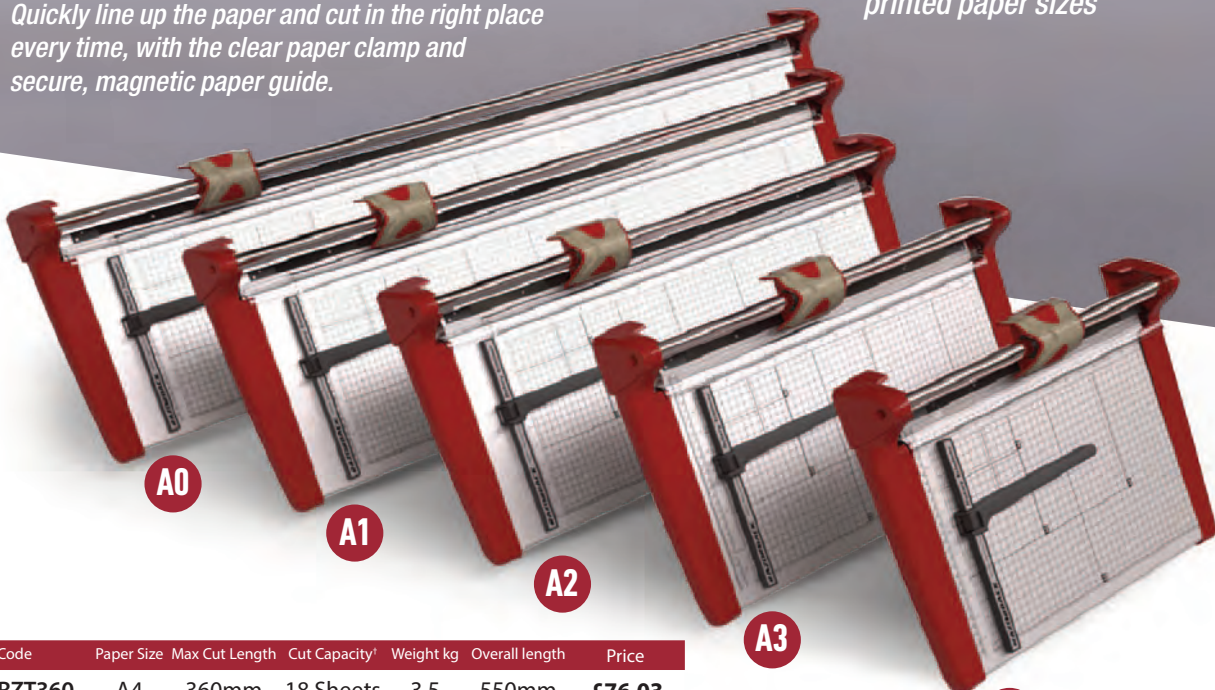

Code	Paper Size	Max Cut Length	Cut Capacity [†]	Weight kg	Overall length	Price
RZT360	A4	360mm	18 Sheets	3.5	550mm	£76.03
RZT480	A3	480mm	16 Sheets	4.3	670mm	£114.94
RZT670	A2	670mm	16 Sheets	6.4	860mm	£138.36
RZT960	A1	960mm	15 Sheets	17.8	1050mm	£204.18
RZT1300	A0	1300mm	12 Sheets	15.8	1400mm	£283.65

[†]Cut capacity is based on 80gsm sheets



SuperCut™
Sustained Precision

A cut above
the rest.



Precise smooth
cuts, time after time

- > Precise, smooth cuts, time after time
- > Scratch-resistant and easy-to-clean metallic finish
- > Clear paper clamp and adjustable magnetic back stop for perfect cuts
- > Suitable for paper, photo paper, card, thin plastic, laminating pouches, foil and more
- > 3 year warranty and spares available for complete peace of mind



Save worktop space and
catch all the trimmings with a
**FREE STAND & TRIMMINGS
CATCHER**
WITH THE 2 LARGEST SIZES

3
years
warranty



Code	Size	Max Cut Length	Cut Capacity¹	Price
RT670	A2	670mm	12 (1.2mm)	£130.83
RT480	A3	480mm	12 (1.2mm)	£108.53
RT360	A4	360mm	15 (1.5mm)	£74.99

Code	Size	Max Cut Length	Cut Capacity¹	Price
RT1300	A0	1300mm	9 (0.9mm)	£292.84
RT960	A1	960mm	12 (1.2mm)	£246.74



CALL US ON 01527 878348



VISIT WWW.FORWARDPRODUCTS.CO.UK

NEW!

A

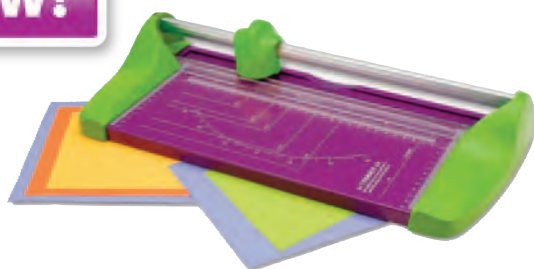

A SuperCut 5-in-1 Creative Cutter

- Quality A4 cutter in with a straight, wavy, deckle, perforated or creasing cut heads
- Cuts up to 8 sheets of 80gsm paper or 1 lamination on the 'straight cut' setting, or 2 sheets of 80gsm on the creative heads
- Perfect for arts and craft, including card making, and classroom displays
- The strong metal base is pre-printed with a size guide for accurate trimming
- Sometimes even SuperCut blades gets worn with regular use, so replacement blades are available and easy to fit

SCR8C each £35.75

B

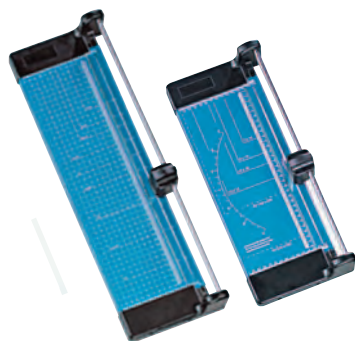

B Personal Rotary Trimmers

- Cutting capacity up to 7 sheets of 80gsm paper
- Solid metal cutting table
- Ideal for cutting cards and photos
- Great for office use

ART323	A4	each	£17.98
ART453	A3	each	£29.98

C



C Dahle Personal A4 Guillotine

- Guillotine with sturdy metal table
- 8 sheet capacity
- Upper and lower steel blade
- Hand clamp and 2 scalebars, handclamp to hold item to be cut in position
- Recessed grips for comfortable carrying
- 2 year warranty

50200 each £56.38

2 YEAR WARRANTY

D



D Avery Medium Capacity Guillotines

- 15 sheet capacity
- Built in locking mechanism for extra safety
- Redesigned table area markings to improve accuracy of cut, including: paper and photographic sizes and scale bars in both millimeters and inches
- Handle remains in the upright position for extra safety and ease of paper positioning
- 5 year warranty (doesn't cover blunt or broken blades)

14028AV	A4	each	£69.26
14029AV	A3	each	£84.25

3 YEAR WARRANTY

E

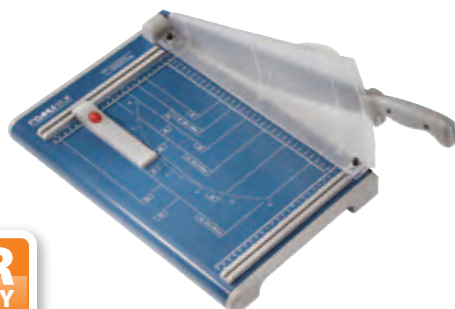

E Dahle Heavy Duty Guillotines

- Robust guillotines with sturdy metal tables
- 15 sheet capacity
- Screw mounted, flat ground upper blade & ground blade made of Solingen cutlery steel
- Hand clamp with integrated finger guard
- 2 scale bars and adjustable backstop
- Recessed grip for comfortable carrying
- 2 year warranty

30533	A4	each	£82.79
30534	A3	each	£123.27

2 YEAR WARRANTY



A Philips Voice Tracer Stereo Digital Recorder

- Stereo MP3 digital voice recorder for recording conversations and notes
- Large backlit LCD display for easy control in any light
- Easy plug-and-play compatibility with Windows PCs and Macs
- 4GB internal memory with MicroSD memory card slot for expansion
- 2x AAA batteries for long-lasting 38 hour battery life
- Built-in FM radio with recording function
- 3.5mm headphone and line-in ports

36130 each £55.52



A

B BT Converse 2100 Telephone

Corded Black Telephone

Entry level business phone with a data port, headset port & full switch compatibility.

- 3 quick dial memories • 3 ring tones
- Headset socket • Inductive coupler
- PBX compatible • Wall Mountable
- Earpiece volume control

MTCON21 each £39.34



B

C BT Paragon 650 Telephone & Answering Machine

Multi-functional phone with comprehensive features for business use. With hands free, call waiting and induction hearing among it's many features.

- Digital Answering Machine
- Mobile phone SIM card reader/writer
- Send and receive text messages
- 200 Entry directory
- Caller Display with 50 number calls list

MTPAR65 each £60.48



C

D BT Diverse 7100 Plus Cordless Telephone Additional Handset & Charger

- 100 name & number directory
- 4 line display with backlight
- Handsfree • SIM card reader
- 27minute playback time

MTDIV710 each £40.45



D

E Motorola TLKR T62 Two-Way Radio

Tough, stylish & ideal for staying connected during outdoor activities. Packed with functionality, multiple call tones & a range up to 8km. Rechargeable batteries.

- Licence free PMR446 radios
- 8 channels + 121 codes
- Free calls • Scan/monitor
- 5 call tones • Hands free feature
- LCD display
- Headset connector • Room monitor
- Set of 2

MMTWT60 pk 2 £62.43



E

A

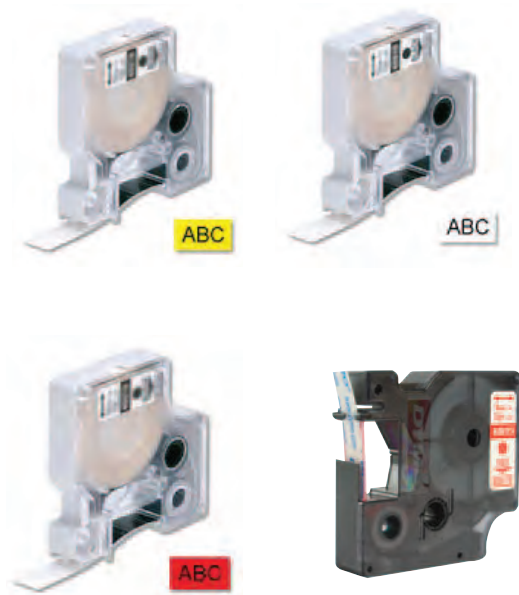

D1 Tapes for Dymo Labelmakers

Created specifically for Dymo LabelManager and LabelPoint machines, Dymo D1 tapes offer the performance and variety you need for any labelling job. In your office, your workshop, your store or anywhere else you work.

- 7m long tapes with gloss finish
- Price may fluctuate

Impression	6mm	9mm	12mm	19mm	24mm
Black/White	43613	40913	45013	45803	53713
White/Clear			45020		
Black/Red		40917	45017	45807	
Black/Yellow		40918	45018	45808	
Black/Clear	43610	40910	45010	45800	
Black/Blue		40916	45016		
Black/Green			45019		
Red/White		40915	45015		
Blue/White		40914	45014		
White/Black			45021		
Price	£12.30	£13.50	£13.92	£21.76	£24.68

For Dymo Pocket, 1000+, 2000, 3500, 4500, 5500, LM 100, LM 100+, LM 150, LM210D, LM220P, LM120P, LM260P, LM 360D, LM 400, LM 450, LP 100, LP 150, LP 200, LP 250, LP 300, LP 350, LM420P, LMPnP, LM280 and LMPNP WL



B



B DYMO LetraTag Tapes

91200	Black/White	each	£5.28
-------	-------------	------	-------

C



C DYMO LabelWriter Labels

- Paper labels
- Permanent adhesive

Code	Description	Size(mm)	Price
99012	Large Address	89 x 36	£21.00
	2 rolls/box, 260 labels/roll		
99010	Standard Address	89 x 28	£11.42
	2 rolls/box, 130 labels/roll		
99017	Suspension File Label	50 x 12	£11.95
	1 roll/box, 220 labels/roll		
11356	Small Name Badge	89 x 41	£20.58
	1 roll/box, 300 labels/roll		



A Brother PTD600VP Desktop Label Printer

Portable stand-alone label printers with PC connectivity and full QWERTY keyboard.

- Create labels with a choice of fonts, symbols and barcodes using the keyboard and one-touch function keys
- Plug in via USB to print labels from your PC
- Powered by AC adaptor or 6 x AA batteries (not supplied)
- Backlit monochrome display
- Prints on TZ tape up to 18mm wide, up to 20mm per second
- Comes with 18mm tape cassette, USB cable and carry case



A

MBA74613	each	£96.34
----------	------	--------

B Brother PTH110 Handheld Label Printer

- A compact labeller with a wide variety of tapes in various widths and colours.
- Delivers great functionality, including cable labels, sequential numbering, reverse & vertical text modes
- A memory that shows the symbol history and is able to save the 15 most favourite designs
- The PT-H110 includes 15 frame styles, 3 fonts, 10 font styles and 253 symbols
- Includes a 12mm black on white TZe tape
- Optional AC adapter
- 16 character LCD graphic display
- Cable labelling
- 20mm per second print speed
- Tape cutter
- 3.5 / 6 / 9 / 12mm TZe tapes



B

MBA71009	each	£38.47
----------	------	--------

C Brother TZ Labelling Tape

M8095	12mm x 8m Black on Yellow	each	£15.41
M8109	18mm x 8m Black on Yellow	each	£17.31



C

A



A Q Connect Q8CC Cross Cut Shredder

- Shreds up to 8 sheets of 75gsm paper
- Shreds credit cards, small staples and small paperclips
- Separate strip cut slot shreds CDs
- Safety cut out when the shredder head is lifted
- Integral handle for easy shredder head removal
- Reverse function to clear paper jams
- Overheat protection

15546	each	£54.96
-------	------	--------

B

16
Sheet
Capacity



B Rexel RSX1834 Shredder

- Shreds 18 sheets of 80gsm paper at a time into 4 x 40mm cross cut particles
- P-4 security level
- 34 litre bin
- Also shreds CDs, credit cards, staples and paper clips
- Features Jam Free technology for smoother operation
- Dimensions: W398 x D320 x H610mm

OR1834	each	£327.83
--------	------	---------

C



19
Sheet
Capacity

C Rexel RDX1850 Confetti Cut Shredder

- LED indicators illuminate to warn when there's too much paper
- Auto shut off after 2 minutes of non use
- Shreds staples, paperclips, credit cards & CDs
- Large 50 litre waste bin
- Shreds up to 19 sheets of 80gsm paper into 4 x 45mm particles
- Auto oiling system
- Security level 3
- 2 year warranty, 20 year cutter warranty

F06188	Shredder	each	£452.92
40070	Waste Bags	pk 100	£89.39

D



D Swordfish Heavy Duty 1500XCD Shredder

- 15 sheet shredder
- 30 litre waste bin holds approx. 230 sheets
- Auto reverse feature helps to prevent jams
- Accepts single credit card, CD or DVD
- Cuts paper into 4 x 25mm particles
- Security level 3

31106	each	£291.24
-------	------	---------



A Swordfish 1600XCD HD 16 Sheet Cross Cut Shredder

- Cuts an A4 sheet into approx. 400 pieces
- Shreds approx. 6500 sheets per hour
- Slide-out waste bin
- Shreds credit cards, DVDs, paperclips, & small staples
- Security rating DIN Level P-4 + O-3
- Recommended for highly sensitive data

31107 each £256.87



A

B Swordfish Heavy Duty 2000XCD Shredder

- 27 litre bin
- Multiple temperature indicators
- Auto-stop when bin full and auto-reverse on jamming
- Cuts an A4 sheet into approx. 625 pieces
- Shreds approx. 1,920 sheets per hour
- Slide-out waste bin
- Shreds credit cards, CDs/DVDs and staples
- 4 castors for easy mobility
- Security rating DIN P-4 + O-3

31108 each £329.66



B

20
Sheet
Capacity

C Rexel Auto+ 300X Hands Free Shredder

- Automatically shreds 250 sheets into 4 x 40mm confetti cut particles or 8 sheets via manual paper entry slot
- Large, 40 litre pull out waste bin
- Shreds credit cards & CDs (separate waste bin)
- Quiet operation (less than 60dBA)
- Security level 3
- 2 year warranty

30958 each £488.81

250
Sheet
Capacity



C

D Rexel Auto+ 600X Hands Free Shredder

- Automatically shreds up to 600 sheets (80gsm) or 660 sheets (70gsm) into P-4 (4 x 40mm) cross cut pieces
- No need to stand and feed it with paper, or even remove staples and paper clips.
- Conforms to DIN level P-4
- 600 sheet capacity*
- 4 x 40mm cross cut
- 230mm throat width
- 80 litre pull out bin
- Accepts staples, paper clips & credit cards
- Reliable roller based technology
- Door open/bin full & cool down indicator

30959 each £917.57



D

600
Sheet
Capacity



CALL US ON 01527 878348



VISIT WWW.FORWARDPRODUCTS.CO.UK

A



A Brother MFC-J5730DW All In One A3 Inkjet Printer

- First page out time of just 6 secs and a 50-page, 2-sided Auto Document Feeder and a 100-sheet multi-purpose tray
- 500-sheet capacity paper tray and a 100 sheet multipurpose tray for printing on a wide range of media
- Scan to cloud storage services directly from the large 9.3cm swipec touchscreen
- Print up to 22 page per minute (mono) & up to 20 page per minute (colour)
- Copy 12 images per minute (mono), 9 images per minute (colour), 600 x 600 dpi resolution, automatic 2 sided copying
- Scan speed of 14 Images per minute (mono & colour)
- Fax: 33.6K modem, automatic 2 sided faxing, send & receive directly from PC
- Includes starter Ink cartridges, power supply cable, fax line cable, driver software for Windows, Quick Set-Up Guide
- A3 wireless network ready multifunction fax copier printer & colour scanner
- 500 sheet capacity
- Up to 4,800 x 1,200dpi print resolution
- 9.3cm colour touchscreen LCD display
- 50 sheet ADF
- Duplex printing

MBIJ563 each £241.32

B



B Brother MFC-J5330DW Inkjet Fax / Printer Machine

- An all-in-one inkjet
- First page out time of a 6 seconds and a 50-sheet Automatic Document Feeder
- High yield inks with a life of up to 3,000 pages
- Scan to popular cloud apps directly from the large 6.8cm swipec touchscreen
- Print up to 22 page per minute mono & up to 20 page per minute colour
- Copy 12 images per minute (mono), 9 images per minute (colour), 600 x 600 dpi resolution, automatic 2 sided copying
- Colour & mono scanning up to 14 Images per minute (mono & colour)
- Fax: 14.4K modem, send & receive from PC
- Includes starter ink cartridges, power supply cable, fax line cable, driver software for Windows, Quick Set-Up Guide
- A4 wireless network ready multifunction fax copier printer & colour scanner
- A3 capability using extending tray
- 250 sheet capacity
- Up to 4,800 x 1,200dpi print resolution
- 6.8cm colour touchscreen LCD display
- 50 sheet ADF
- Duplex printing

MBIJ56 each £177.79



A Q Connect Keyboard

- Standard keyboard that is easy to use and reliable
- Tactile feel
- Keyboard size: 465 x 185 x 30mm
- Wired USB connection

F00779 each £12.27



A

B Kensington Wired Keyboard

- Spill-proof and built to last
- Sealed membrane design lets liquid from accidental spills run through without damaging keyboard electronics
- Plug & Play functionality
- 150cm USB cable
- USB or PS2 connection
- 5 year warranty

14014AC each £15.84



B

C Fellowes Lumbar Support

- Compact design for use on the move
- Supports back during extended periods of sitting
- High density foam promotes neutral posture
- Adjustable straps hold cushion in place
- Soft brushed cover can be removed for cleaning

52685 each £29.72



C

D Canon CanoScan LiDE 300 Photo & Document Scanner

Simple, high performance scanning.

- 2400 x 4800 dpi resolution
- 48 bit colour
- 4 EZ buttons for copy, scan, email & PDF
- Dust & scratch reduction
- Auto scan mode
- Z – Lid for thick document scans

MCASC120 each £74.95



D



A Desktop Copyholder Easel

- Ergonomic curve provides correct reading angle
- Non-glare, anti-static surface
- Spring loaded adjustable line guide can be mounted left or right
- Spring loaded, large capacity paperholder clip

F04521 each £10.92



B Monitor Riser Black/Clear

- Raises your screen to eye level to prevent neck strain
- Supports up to a 21" flat panel monitor or a weight of 10kgs
- 3 height adjustments

54138 each £29.64



C Laptop Riser

- Places your laptop at a comfortable viewing angle for ease of use
- Supporting front edge prevents laptop from sliding off riser
- Adjustable tilt allows you to customise your viewing angle
- Stacks on letter trays for a convenient space saving solution

47095 each £31.47

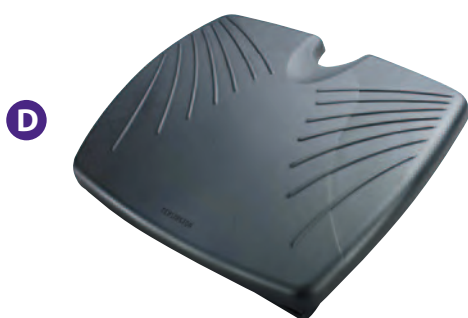

D Kensington Footrest

- Height angle adjustable positions to support your legs
- Comfortable and generous size footgrip
- Textured platform
- Cool graphite grey platform is tough and scratch resistant
- SpeedFix design offers quick and simple assembly
- Dimensions L450 x W350mm

56148 each £25.65



E Kensington Massage Footrest

- Adjustable footrest enables maximum comfort
- Height adjusts from 3" to 5"
- Tilt adjusts 30 degrees
- Elevates legs to prevent pressure on the thighs and facilitate good posture
- Unique surface designed to stimulate the nerve endings in the bottom of the foot
- Gentle rocking mechanism helps to improve circulation and resist fluid build up in the lower legs

56155 each £45.46



New charging solutions for iPads and tablets

Gratnell's Power Trolley

Safely store, charge and sync your USB devices in this compact trolley which holds the new Gratnell's PowerTrays. Comes in a choice of colours and will hold either three Deep PowerTrays or two Extra Deep PowerTrays

- Lockable
- Takes 3 Deep or 2 Extra Deep PowerTrays
- Compact and portable
- Bespoke door hinges offer 270 degrees opening angle
- Robust locking system
- Size: W423 x D545mm
- Height 790mm to top & 957mm incl. handle
- Choice of colours - Silver(SI), White(WH), Pink(PI), Blue(BL) or Yellow(YW) metal finish

GRATPT**	each	£282.67
----------	------	---------

** Please specify colour when ordering



Gratnells PowerTrays

Storage and charging in one handy Gratnells tray.

- Stores, charges and syncs up to ten USB devices in lightning fast speed using Dynamic Device Recognition
- Available in 2 sizes - deep and extra deep
- Compatible with all standard Gratnells storage units
- Firmware is updatable for future updates
- Recognises and analyses devices for intelligent charging
- Available in White(WH) or Silver(SI)

Deep

- H150 x W312 x L427mm

GPTDC	Charge	each	£227.81
-------	--------	------	---------

*Please specify tray colour

Extra Deep

- H225 x W312 x L430mm

GPTEDC	Charge	each	£257.57
--------	--------	------	---------

*Please specify tray colour



A



A CD's

- High capacity compact disks
- CD-R disks are recordable and have 700MB/80 minute capacity

CD-R

F00421	Spindle	pk 50	£11.11
--------	---------	-------	--------

B



B DVD's

- Ideal for anyone requiring data-intensive, high-performance data storage
- High-speed recording

DVD-R (Speed 16x)

21976	Jewel Case	pk 10	£7.52
21980	Spindle	pk 50	£16.28

C



C USB Flash Drives

- USB Flash Drive for Data Transfer & Back-up with a smart swivel case
- Cap swivels 360° to protect connector
- USB 2.0 connection for High Speed File Transfer
- Lanyard hole ensures portability
- Suitable for Windows & Mac

41511	4GB	each	£7.18
41512	8GB	each	£8.04
41513	16GB	each	£8.97
76970	32GB	each	£14.87



A Economy Mouse Mat

- 6mm foam base with non-slip backing
- Approx. 250 x 220mm
- Great for everyday use

F04516	Blue	each	£1.37
F04517	Black	each	£1.37



B Gel Mouse Pad & Wrist Rest

- Ergonomically designed for comfort and to reduce stress
- Cushioned support helps avoid strain
- Mouse pad has integrated wrist rest
- Non-skid base
- Made from Lycra to stretch & conform to the wrist

F02213	Mouse Pad	each	£13.15
F04520	Wrist-Rest	each	£18.34

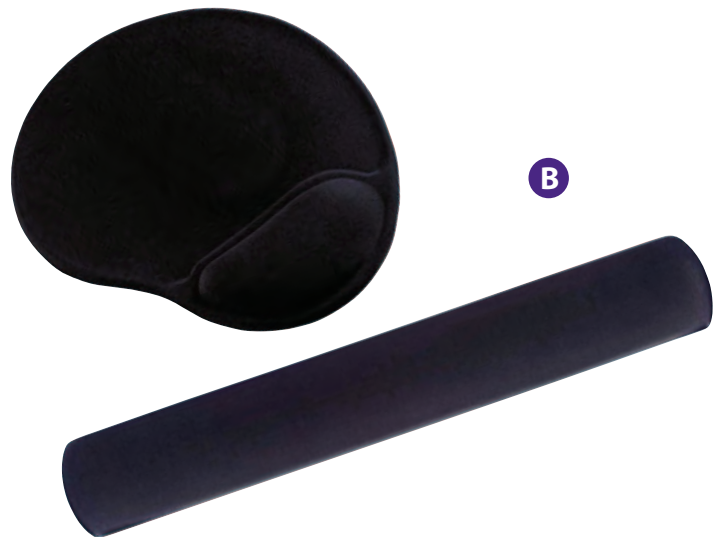

C Clear Gel Mouse Mats & Wrist Rests

- Provide added comfort and style
- With cord router to organise mouse cables
- Lift up PVC cover allows you to insert pictures etc.

Mouse Mats

20084	Grey	each	£12.61
20085	Blue	each	£12.61

Wrist Rests

20087	Black	each	£15.86
20088	Blue	each	£15.86



A



B



A Telephone & Multi-Purpose Cleaning Wipes

- Clean and sanitise your equipment
- Powerful formula removes office bugs from telephones and other equipment

F04508 pk 100 £3.18

B Air Duster

- Ozone friendly pressure duster to remove dust from hard to reach areas on equipment
- Perfect for keyboards, printers, cameras etc
- 400ml

F04499 each £5.12

C



C Surface Cleaners

- A range of cleaners to remove surface grime
- Anti static formulation on cleaning wipes and cleaning fluid
- Wipes will not dry out in handy resealable pull through tubs
- Foam cleaner restores the appearance of hardware
- Cleaning fluid contains bactericide - not to be used on portable equipment and touch screens

F04501 Screen & Keypad Wipes tub 100 £3.18

F04502 Screen & Keypad Fluid 250ml £2.99

F04504 Surface Foam Cleaner 400ml £3.82

D



D Desk Fans

- Three step speed controls
- Oscillating and tilting features

F00402 230mm (9") each £22.78

F00405 300mm (12") each £25.77

E



E Fan Heater

- 2 heat setting with adjustable thermostat
- Over heat protection
- 2kW heating power
- Can be used upright or flat

11112 each £20.94

F

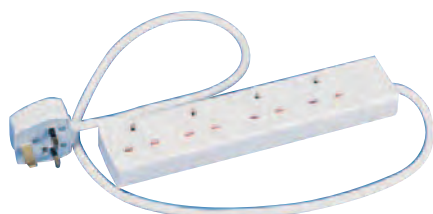

F Extension Leads

- Durable 13 amp extension leads
- Unobtrusive white style with 2 length options

11330 4 Gang 2m each £4.75

11331 4 Gang 5m each £9.27



06

ART & CRAFT

ART PAPERS & CARDS	183-189
DISPLAY PAPERS & BORDER ROLLS	190-195
TRACING PAPER	196
PAINTING & PRINTING	197-206
SKETCHBOOKS	207
WRITING, DRAWING & COLOURING	208-216
CRAFT & MODELLING	217-225
ADHESIVES	226-229



Paper & Card Thickness Guide

- Gsm = Grams per square metre - a measure of the weight of the paper and a general indication of its thickness and opacity.
- Microns = A specific measure of the thickness of the paper. 1 micron is 1/1000th of an inch.
- SHT or sheets is an old imperial measure of thickness.
- Because of the nature of paper manufacture, the conversion of weights to thickness is approximate and will vary between paper types and manufacturers.

FOR SUGAR PAPER ROLLS

SEE PAGE 193

A



B

C

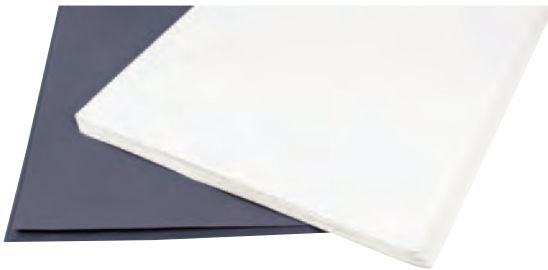

D



E



Paper & Card Thickness Guidelines			
GSM	Microns	Sheet	Usage
150	200	2 Sht	Thin card for general project work. Suitable for most printers and copiers.
175	230	3 Sht	Thin card for folding, modelling and montage
220	280	4 Sht	Medium/thin card for modelling, mobiles, projects etc.
280	340	6 Sht	Medium thickness for modelling and construction work.
560	750	12 Sht	Very thick card for mounting, framing and rigid modelling structures

A Assorted Sugar Play Paper

- Brightly coloured sugar paper in 100gsm for a multitude of uses
- Great for art and craft

SUGPA4A	A4	pk 250	£2.71
SUGPA3A	A3	pk 250	£5.62
SUGPA2A	A2	pk 250	£9.85
SUGPA1A	A1	pk 250	£18.93

B Black A1 Sugar Paper

- Ideal for backing drawings and displays

SUGPA1BK	pk 250	£19.53
----------	--------	--------

C A2 Sugar Paper - Single Colours

- Large format sheets ideal for display and pictures

SUGPA2BK	Black	pk 250	£10.31
SUGPA2WH	White	pk 250	£10.31

D White Cartridge Papers

- Quality white cartridge paper
- Ideal for pen, pencil and pastel work
- Choice of 2 popular sizes and weights

100gsm

DCPA3100	A3	pk 250	£6.98
DCPA4100	A4	pk 250	£3.55

140gsm

DCPA3130	A3	pk 250	£9.11
DCPA4130	A4	pk 250	£5.16

E Poster Paper Mounts

- A4 plus size gives 20mm border (250 x 337mm)
- Super value pack for mounting
- Assorted pack 100 sheets

PPMA4	pk 100	£4.75
-------	--------	-------



A Black Card

- 100% Recycled
- High quality matt black board
- Ideal for making models and mounts
- 3 weights available

230 micron - 3 sheet

BDBK230A4	A4	pk 100	£5.66
BDBK230A3	A3	pk 100	£9.40

340 micron - 6 sheet

BDBK340A4	A4	pk 100	£5.75
BDBK340A3	A3	pk 100	£10.36
BDBK340A2	A2	pk 100	£18.42

750 micron - 12 sheet

BDBK750A4	A4	pk 50	£10.45
-----------	----	-------	--------



RECYCLED
PRODUCT

RECYCLED
PRODUCT

A

FOR
PHOTOCOPIABLE
WHITE CARD

SEE PAGE 34

B White Card

- 100% Recycled
- Wide range of white board for variety of art & craft applications
- 3 weights available

230 micron - 3 sheet (181gsm)

BDW230A4	A4	pk 100	£3.60
BDW230A3	A3	pk 100	£7.99

280 micron - 4 sheet (220gsm)

BDW280A4	A4	pk 100	£4.84
BDW280A3	A3	pk 100	£7.98
BDW280A2	A2	pk 100	£15.17

360 micron (283gsm)

BDW360A4	A4	pk 100	£4.60
----------	----	--------	-------



RECYCLED
PRODUCT

RECYCLED
PRODUCT

B

FOR COLOURED
COPY PAPER

SEE PAGE 187

C Single Colour Card

- A4 300 micron - 6 sheet
- Medium thickness board with a super smooth surface
- Ideal for modelling, construction and mounts

BD340A4RD	Red	pk 50	£3.95
BD340A4GR	Green	pk 50	£3.95

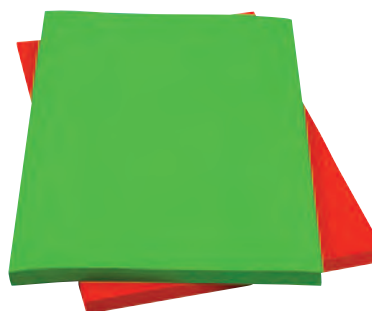

C



CALL US ON 01527 878348



VISIT WWW.FORWARDPRODUCTS.CO.UK



A Pastel 230 Micron Coloured Card

- 5 assorted pastel shades
- Ideal for art and craft

BDECOA4	A4	pk 200	£5.75
BDECO56	A2	pk 100	£12.12



B Vivid 230 Micron Coloured Card

- 5 assorted vivid shades
- Ideal for art and craft

BDVIVA4	A4	pk 200	£7.30
BDVIVA2	A2	pk 100	£16.13



C Bright 230 Micron Coloured Card

- 10 assorted bright shades
- Ideal for art and craft

BDTENA4	A4	pk 200	£5.96
BDTENA3	A3	pk 100	£6.56
BDTENA2	SRA2	pk 100	£12.67



D Intensive 230 Micron Coloured Card

- Superb, truly vibrant assortment of ten colours
- Ideal for art and craft

BDINTA4	A4	pk 200	£7.11
BDINTA2	SRA2	pk 100	£15.13

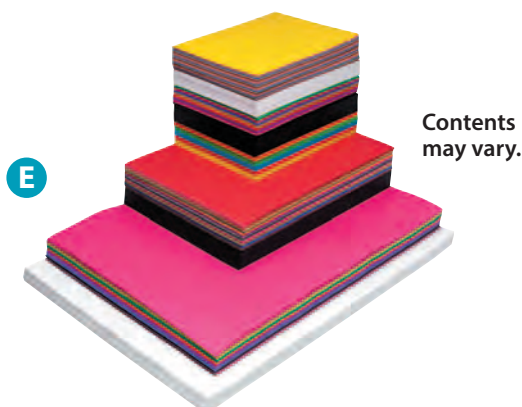

E Coloured Paper & Card Value Pack

- Value pack containing large assortment of papers for art lessons for all ages
- Average pack contents 25kg including:
 - Black card 340 micron
 - Coloured card various
 - White card
 - Dual board 200 micron
 - Play paper
- Sheet sizes A4 - A2

CPC25	each	£65.57
-------	------	--------



A Assorted Crepe Paper

- Superior quality crepe suitable for all types of art and craft work
- 12 assorted colours

CREPEA	500mm x 3m	pk 12	£4.42
--------	------------	-------	-------



B Colourfast Crepe Assortment

- Colourfast means the colour won't run when wet
- 50cm x 3m
- Pack of 25 two each of yellow, orange, light green, dark green, light pink, light blue, dark blue, purple, brown, black, white and red plus one other colour not specified (may vary from pack to pack)

CREP25A	Crepe Assorted	pk 25	£7.91
---------	----------------	-------	-------



C Tissue Paper Rolls

- These non-bleed tissue paper rolls offer superb value for money
- 24 Assorted rolls (48 sheets per roll)
- 2 rolls each of White, Red, Yellow, Apple Green, Dark Green and 1 roll each of: Blue, Violet, Old Gold, Black, Brown, Cerise, Orange, Lilac, Lt Blue, Lt Brown, Lt Pink, Turquoise, Pink & Lt Green
- Colours may vary
- Each sheet is 507 X 761 mm, 18gsm

7820		24 rolls	£51.37
------	--	----------	--------



D Tissue Paper Squares & Circles

- High quality tissue in range of bright colours
- Assorted colours

TISS10SQ	100mm Squares	pk 480	£1.98
TISS15SQ	150mm Squares	pk 480	£2.45
TISS10C	100mm Circles	pk 480	£2.08
TISS15C	150mm Circles	pk 480	£2.45



E Lustre Lites Tissue Paper

- Colourfast pastel tones
- 508 x 762mm
- Contains 2 sheets each of lime, aqua, lemon, tangerine, watermelon & periwinkle

TISS5896		pk 12	£3.47
----------	--	-------	-------



F Tissue Paper Bulk Packs

- Super value assorted squares or circles
- Classpack of 4600 No. 10cm tissue squares or circles

TISSQA	Squares	pk 4600	£9.20
TISSCA	Circles	pk 4600	£9.20



Kaskad Copier Paper & Card

RANGE GUIDE

Colour	A4 80 gsm	A4 120 gsm	A4 160 gsm	A3 80 gsm	A3 160 gsm
Pastel Colours					
Bunting Yellow	KK608055	KK619055	KK621055	KK608655	KK621655
Eider Vellum	KK608012	-	KK621012	KK608612	KK621612
Pintail Cream	KK608054	-	KK621054	KK608654	-
Leafbird Green	KK608065	KK619065	KK621065	KK608665	KK621665
Siskin Green	KK608061	-	KK621061	KK608661	-
Merlin Blue	KK608072	-	KK621072	KK608672	-
Puffin Blue	KK608075	KK619075	KK621075	KK608675	KK621675
Skylark Violet	KK608085	KK619085	KK621085	KK608685	KK621685
Flamingo Pink	KK608025	KK619025	KK621025	KK608625	KK621625
Salmon	KK608031	-	KK621031	KK608631	-
Curlew Cream	KK608013	KK619013	KK621013	KK608613	KK621613
Sparrow Grey	KK608093	-	KK621093	-	-
Wheatear Yellow	KK608053	-	KK621053	KK608653	-

Bright Colours

Oriole Gold	KK608056		KK621056	KK608656	-
Canary Yellow	KK608057	KK619057	KK621057	KK608657	KK621657
Barbet Green	KK608069	-	KK621069	KK608669	-
Warbler Green	KK608064	-	KK621064	KK608664	-
Peacock Blue	KK608077	-	KK621077	KK608677	KK621677
Swallow Blue	KK608088		KK621088	-	-
Plover Purple	KK608086	-	KK621086	KK608686	-
Hummingbird Amethyst	KK608087	-	KK621087	KK608687	-
Bullfinch Pink	KK608022	-	KK621022	KK608622	-
Lapwing Brown	KK608016	-	KK621016	-	-
Owl Grey	KK608094	-	KK621094	-	-

Deep Colours

Rosella Red	KK608029	-	KK621029		
Robin Red	KK608028	-	KK621028	KK608628	KK621628
Fantail Orange	KK608048	-	KK621048	KK608648	KK621648
Mandarin Orange	KK608059	-	KK621059	-	-
Goldcrest Yellow	KK608058	KK619058	KK621058	-	KK621658
Parakeet Green	KK608067		KK621067	KK608667	-
Woodpecker Green	KK608068	-	KK621068	KK608668	-
Mallard Green	KK608063	-	KK621063	KK608663	KK621663
Kingfisher Blue	KK608078	-	KK621078	KK608678	-
Nuthatch Brown	KK608019	-	KK621019	-	-
Raven Black†	KK608099	-	-	-	-

Brilliant Neon Tints

Cerise	KK608030	-	-	-	-
Lime Green	KK608060	-	-	-	-
Orange	KK608040	-	-	-	-
Yellow	KK608050	-	-	-	-

- The Kaskad range of coloured paper is probably the widest range of coloured paper in Europe
- Kaskad's superb selection of tasteful shades from pastel tints through to vibrant fluorescent colours are guaranteed to meet all your copying, laser printing, inkjet printing and fax paper requirements
- Most of the shades are available in a variety of weights and sizes.
- Kaskad's colourful range ensures maximum flexibility whatever the requirement

These colours are a printed guide only, to see the real thing call us for a free sample swatch.

* While stocks last
† Black not suitable for use in copiers or lasers

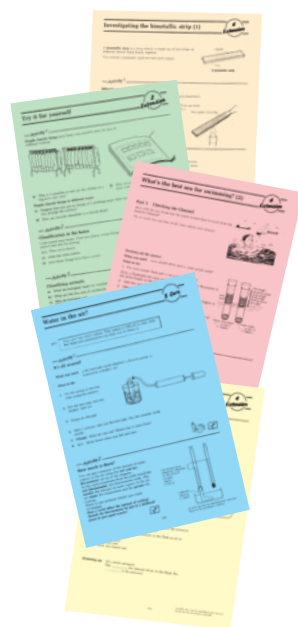

Did you know?

That using a colour like Eider Vellum can help children with reading difficulties such as Dyslexia "letters no longer jump around like they do on white paper"
Please speak to your SEN coordinator about running a trial



Kaskad Copier Paper & Card

- Guaranteed for laser printing, double-sided copying and mono inkjet printing
- Use for newsletters, reports, internal memos etc
- Environmentally friendly, Totally chlorine free (TCF)
- Plain paper fax? Use a colour to distinguish incoming faxes
- Would you like to see the colours? Phone now for a sample swatch

Description	Qty per pack	Pks per box	1-4	5+
A4 80gsm				
Pastel Tints (PT)	500	5	£5.20	£4.39
Bright Tints (BT)	500	5	£5.99	£4.99
Deep Tints (DT)	500	5	£6.29	£5.29
Brilliant Neon (BR)	500	5	£9.75	£8.59
Black (BK)	500	5	£12.70	£11.67

A3 80gsm

Pastel Tints (PT)	500	5	£10.09	n/a
Bright Tints (BT)	500	5	£10.79	n/a
Deep Tints (DT)	500	5	£11.65	n/a

A4 120gsm

Pastel Tints (PT)	250	5	£6.15	n/a
Bright Tints (BT)	250	5	£7.05	n/a
Deep Tints (DT)	250	5	£7.65	n/a

A4 160gsm Card

Pastel Tints (PT)	250	5	£6.09	£5.55
Bright Tints (BT)	250	5	£6.99	£5.85
Deep Tints (DT)	250	5	£7.29	£6.19
Nuthatch Brown KK621019	250	5	£12.35	£11.56

A3 160gsm Card

Pastel Tints (PT)	250	5	£14.95	n/a
Bright Tints (BT)	250	5	£15.99	n/a
Deep Tints (DT)	250	5	£16.99	n/a

Assorted Packs

KAS480PA	A4 80gsm	Pastel	1 x 500	£8.07	n/a
KAS480BA	A4 80gsm	Bright	1 x 500	£8.29	n/a
KAS480DA	A4 80gsm	Deep	1 x 500	£8.81	n/a
KAS160PA	A4 160gsm	Pastel	1 x 250	£8.47	n/a
KAS160BA	A4 160gsm	Bright	1 x 250	£9.08	n/a
KAS160DA	A4 160gsm	Deep	1 x 250	£9.53	n/a

Assorted Packs

The 160gsm assorted packs have 50 sheets of each colour and the 80gsm contain 100 sheets of each colour. The following colours are in each pack:

Pastel: Flamingo Pink, Bunting Yellow, Leafbird Green, Puffin Blue, Skylark Violet

Bright Tints: Bullfinch Pink, Oriole Gold, Barbet Green, Peacock Blue, Plover Purple

Deep Tints: Rosella Red, Fantail Orange, Goldcrest Yellow, Woodpecker Green, Kingfisher Blue.



ask for a
free swatch



FOR BLACK CARD

SEE PAGE 184

The prices on this page may vary during the life of this catalogue due to market fluctuations



CALL US ON 01527 878348



VISIT WWW.FORWARDPRODUCTS.CO.UK

A

Clouds

Brick



A Fadeless® Design Rolls

- Fade resistant display rolls
- Ideal for drama productions and friezes
- Available in 4 patterns
- 3.6m x 1218mm rolls

56468	Clouds	each	£6.55
56478	Brick	each	£6.55
56228	Night Sky	each	£6.55
56258	Tropical	each	£6.55

B



B Craft Papers Bundle

Packed with loads of different coloured papers, cards, wraps and tissue paper! This fantastically varied array of craft papers includes over 540 A3 & A4 sheets, including the following items:

- Colour paper and card, tissue, crepe and gloss papers
- Holographic, glitter, iridescent & printed cellophane wrap
- Metallic card (single side), holographic card, iridescent paper and card
- Printed card (double sided), Black card, White card, Fluorescent paper and card
- Fadeless paper, Art paper, Printed art paper (single side)
- Tracing paper
- Felt
- Corrugated card board
- Stickers, 2 patterns x 3 sheets

BCPPK	each	£60.94
-------	------	--------

C



C A4 Metallic Card

- 225gsm
- Available in bronze, gold and silver

MC002	Silver	pk 20	£2.90
MC001	Gold	pk 20	£2.90
MC0124	Bronze	pk 20	£2.90

D

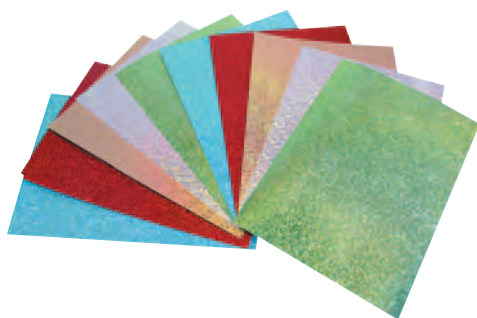

D A4 Holographic Card

- An assortment of different colours and designs of holographic card
- Ideal for card making and crafting
- Colours and designs may vary

HC7647	pk 10	£4.54
--------	-------	-------

E



E Metal Foil Paper Rolls

- 500mm x 4.5m rolls
- Assorted colours
- Ideal for greeting cards and display

MFR6AS	pk 6	£11.68
--------	------	--------



A Poster Paper Rolls

- Great for display and mounting
- Vibrant colours
- Plain on reverse
- 760mm x 10m rolls

PPRWH	White	each	£2.57
PPRLE	Lemon	each	£2.57
PPRRS	Rose	each	£2.57
PPRPG	Pale Green	each	£2.57
PPRLG	Leaf Green	each	£2.57
PPRUB	Ultra Blue	each	£2.57
PPRSC	Scarlet	each	£2.57
PPRBR	Brown	each	£2.57
PPROR	Orange	each	£2.57
PPRPK	Pink	each	£2.57
PPRPU	Purple	each	£2.57
PPREM	Emerald	each	£2.57
PPRTQ	Turquoise	each	£2.57
PPRSB	Sky Blue	each	£2.57
PPRBK	Black	each	£2.57
PPRSI	Silver	each	£2.57
PPRGD	Gold	each	£2.57
PPR10AS	Assorted	pk 10	£23.70

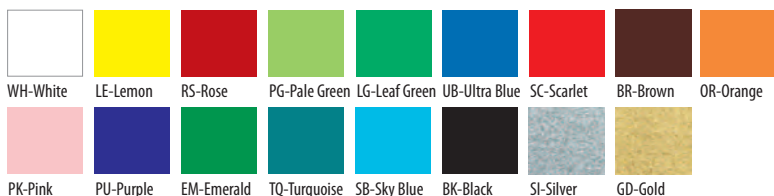

**FOR
BORDER ROLLS**
SEE PAGES 193-195



A

B Jumbo Poster Paper Rolls

- Large 50m rolls
- Fantastic for school displays
- Vibrant colours
- 760mm x 50m rolls

PPJRLLE	Lemon	each	£12.31
PPJRLG	Leaf Green	each	£12.31
PPJRUB	Ultra Blue	each	£12.31
PPJRSC	Scarlet	each	£12.31
PPJRBR	Brown	each	£12.31
PPJROR	Orange	each	£12.31
PPJREM	Emerald	each	£12.31
PPJRTO	Turquoise	each	£12.31
PPJRBK	Black	each	£12.31



B

C Poster Paper Sheets

- 20" x 30" (510 x 760mm)
- 95gsm paper

PPSA	Assorted	pk 100	£17.61
------	----------	--------	--------



C



A

A Fadeless Extra Wide Display Rolls

- 1218mm extra wide roll to cover walls quickly
- Vibrant colours resistant to sunlight fading
- Quality 85gsm thickness
- Coloured rolls 15m, metallic gold rolls are 7.5m

FR1218AG	Apple Green	each	£13.88
FR1218AZ	Azure	each	£13.88
FR1218BK	Black	each	£13.88
FR1218BB	Bright Blue	each	£13.88
FR1218BR	Brown	each	£13.88
FR1218CA	Canary	each	£13.88
FR1218EM	Emerald	each	£13.88
FR1218FL	Flame	each	£13.88
FR1218MG	Magenta	each	£13.88
FR1218MA	Maroon	each	£13.88
FR1218GD	Metallic Gold	each	£13.88
FR1218NG	Nile Green	each	£13.88
FR1218OG	Old Gold	each	£13.88
FR1218OR	Orange	each	£13.88
FR1218RBL	Rich Blue	each	£13.88
FR1218RYB	Royal Blue	each	£13.88
FR1218SB	Sky Blue	each	£13.88
FR1218SY	Sun Yellow	each	£13.88
FR1218TE	Teal	each	£13.88
FR1218VI	Violet	each	£13.88

B



B Fadeless Display Roll Bulk Pack

- 609mm x 3.6m rolls in 10 colours: white, canary, orange, apple green, purple, azure blue, violet, flame red, pink and black
- Box of 48 rolls
- Good quality 85gsm thickness

FRD57559 pk 48 £115.26

C



C Fadeless Extra Wide Display Roll Bulk Pack

- 1218mm x 3.6m rolls in 8 assorted colours: canary, flame red, black, orange, pink, azure, violet & emerald
- Quality 85gsm thickness
- Box of 24 rolls

FRD57520 pk 24 £115.26

D



D Scalloped Fadeless Corrugated Borders Bulk Box

- 36 Bordette border rolls in a neat and easily accessible dispenser box
- 57mm x 7.5m
- 6 rolls of each colour: flame, canary, emerald, rich blue, bright blue and black

CWB37950 pk 36 £94.47



A Fadeless Display Pack - Spring Colours

- Co-ordinated Fadeless display rolls and corrugated border rolls in spring colours
- Contains one 1218mm x 15m roll each of Canary, Nile Green, Pink and Sky Blue
- Contains 3 bordette rolls of each of Canary, Nile Green, Pink and Sky Blue

57456 each £92.07



A

B Fadeless Display Pack - Standard Assortment

- A superb combination of four 1218 x 15m fadeless rolls plus 12 rolls of bordette border trim
- Fadeless rolls: Flame, canary, emerald and bright blue
- Bordette: 2 rolls each of flame, canary, emerald, bright blue, black and white

CDP5749 each £92.07



B

C Fadeless Display Pack - Cool Blue

- Co-ordinated Fadeless display rolls and corrugated border rolls in cool blue colours
- Contains one 1218mm x 15m roll each of Bright Blue, Azure, Royal Blue and Sky Blue
- Contains 3 bordette rolls of each of Bright Blue, Azure, Royal Blue and Sky Blue

57455 each £92.07

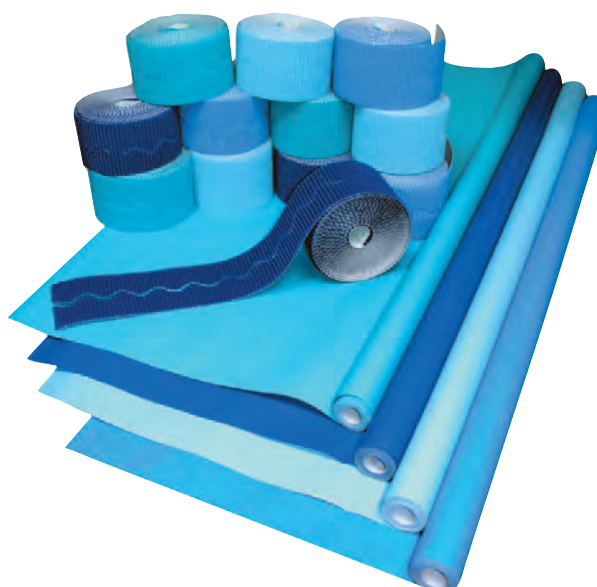

C



A



A Sugar Paper Rolls

- Ideal for use in the classroom
- 508mm x 10m roll
- Assorted pack of 5 rolls

FR50810AS

pk 5 £13.04

B



B Scalloped Fadeless Corrugated Border Rolls

- Scalloped edge corrugated rolls available in bright colours
- 15m x 57mm
- Ideal for classroom displays

CWB15FR	Flame	each	£2.97
CWB15BB	Bright Blue	each	£2.97
CWB15EM	Emerald	each	£2.97
CWB15NG	Nile Green	each	£2.97
CWB15CA	Canary	each	£2.97
CWB15WH	White	each	£2.97
CWB15BK	Black	each	£2.97
CWB15VI	Violet	each	£2.97
CWB15RBL	Rich Blue	each	£2.97
CWB15AZ	Azure	each	£2.97
CWB15MG	Magenta	each	£2.97
CWB15AG	Apple Green	each	£2.97
CWB15OR	Orange	each	£2.97

C



C Bordette Bumper Assortment

- Corrugated border trim with a wavy edge in 12 assorted colours
- 57mm x 15m
- Pack of 12 rolls, one each of: Flame Red, Orange, Canary Yellow, Bright Blue, Royal Blue, Violet, Emerald Green, Nile Green, Magenta, Brown, Black and White

37002

pk 12 £35.60

D



D Fadeless Bulletin Scalloped Border Rolls

- Fade resistant colours
- Smooth finish, scalloped edge border rolls
- Ideal for bulletin boards, signs, room decoration
- 15m x 57mm rolls

BBMSI	Silver	each	£4.02
BBMGD	Gold	each	£4.02
BB6AS	Assorted	pk 6	£17.62



A Corrugated Wavy Border Rolls

- These wavy edged corrugated borders are the best selling border rolls adding a smooth but distinctive line to your displays
- Supplied in brightly coloured assorted packs
- Each roll 63mm x 10m

BR209W	pk 5	£8.67
BR209BP	pk 20	£36.17



A

B Corrugated Zig Zag Border Rolls

- Use these shaped corrugated borders to add an exciting, crisp finish to your displays
- Brightly coloured assorted packs
- Each roll 63mm x 10m

BR209P	pk 5	£11.18
--------	------	--------



B

C Metallic Corrugated Border Rolls

- Brightly coloured assorted metallic packs
- Each roll 63mm x 10m
- Great for party displays

BRM209W	Wavy	pk 5	£12.91
---------	------	------	--------

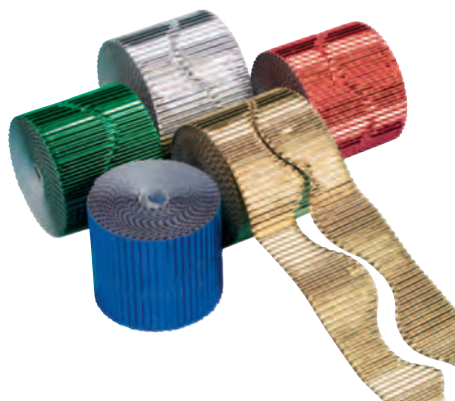

C

D Warm Scalloped Fadeless Corrugated Border Rolls

- Selection of 6 warm colours of bordette rolls
- 1 each of flame red, canary, black, orange, violet and metallic gold

CWBWM6	pk 6	£16.88
--------	------	--------



D

E Cool Scalloped Fadeless Corrugated Border Rolls

- Selection of 6 cool colours of bordette rolls
- 1 each of emerald, bright blue, rich blue, Nile green, azure and white

CWBCL6	pk 6	£16.88
--------	------	--------



E

A



A Poster Paper Border Rolls

- Vivid colour rolls for economical displays
- 48mm x 50m rolls

BR6A	Assorted	pk 6	£13.36
BR6BK	Black	pk 6	£13.22

B

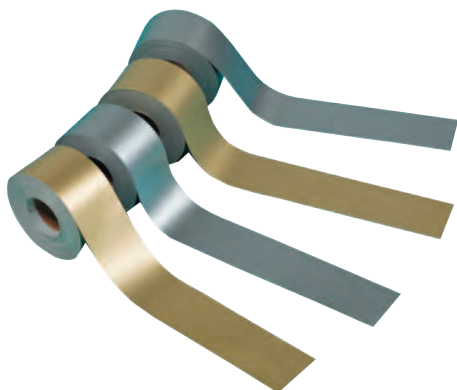

B Metallic Border Rolls

- Add lustre to seasonal or special displays
- 48mm x 50m rolls
- Pack 4 (2 each of gold and silver)

BR4A		pk 4	£14.09
------	--	------	--------



C



C Scalloped Border Rolls

- Pre-cut scallops ideal for framing
- 57mm x 50m x 2 (100m in total)

SBRRD	Red	each	£6.02
SBRYW	Yellow	each	£6.02
SBRBL	Blue	each	£6.02
SBRGR	Green	each	£6.02
SBRPR	Purple	each	£6.02
SBRBK	Black	each	£6.02

D

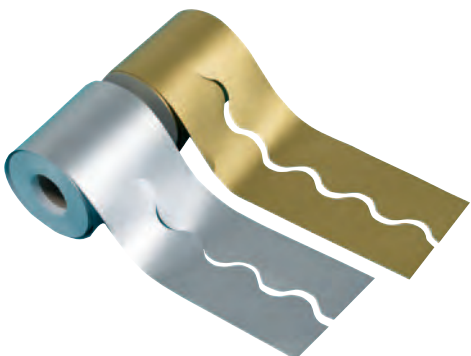

D Metallic Scalloped Border Rolls

- Pre-cut scallops ideal for framing
- 57mm x 50m x 2 (100m in total)

SBRMGD	Gold	each	£7.14
SBRMSV	Silver	each	£7.14



A Bleached Greaseproof Tracing Paper

- Consistent transparent tracing suitable for ink and pencil
- A4 38gsm

GTA434	pk 500	£7.86
--------	--------	-------



A

B Premium Tracing Paper

- Excellent quality paper for all types of tracing work
- 63gsm

TP63A3	A3	pk 250	£30.96
TP63A4	A4	pk 500	£21.54



B

C A4 Cellophane Sheets

- Perfect for lantern making, this pack contains 48 translucent coloured film sheets.
- 8 sheets each of 6 colours

73391	pk 48	£2.21
-------	-------	-------

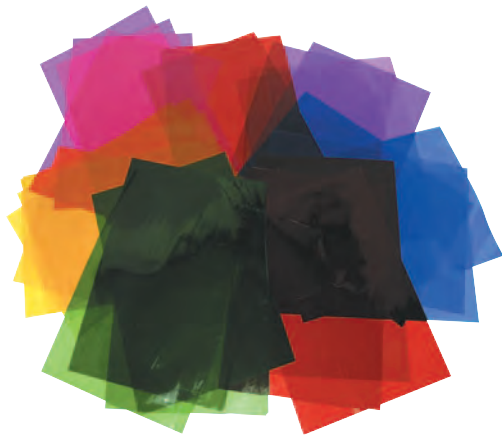

C

D Speech Balloon Display Accents

- Makes displays fun
- Delivers fun messages
- Builds student confidence
- 6 Designs , 6 of each - total 36 accents
- Each piece is 140mm tall

T10928	pk 36	£8.34
--------	-------	-------



D



Made in the UK



Our ready mix paint is a ready to use water based liquid poster paint. This top grade liquid tempera paint is rich and vibrant, has a thick texture with good coverage, making it a real pleasure to use. It is fully inter-mixable and dries into an opaque finish. Our ready mix paint can be easily diluted with water or mixed with Black Label or Red Label PVA glue to achieve thicker and glossier finishes.

Features

- Rich colour with a smooth, creamy consistency
- Super-clear packaging with flip-top cap
- Wheat and gluten free
- Available in a vast range of solid standard colours

Benefits

- Easy to work with, good opacity, pleasure to use
- Vivid colour in the bottle. Convenient dispensing
- Huge colour choice
- Safe for children

6 x 600ml Assorted Set Ready Mixed Paints

(Black, White, Brilliant Blue, Brilliant Red, Brilliant Yellow, Brilliant Green)

20 x 600ml Assorted Set Ready Mixed Paints

(2 Black, 4 White, 2 Brill Blue, 2 Brill Red, 2 Brill Yellow, Brill Green, Orange, Purple, Burnt Umber, Leaf Green, Sky Blue, Lemon & Crimson)

RMP6006 pk 6 £7.72

RMP60020 pk 20 £20.99





A Ready Mixed Paints

- Quality ready mixed tempera paint for strong opaque colour
- Handy 600ml squeeze bottles in 16 colours

RMP600BK	Black	each	£0.92
RMP600BB	Brilliant Blue	each	£0.92
RMP600BG	Brilliant Green	each	£0.92
RMP600BR	Brilliant Red	each	£0.92
RMP600BY	Brilliant Yellow	each	£0.92
RMP600BS	Burnt Sienna	each	£0.92
RMP600BU	Burnt Umber	each	£0.92
RMP600CE	Magenta	each	£0.92
RMP600LGN	Leaf Green	each	£0.92
RMP600CB	Cobalt Blue	each	£0.92
RMP600OR	Orange	each	£0.92
RMP600PR	Purple	each	£0.92
RMP600SBI	Sky Blue	each	£0.92
RMP600TQ	Turquoise	each	£0.92
RMP600YO	Yellow Ochre	each	£0.92
RMP600WH	White	each	£0.92

A



FOR PAINT BRUSHES
SEE PAGES 203-204

BK Black	BB-Brill Blue	BG-Brill Green	BR-Brill Red	BY-Brill Yellow	BS-Burnt Sienna
BU-Burnt Umber	CE-Magenta	CB-Cobalt Blue	OR-Orange	YO-Yellow Ochre	LG-Leaf Green
PR-Purple	WH-White	SB-Sky Blue	TQ-Turquoise		

B 5 Litre Ready Mix Paints

- Quality ready mixed tempera paint for strong opaque colour

RMP5LBK	Black	each	£6.60
RMP5LBB	Brilliant Blue	each	£6.60
RMP5LBG	Brilliant Green	each	£6.60
RMP5LBR	Brilliant Red	each	£6.60
RMP5LBY	Brilliant Yellow	each	£6.60
RMP5LWH	White	each	£6.60

B



C Dispensing Pump for 5Lt Glue/Paint

- Strong plastic dispensing pump
- Less mess than pouring straight from the bottle

DP5LT	each	£2.99
-------	------	-------



NEW!

C

A



A Skin Tone Ready Mixed Paints

- Range of 6 paints to create real skin colours
- 500ml bottles
- Pack 6 assorted: black, white, peach, yellow ochre, burnt umber & burnt sienna

RMPST * pk 6 £5.61

* While stocks last

B



B Fluorescent Ready Mix Paints

- Range of 6 fluorescent paints
- 600ml bottles
- Pack of 6 assorted: yellow, orange, pink, red, blue & green

RV1274 pk 6 £14.57

FOR PALETTES

SEE PAGE 202

C



C Pearlescent Paint Assortment

- Ready and convenient to use water based liquid poster paint, which dries to give an attractive pearly lustre
- This top grade liquid tempera delivers a soft and subtle colour palette, and has a thick texture with good coverage making it a real pleasure to use
- It is fully inter-mixable and dries into a stunning coloured pearl finish
- This Ready Mixed Paint can be easily diluted with water or mixed with Black Label or Red Label PVA medium to achieve thicker results
- Pack of 6 colours: Blue, Red, Yellow, Green, Pink, Violet
- 300ml bottles with squeeze tops

PP3006AS pk 6 £13.58

NEW!

D



D Acrylic Paint Set 500ml Assorted

- Made using only pure acrylic resin
- Fantastically thick creamy consistency which allows easy use of a palette knife for impasto work
- It retains brush stokes and facilitates colour mixing and blending
- It can be thinned down for water colour techniques, staining and dry brush work
- Good open time and a semi-gloss finish

ACPS10 pk 10 £27.34



A Watercolour Tablet

- Excellent quality, 12 colour tablet set for all ages
- Supplied in a durable metal tin
- Great for class and field trips

WCT each £1.85



A

B 24 Watercolour Tablet Set

- Excellent quality, 24 colour tablet set for all ages
- Supplied in a durable metal tin

AWCT24 each £3.83



B

C Glass Paint Assortment

- A water based transparent paint for stained glass window effect on glass, plastic or foil
- Assorted pack 8 x 50ml

GLASSP pk 8 £10.97



C

D Marbling Ink

- Add a few drops to water and immerse paper or objects for stunning effects
- Pack of 6 x 25ml
- Assorted colours

MARINK pk 6 £5.85



D

E Chubbie Paint Markers

- Easy to use for small hands and much cleaner than a conventional brush
- Can be used on any porous surface: paper, card and fabric
- Quick drying and totally washable
- Pack of 8 x 75ml assorted colours

CPM75 pk 8 £8.27



E

A



A Block Printing Inks

- Water based inks suitable for lino, potato and stick painting techniques
- The chemical formulation is designed to optimize the transfer properties and the drying time - giving sufficient working time and the best possible opacity
- Supplied in 300ml tubes

BP300WH	White	each	£2.33
BP300YW	Yellow	each	£2.33
BP300BK	Black	each	£2.33
BP300RD	Red	each	£2.33
BP300BL	Blue	each	£2.33

B

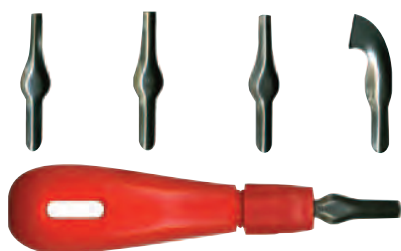

B Lino Cutter Set

- Cutter handle and set of 5 assorted cutters
- Handle has adjustable chuck for secure grip

MB792	each	£3.16
-------	------	-------

C



C Polymer Blocks

- Double sided polymer sheets for easy carving
- Approx 3mm x 150 x 200mm
- Will not distort under pressure or crumble
- Supplied in a pack of 10 sheets

MB791	pk 10	£11.60
-------	-------	--------

D



D Safeprint Foam Sheets

- A safer alternative to polymer sheets or traditional lino
- Ideal for making impressions of blunt objects and for general model making
- Can be cut, scored and folded
- 3mm thick

DT0036	A4	pk 25	£8.55
--------	----	-------	-------

E



E Inking Tray

- A simple 25cm x 20cm light, flexible inking tray for ink rollers and sponge rollers
- Also suitable for paint

MB7001	each	£2.10
--------	------	-------



A Non-Spill Paint Pots

- A paint pot designed to not spill its contents if knocked over
- Removable lid
- 90 x 70mm diameter

NSPOT pk 10 £5.76



A

B Large Non-Spill Waterpot

- A super stable waterpot with a wide 11cm base
- Ideal for holding water, paint, pens, pencils and brushes
- Accept standard lids and stoppers

ALSWPS pk 4 £4.46



B

C 6 Pot Paintpot Tray

- 6 small pots fitted into a 17cm x 12cm plastic tray
- Perfect for storage of small items such as sequins or beads as well as paints

MB7026 each £1.47



C

D 6 Well Paint Palette

- Holds size 2 colour blocks
- Also ideal for readymix and other paints as well as sharing small quantities of sequins, beads, glitter etc.

PAL6S each £0.57

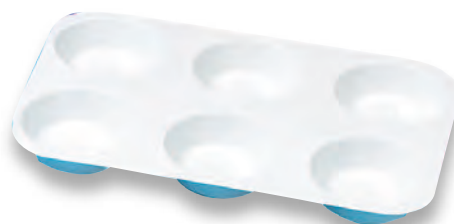

D

E 6-Well Block Holder Palette With Blocks

- A light, durable palette for use with junior and senior paint-blocks
- Also used for mixing paint
- Grooved centre for brush-storage
- 22cm x 16cm, with 58mm diameter wells

APWTCB each £2.84



E

F Finger Bowls

- A set of 4 plastic bowls in assorted colours
- Ideal for mixing/holding paint and for picking sequins/beads etc.
- 13cm diameter, 3cm depth
- Bowls stack for storage

FB2535 pk 4 £2.31



F

REDUCED
50%
 OFF
 TO CLEAR

A

B

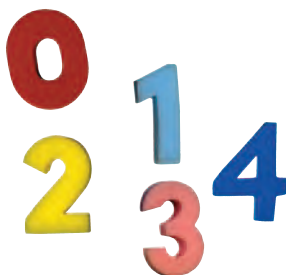
C

D

E

F

G

A A4 PVC Painting Sheets

- Transparent PVC sheet ideal for use with glass paints
- Thickness 0.4mm
- Easily cut with scissors or craft knife

PVC3127* pk 10 £2.36

* While Stocks Last

B Mini Dabbers

- 12 foam dabbers mounted in a plastic cup
- Overall length 7cm, dia. 3.5cm
- Domed foam head to produce a variety of effects and excellent water retention

AMFDPK set 12 £3.94

C Foam Number Shapes

- Assorted colour foam numbers 0 - 9, each approx 6cm tall and 2.5cm thick
- Fine foam for excellent water retention
- Colours may vary

FL3010 pk 10 £1.39

D Paint Scrapers

- Assorted set of 4 plastic paint scrapers to create different effects in thickly applied paint or sand.

APSSSET pk 4 £1.72

E Junior Painting Set

A fantastic value art set comprising:

- 32 Mixing pots
- 4 Pot storage trays
- 5 Roller trays
- 5 Six-well palettes
- 10 Size 8 hog hair brushes
- 10 Size 10 hog hair brushes
- 10 Size 12 hog hair brushes
- 9 assorted size paint dabbers (3 each small medium and large)
- 12 assorted pattern foam rollers

JPS500 each £28.97

F Chubby Short Handle Brushes

- Set of 4 natural bristle brushes with brightly coloured short chubby handles
- Overall length 9cm
- Easy to grip - ideal for small hands
- Also useful for special needs classrooms

ACHSBR set 4 £3.44

G Jumbo Non-Roll Brushes

- Short, sturdy, chubby handle designed for easy grip
- Non-roll shape ensures that brush will not roll off table
- Ideal for young children & special needs

MB6000 pk 10 £5.23



A Short Handle Round Hog Bristle Brushes

- Wooden handles
- Length between 170-220mm depending on size
- Available in an assorted pack of 100 brushes containing 20 of size 4; 15 each of sizes 6, 8, 10 and 12; 10 of size 14 and 5 of sizes 16 and 18

HHSR100 Assorted pk 100 £20.02



A

B Short Hogs Hair Brushes

- Short wooden handles and round tips
- 6 assorted sizes
- Suitable for everyday art and craft

HHBS6A pk 6 £2.36



B

C Starter Brush Set

- A terrific set of 25 brushes in a variety of shapes and sizes from small to large, bristles to foam

ASBSET set 25 £5.37



C

D Short Hogs Hair Round Brushes

- Pack 30
- Colours may vary
- 10 each of sizes 8, 10 and 14
- Approx. overall lengths 18.5cm - 21.5cm

HHRB30 pk 30 £8.73



D

E Golden Nylon Soft Brushes

- Suitable for use with most types of paint, but particularly with acrylic and PVA
- Robust & hard wearing, they provide an alternative to the hog bristle products for those who prefer using brushes with a non-animal origin
- Approx. overall length 17.5cm - 21cm
- Round tips
- 10 each of sizes 8, 12 and 18

GNSB30 pk 30 £18.79



E

F Long Hogs Hair Brushes

- Long wooden coloured handles
- Available with round or flat tips

10 each of sizes 4, 6, 8, 10, 14, 18

HHLF60 Flat Tips pk 60 £16.98

10 each of sizes 8, 12, 18

HHLR30 Round Tips pk 30 £10.45



F

A



A Assorted Foam Rollers

- 6 foam rollers, each 7cm in width
- Contains 1 smooth roller, 1 crinkle roller, 1 slotted roller & 3 assorted wave pattern rollers
- Inner roller glued to foam to prevent slipping

AFRPATT pk 6 £4.05

B



B Stretched Canvas

- Primed and stretched 100% cotton canvas
- Ideal for both oil and acrylic painting
- No side tack means that the side of the canvas is left smooth for hanging

AMSC66	6" x 6"	each	£1.32
ASC1012	10" x 12" (25 x 30cm)	each	£2.09

C



C Nylon Play Aprons Blue

- Polyurethane coated
- Waterproof
- Half length sleeves
- Elasticated cuffs
- Velcro back fastening
- Hand-wash only (do not tumble-dry)

	Size		
BPLAY60	60cm	each	£3.73
BPLAY70	70cm	each	£3.73

D



D Nylon Play Aprons Red

- Polyurethane coated
- Waterproof
- Half length sleeves
- Elasticated cuffs
- Velcro back fastening
- Hand-wash only (do not tumble-dry)

	Size		
RPLAY60	60cm	each	£3.73
RPLAY70	70cm	each	£3.73

E



E Plastic Table Cover

- Size 1500 x 1500 mm
- Blue pattern as shown
- Great for tables, under easels and floor
- Ideal for all art and craft

TCOVBL Splashmat each £3.25



A Double Sided Drying Racks

- Table top or floor standing
- Racks can be easily removed to create more space
- W800 x D505mm

1164C	20 Tray, 377mm High	each	£54.31
1165C	40 Tray, 620mm High	each	£86.60



A

B Mobile 40 Tray Drying Racks

- These large (up to A2 size paper) and small (up to A3 size paper) drying racks are ideal for moving around or between classrooms
- Lockable plastic castors
- Plastic coated easy clean coating
- Large W84 x D50 x H107cm
- Small W67 x D40 x H107cm

MDR1264	40 Tray Small (A3)	each	£104.07
MDR1265	40 Tray Large (A2)	each	£128.86

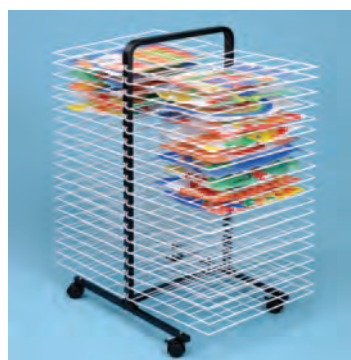

B

C Spring Loaded Drying Racks

- These drip-free paint dryers are made from top quality steel and feature spring loaded racks and separator bars
- The individual backs are manufactured from a fine wire to provide a flatter drip free dry
- Suitable to A2 size paper

SLDR10	10 Shelf	each	£73.59
SLDR20	20 Shelf	each	£107.93
SLDR30	30 Shelf	each	£168.73



C

D Big Book Bags

- Clear heavy gauge polythene bags with a 196mm handle and hook for hanging, storing and carrying books and other materials
- Available in 2 sizes

S40099	450 x 610mm	pk 10	£12.62
--------	-------------	-------	--------



D

E Polyholdalls

- Heavy duty polythene holdalls with handles

PHA3	A3	pk 10	£20.69
PHA1	A1	pk 10	£40.60



E

A

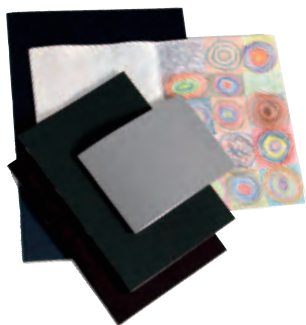

A A4 Starter Sketch Book

- Excellent general purpose book at a very economical price
- 40 pages of 100gsm quality acid free drawing cartridge
- 280 micron thick black covers

EA4SSB	pk 100	£59.95
--------	--------	--------

B



B Laminated Sketch Books

- Manufactured with a 380 micron laminated cover for extra durability
- 40 pages of 140gsm quality acid free drawing cartridge paper
- Standard colour black
- Other colours available when ordering large quantities (Blue, Burgundy and Green)

ELSBA4	A4	pk 40	£34.99
--------	----	-------	--------

C



C Traditional Spiral Sketch Books

- High quality sketchbooks suitable for all mediums
- 30 sheets of 100gsm acid free drawing cartridge paper
- 280 micron black cover

ETSBA4	A4	each	£2.79
ETSBA3	A3	each	£4.29

D



D Soft Cover Spiral Bound Sketch Books

- Smart sketch book with durable black laminated covers
- 50 pages of 140gsm acid free drawing cartridge paper
- Give your pupils a sense of pride in their sketches

ESBKA4	A4	each	£3.29
--------	----	------	-------

E



E Premium Hard Backed Sketch Books

- Superior quality hand made sketch books
- 380-micron Linen effect black covers
- 96 sheets of 140gsm all media cartridge paper

EPSBA4	A4	each	£4.89
EPSBA3	A3	each	£11.78



A Giant Coloured Chalks

- Perfect for use in the playground or indoors
- Easy for young hands to manage and to obtain maximum coverage quickly.

GCH01 tub 20 £3.55



A

B Anti-Dust Chalk

- Box of 144 white sticks
- Handy pack sizes

54404 White pk 144 £5.93



B

C Chunky Chalks

- Assorted coloured chunky chalks
- Size: 60mm long x 14mm diameter

CK5714AS Assorted pk 40 £3.75



C

D Plastix Crayons

- Hexagonal crayons can be sharpened like a pencil or use the flat side for large area colouring
- Thinner than the Chubbi Stump wax crayons, these Plastix crayons are a step up for slightly older children before they move on to 'proper' colouring pencils, and felt tips
- Assorted colours

PLASTIX12 pk 12 £1.71
 PLASTIX300 pk 300 £23.68



D

A



A Crayola Wax Crayons

- Quality wax crayons
- Handy pack sizes

SWC8	24 x pk 8	pk 192	£32.44
------	-----------	--------	--------

B



B Chubbi Stumps

- Long lasting, very hard to break wax crayons
- 57mm x 14mm
- These ever popular crayons have no paper wraps making them easier for young children to use (without asking for help to peel the paper off) and creating less mess!
- Assorted colours

CHUBBI40	pk 40	£3.29
CHUBBI288	pk 288	£18.95

C



C Chublet Wax Crayons

The same shape & wax formulation as Chubbi Stumps but smaller.

- Each crayon is 57 x 10mm and unwrapped
- 12 assorted colours

CHLET96	box 96	£4.72
---------	--------	-------

D



D Metallic Crayons

- Gold, silver & bronze assortment
- Ideal for black card and paper
- Great for brass rubbing

SCOMET12	pk 12	£2.87
----------	-------	-------



A Skin Tone Crayons

- A soft wax crayon in multi-cultural skin tones.
- 8 assorted colours

PSTW8 pk 8 £3.29



A

B Oil Pastels

- Ideal introductory set of oil pastels in 12 strong colours
- Easy to blend and highly opaque for vivid mark making
- Approx. 1cm diameter, length 7cm

AOPASS pk 12 £1.61



B

C Cray-Pas Expressionist Jumbo Oil Pastels

- Soft textured extra fine oil pastels
- Ideal for blending and shading
- Assorted colours

CPEX12 pk 12 £3.44



C

D Willow Charcoal

- Quality willow charcoal
- Medium thickness
- Great for sketching

PHCM25 pk 25 £3.55



D



A Swash Triangular Barrel HB Pencils

- High quality triangular shaped HB pencils, specially formulated to provide excellent writing, sketching and shading properties
- Chunky size is ideal for younger children or those with learning difficulties
- Strong, break resistant leads makes them ideal for school use

SWJP12 pk 12 £4.12



B

B Staedtler Noris Club Triplus Jumbo Triangular HB Pencil

- Learner's pencil in jumbo ergonomic triangular shape for easy grip
- Ideal for first writing and drawing exercises
- Break-resistant, super bonded, special lead formulation
- Wood from certified, sustainably managed forests

119T48 pk 48 £27.18



C

C Lyra Ferby Triangular Barrel Jumbo Graphite Pencils

- The famous 'Ferby' - chunky, broad pencils for younger children
- A half length graphite pencil in a natural wood finish
- Jumbo triangular grip for easy handling
- Supplied in handy re-usable tubs

971C36 pk 36 £18.54



D

D Stabilo Easy Graph Triangular Barrel Pencils

- HB pencils with triangular barrels and unique non-slip moulds
- Available in right and left hand versions or a mixed classpack with 42 right handed and 6 left handed pencils

ST321LH	Left Hand	pk 6	£5.86
ST321RH	Right Hand	pk 12	£10.95



E

E Staedtler Tradition 110 Pencils

- Popular school pencils
- Jet-bonding makes for greater strength, break resistance, and slow wear
- Made from Californian Cedar Wood
- Great for art & craft

10496	HB	pk 12	£4.63
10495	B	pk 12	£4.60
10494	2B	pk 12	£5.47
10492	4B	pk 12	£4.35



A Eziglide Premium HB Pencils

- Superb quality writing, drawing and sketching HB school pencils
- Quality alternative to Staedtler
- Excellent for all types of children's handwriting needs with break-resistant and super-bonded HB leads

FEHS12	pk 12	£1.26
FEHS150	pk 150	£10.59
FEHS600	pk 600	£41.33
FEHS1500	pk 1500	£95.39

SWITCH & SAVE



B Classroom HB Pencils

- High quality HB classroom pencils, suitable for writing and drawing
- Tough construction for fewer breakages, and less time spent sharpening!
- Rigorously tested to ensure your pupils are using the best quality pencils
- Manufactured from grade 1/2 hardwood from responsibly managed sources

C112	pk 12	£0.62
C1144	pk 144	£6.52
C1500	Box bx 500	£19.39

- Eraser tipped HB pencils for handy correction

C212	Eraser Tipped HB	pk 12	£0.79
------	------------------	-------	-------

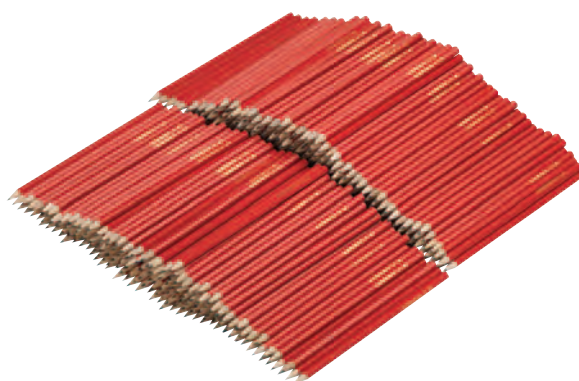

B

C Staedtler Noris Pencils

- The classic yellow and black pencil
- Available in 2B, H, 2H and HB
- Pack of 1500 HB supplied in a Gratnell's Tray
- Ideal for everyday classroom use and art & craft

1212B	2B	pk 12	£1.95
121H	H	pk 12	£1.95
1212H	2H	pk 12	£1.95
121HB	HB	pk 12	£2.17
121LST	HB	pk 150	£16.95
121HLS5	HB	pk 600	£58.94
12110G	HB	pk 1500	£139.62



C

D Half Pencils

- Pocket length hexagonal blacklead pencils
- Pre-sharpened for immediate use
- Unpainted wooden barrel
- Ideal for use with compasses

27026	pk 144	£5.13
-------	--------	-------



D



CALL US ON 01527 878348



VISIT WWW.FORWARDPRODUCTS.CO.UK

NEW!

A



A Colourworld Colouring Pencils

- The colourworld pencils are full size and contain an assortment of coloured leads

CWCOL12 pk 12 £0.95

B



B Lyra Ferby Triangular Barrel Colouring Pencils

- The famous 'Ferby' pencils
- A half length colouring pencil in a natural wood finish
- Triangular Grip for easy handling
- Vibrant, opaque colours

970H96 pk 96 £43.24

C



C Lyra Jockey Jumbo Pencils

- Lyra's Jockey Jumbos are exceptionally good value
- Chunky hexagonal pencils for younger children
- Available in packs of 12 or classpacks of 144 in a Gratnell's tray

LY813 pk 12 £3.87
LY820 tray 144 £27.59

D



D Helix Oxford Colouring Pencils

- Quality full and half length pencils at excellent prices!
- Handy pack sizes

HX5010 Half Length pk 12 £1.10
HX3010 Full Length pk 12 £1.34
HX4010 Full Length pk 24 £2.47

LOWEST PRICE

E



E Classmaster Colouring Pencils

- Standard full length colouring pencils
- Available in handy wallets, mega bulk boxes of 500 or class packs of 288 (12 colours)

ECP12 pk 12 £1.20
ECPCP Class Pack pk 288 £21.85
ECP500 Bulk Box pk 500 £35.95



A Stabilo Colouring Pencils

- Full length colouring pencils with hexagonal barrels
- Available in class packs of 288 (12 colours)
- Supplied in storage tray

STCP288H* pk 288 £33.13

*While stocks last



A

B Staedtler Essentials Colouring Pencils Classpack

- Supplied in a classpack of 288 these are high quality Staedtler colouring pencils
- In a classic hexagonal shape

STECP288 pk 288 £29.99



B

C Eziglide Premium Colouring Pencils

- Superb quality assorted colouring pencils
- A quality alternative to Staedtler
- Excellent for all types of colouring
- 12 assorted high pigment colours
- Break-resistant and super-bonded leads

FEGCP12 pk 12 £1.41
 FEGCP144 pk 144 £13.13
 FEGCP288 pk 288 £25.22



D Staedtler Noris Club Pencils

- Full length colouring pencils
- Available in wallets of 12, box of 185 or Grattnell's trays of 288 pencils
- Excellent quality for trouble free performance

NC12 pk 12 £2.14
 NC144 pk 185 £23.16
 NC288 pk 288 £42.17



D

EZIGLIDE features:

- High quality, strong hydrocarbon tips, ideal for classroom use

- Specially designed for drawing and art applications
- Excellent colour laydown which is bleed-resistant on most papers
- Non-toxic, washable, water based ink



A EziGlide ColourFun Broad or Fine Felt Tip Classpacks

Premium quality felt tips, which perform as well as the 'leading brand' at a very competitive price point!

- High quality, hardwearing round ended polyester fibre tip
- Ideal for detailed colouring and drawing
- Transparent ink allows additional colours to be created with overlays of brighter colours
- Large ink reservoir to increase life of pen
- Ventilated safety cap
- Fine tip line width is 0.6mm and broad tip line width is 1-2mm
- Available in Fine and Broad Tip in assorted packs of 288

CCFT12	Fine	pk 12	£2.10
CCFT36	Fine	pk 40	£7.54
CCFT288	Fine	pk 288	£44.98

CCBT12	Broad	pk 12	£2.10
CCBT36	Broad	pk 40	£7.54
CCBT288	Broad	pk 288	£44.98

B EziGlide ColourFun Jumbo Markers

- Transparent ink allows additional colours to be created with overlays of the brighter colours
- Large ink reservoir to increase life of pen
- Bullet Tip line width is 1-3mm and Chisel Tip line width is 5-7mm
- Choose from Bullet or Chisel Tip in an assorted classpack of 144

EGJMAC*	Chisel	pk 144	£19.54
---------	--------	--------	--------

* While stocks last

C EziGlide ColourFun Conical Felt Tip Markers

- Ideal for line drawing and brush strokes
- Ventilated safety cap
- Line width 1-2mm
- Available in an assorted classpack of 288

EGCC288	pk 288	£21.15
---------	--------	--------

* While stocks last



A Berol Felt Tips

Colourbroad

- 1.7mm fibre tip for colouring larger areas

CBW12	Wallet 12	£3.84
CBT42	Tub 42	£11.69
CBCP	Classpack 288	£61.53

Colourfine

- 0.6mm fibre tip for detailed work

CFW12	Wallet 12	£3.84
CFT42	Tub 42	£11.69
CFCP	Classpack 288	£61.53



A

B Berol Colourmarker Felt Tips

- Jumbo bullet tips for lettering, posters and flip charts
- Contains 12 assorted colours

CMB12	pk 12	£6.25
CMBP	pk 144	£68.17



B

C Edding Colour Markers Assorted

- Brilliantly soft fibre pens
- Soft nib can write on most textiles
- 3 day cap-off technology prevents nibs from drying out
- Colours are intermixable until ink dries

EDCB12	Bullet Tip	pk 12	£4.27
EDCB144	Bullet Tip	pk 144	£47.60
EDCC12	Chisel Tip	pk 12	£4.27
EDCC144	Chisel Tip	pk 144	£47.60



C

D Stabilo Power Broad Felt Tips

- Broad, 2mm tip for colouring larger areas
- Vibrant, washable colours
- Super resilient tips

STPW12	wallet 12	£2.50
SPB144	Classpack in Tray 144	£36.09



E

E Stabilo Power Max Broad Felt Tips

- Thick, durable, push resistant XL-tip (line width approx. 3mm)
Up to 8 weeks cap off time
- Grattnell's tray, with 96 pens in 12 colours

SPMBFT96	Classpack in Tray	pk 96	£38.09
----------	-------------------	-------	--------



F

F Stabilo Trio Fine Felt Tips

- Stabilo fine fibre tips with 0.7mm tips
- Vibrant, washable colours

STTR12	Fine	wallet 12	£2.50
--------	------	-----------	-------

G Felt Tip Pens

- Conforms to EN71
- Contains washable non-toxic inks

Fine Tip

FELT10	Fine	wallet 10	£0.57
FELT100T	Fine	tub 100	£5.88

- Jumbo felt tip pens for posters and larger areas of colour work

FELTJ10	Jumbo	wallet 10	£2.19
---------	-------	-----------	-------



G

A



B



C



D



E



F



G



A Crafty Foam Shapes

- Vibrant set of foam stamps with 24 assorted fun designs
- Made of durable EVA foam, easy and comfortable to grip and hold
- 18mm thick & approx. 85mm across
- Ideal with ink pads or children's paint

AFOAMS	set 24	£5.63
--------	--------	-------

B Giant & Rainbow Ink Pads

- Giant 15cm diameter ink pads, ideal for use with foam stamps, hands & feet
- Tested to EN71, safe to use with hands and feet
- Set of 6 pads containing red, yellow, blue, green, orange, purple colours
- Rainbow pad has: 1 segment each of red, yellow, blue, green, orange & purple

AGIPASS	Asst Colour Pads	set 6	£11.71
AGRAINP	Rainbow Pad	each	£2.85

C Matchsticks

AMATCHP	Plain	pk 1000	£0.59
WK8545	Coloured	pk 1000	£0.77

D Lollipop Sticks

- Ideal for all art, craft & modelling projects
- Available in natural or coloured
- Approximately 114 x 10mm

WL8740	Natural	pk 1000	£7.26
ALSASS	Coloured	pk 1000	£8.43

E Jumbo Lollipop Sticks

- They can be painted and glued and are ideal for many model making projects
- Approximately 150 x 18mm

ALSJUM	Large Plain	pk 100	£1.58
ALSJUC	Large Coloured	pk 100	£1.58

F Natural Dolly Pegs

- Great for making dolls and characters

WP8550	pk 24	£2.43
--------	-------	-------

G Wooden Numbers & Letters

- Wooden templates that develop children's hand eye co-ordination, dexterity and motor skills
- Lower case letters 3mm x 50mm
- Numbers 3mm x 70mm

FF8090	Letters	pk 26	£2.41
FF8091	Numbers	pk 20	£2.41



A Modelling Boards

- Pack of 10 boards
- Made of MDF with approximate dimensions 20cm x 30cm x 3mm
- Inexpensive, portable working surface which also protects the surface below from stains and scratches

AMODBS pk 10 £7.77



A

B Modelling Material

- Non-hardening
- Manufactured especially for school use
- Non-toxic, non-marking, long lasting material
- Available in 3kg assorted tub

MMA3K each £8.50



B

C Skin Tone Modelling Material

- Non-hardening
- Non-toxic modelling material
- 6 colours per pack
- 500g

CC50002 each £1.57



C

D Rainbow Colours Modelling Material

- Coloured, non-hardening modelling material
- Non-toxic
- Assorted pack of 6 rainbow colours
- 500g

RCMMAT each £1.46



D

E Air Hardening Clay

- Mineral and water based, non-fibrous material
- Stone colour with soft texture
- 2.5kg in handy pail with lid and handle

CLAY25	Stone	2.5kg	£4.93
CLAY25TC	Terracotta	2.5kg	£4.93
CLAY125ST	Stone	12.5kg	£9.58



E

F Super Soft Dough

- Top quality reusable modelling dough
- Very soft and easily moulded by the smallest hands
- 150g tubs
- Assortment of vivid colours

PLAYDOH pk 24 £18.93



F

A



A Papier Mache

- Art-Mache. Ready made papier mache - just add water and mix
- 1Kg

MACHE	each	£5.45
-------	------	-------

B



B Modelling Rock

- A fine gauze impregnated with a quick drying plaster that is ideal for creating casts or moulding shapes

LPMOD	6cm x 2m	each	£0.59
MR15080	150mm X 80m	each	£20.48

C

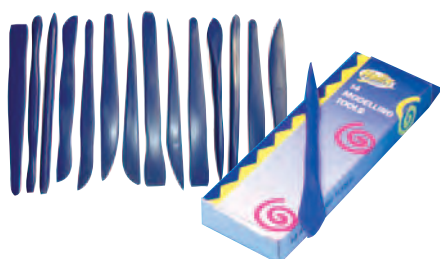

C Modelling Tools

- Set of 14 assorted plastic tools

MTOOLS	pk 14	£1.58
--------	-------	-------

D



D Assorted Neoprene Sheets

- A pack of 10 neoprene sheets in assorted colours
- A tactile material that is easy to cut with scissors or a knife
- Ideal for collage work, modelling and jewellery making
- Dimensions 25cm x 30cm, thickness approximately 2mm

ANCSASS	pk 10	£1.94
---------	-------	-------

E

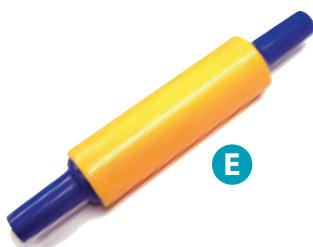

E Plastic Rolling Pin

- Approximate length 20cm, diameter 4cm. Ideal for use with the dough cutters to spread the dough evenly before shapes are cut.

ASPRPIN	each	£0.98
---------	------	-------

F



F Small Rolling Pins

- Pack of 4 assorted, patterned, wooden rolling pins
- Patterns : square contours, concave grooves, smooth, & diamond contours

ARPSAP	pk 4	£7.16
--------	------	-------

G

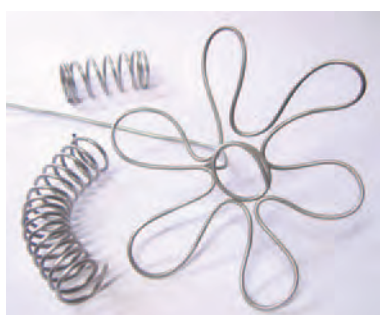

G Modelling Wire

- Mild steel wire ideal for modelling and construction work
- Galvanised to resist corrosion – suitable for modelling outdoors
- Supplied in a coil of 500g
- Wire diameter 1.0mm
- Total length approximately 80m

GWIRE1500	each	£5.08
-----------	------	-------



A Every Day Craft Box

- A super value assortment of the most popular craft items
- Quality products suitable from Foundation Stage upwards
- 1 x Tissue Tower: 4600 squares of assorted tissue paper
- Pom Poms 100 assorted sizes and colours
- Feathers: assorted colours - 50g
- Pipecleaners pack of 100 6mm x 300mm assorted
- Wiggle Eyes: 2 x 100 assorted size eyes
- Foil Shred: 3 x 50g assorted packs
- EVA Shapes: 1 pack each of peel and stick transport & flowers felt shapes
- Wooden letters & numbers: 1 pack of 26 letters and 1 pack of 20 numbers
- Pack of 200 assorted EVA foam shapes
- Tissue circles and squares: 480 15cm squares and 480 15cm circles, assorted
- Dazzle dots - 10 x 1m strips
- All contained in a deep Grattnell's tray



Contents may be substituted with suitable alternatives of equal or greater value in the event of stock shortages.

EDCCP each £62.84

B Assorted Pompoms

- Assorted chenille and glitter pompoms
- Suitable for all craft activities including collages



PP0100 pk 100 £2.80

C Assorted Ribbons

- Ribbons in assorted sizes, colours and materials
- 100g bag



RIBBAS each £4.24

D Dazzle Dots

- Assorted sparkling strips of self-adhesive 'dots'
- 10 x 1m strips



DDOTS pk 10 £3.20

E Poly-prop Curling Ribbon

- 6 x 20m ribbon eggs
- Colours include Gold, White, Red, Green, Blue and Cerise in clear poly-bag



PPCR205 pk 6 £1.87



CALL US ON 01527 878348



VISIT WWW.FORWARDPRODUCTS.CO.UK

A



A Pipecleaners

- Assorted colours
- Great for model making and collage work

PIPE154	150 x 4mm	pk 100	£1.20
PIPE306	300 x 6mm	pk 100	£2.05
PIPE3012	300 x 12mm	pk 50	£2.77

B



B Glitter Pipecleaners

- Ideal for festive decorations and 3D models
- 300 x 6mm
- Assorted colours

PIPEGS		pk 100	£4.49
--------	--	--------	-------

C



C Coloured Feathers

- Ideal for arts, crafts and costume making
- 50g bag

FT6100		each	£4.22
--------	--	------	-------

D



D Assorted Buttons

- Fantastic classpack of buttons
- Use for all art and craft, including sewing and card making
- Colours may vary

BU4510		500g bag	£7.23
--------	--	----------	-------



A Art Straws

- Cut, bend, colour & glue these paper straws
- Ideal for 3D model making and DT

ART6W	6mm White	pk 900	£15.21
ARTASS	Asst Cols & Sizes	pk 1350	£16.92



A

B A4 Felt Sheets

- Sheet sizes A4
- 4 Sheets each of 8 colours = total 32

FF0600		pk 32	£5.93
--------	--	-------	-------



B

C Multicultural Paper Faces

- 8 skintone shades
- For projects involving different people throughout the world
- Ideal for collage
- 150mm high and 130mm wide

MDC5697		pk 50	£4.18
---------	--	-------	-------



C

D Multicultural Paper Dolls

- 8 skintone shades
- Ideal for making puppets or portraits
- Dress with collage clothes
- Height approx 270mm

MDC4587		pk 50	£4.14
---------	--	-------	-------



D

A



A Assorted Foam Shapes

- Pack of 200 EVA shapes in various colours and sizes

FV0001	pk 200	£2.44
--------	--------	-------

B



B Wiggle Eyes

- Wiggle eyes in assorted sizes, and colours
- Packs of 560 come in handy plastic stacker tubs
- All packs contain assorted sizes

EY5330	Black & White Round	pk 100	£2.44
1842890	B&W Oval & Round	pk 560	£5.63

C



C Assorted Plastic Beads

- Assorted colours and shapes
- 450g bag

BEADSPL	each	£4.35
---------	------	-------

D



D Sequins Bulk Tub

- A terrific assortment of eyecatching shapes in various sizes
- 500g tub

SEQ	each	£15.35
-----	------	--------

E



E Shimmer Shower

- Perfect for mosaic collages, parties and general art and craft
- Assorted metallic mosaic foil pieces in a 100g bag

SHOWER	each	£2.39
--------	------	-------

F



F Giant Spangles Mix

- Extra large shapes which are easier for young children to handle
- 100g assorted bag

7050	each	£3.64
------	------	-------



A Assorted Glitter Shakers

- High quality glitter flakes
- 250g dispensers

GSK6A pk 6 £24.35



A

B Glitter Phials

- A pack of 6 popular colours in easy-to-use shaker-top phials
- Includes red, blue, green, silver, gold and multi coloured 7.2g phials
- A great value pack ideal for sharing between tables

28680 pk 6 £2.44



B

C Acrylic Jewels

- Assorted colours & shapes
- 500g bag

ACJEWS each £11.74



C

D Metallic Foil Shreds

- 5 bags of different coloured foil shreds
- 30g per bag

MFS pk 5 £4.35



D

E Calendar Tabs

- Great for end of year activities
- Ideal for making personalised calendars
- 74 x 47mm

CTAB Without Covers pk 50 £3.29



E

A



A Instant Snow

- 100g of an amazing non-toxic super absorbent powder
- Expands to 100 times its original volume when you add water
- Looks and feels like real snow
- Easy to clean
- Ideal for parties, Christmas decorations, science projects and photography

AISNOW	100g	£5.80
--------	------	-------

B



B Coloured Sand Shaker

- Brightly coloured sands in classroom sized shaker bottles containing 350g each
- Box 8 assorted bottles

CSS8	pk 8	£11.90
------	------	--------

NEW!

C



C Playpit Sand

- 25 Kg bag
- Accessories not included

SAND25	each	£10.99
--------	------	--------

D



D LED Flickering Tea Lights

- Set of 12 battery operated tea lights
- Light flickers to imitate a real candle
- CR2032 battery supplied lasts for 40-60 hours
- Diameter 38mm, overall height 38mm
- Will fit in a standard tea light holder

ALEDTEA	pk 12	£5.57
---------	-------	-------

E



E Quality Paper Masks

- These very strong paper masks are the best for decorating. Unlike the plastic masks which are flexible these are firm meaning paint and decorations do not flake off
- Ideal for use in roll play and art activities.

PM2130	pk 30	£19.95
--------	-------	--------

F



F White Play Masks

- Great for storytelling and drama, ideal for children to create their own interpretation of the mask.
- Play masks are specially coated to accept paint, crayon, pencil and adhesives
- Fitted with elastic
- Pre-moulded PVC
- Size 185mm x 150mm

LP001	pk 10	£7.66
-------	-------	-------



A Masking Tape

- Ideal for spray paint masking and general studio use
- 24mm x 50m

F01789 pk 12 £14.89



A

B Spray Adhesive

- Ideal for repeated mounting of light materials such as film and acetate
- CFC Free
- Choose from value or 3M branded 'Spraymount'
- 400ml

QMAD	Q Connect	400ml	£5.15
3MSPRAY	3M Spray Mount	each	£13.88



B

C Washable PVA Glue

- PVA adhesive recommended for children
- Formulated to wash out from clothes
- Available in 5 litre, 500ml or 180ml bottles

PVAW	5 Litre	each	£6.54
PVA500BL	500ml	each	£1.31
PVA180BL	180ml	each	£1.04



C

D Dispensing Pump for 5Lt Glue/Paint

- Strong plastic dispensing pump
- Less mess than pouring straight from the bottle

DP5LT each £2.99



D

E Glue Spreaders

- Versatile product, ideal for applying glue to photo's, card and paper
- Keeps fingers and hands clean

GSP12 pk 10 £0.63



E



CALL US ON 01527 878348



VISIT WWW.FORWARDPRODUCTS.CO.UK

A



A Wizard Glue Sticks

- Economical but reliable, solvent free gluesticks

GS10Q	10g Small	pk 12	£3.11
GS20Q	20g Medium	pk 9	£2.84
GS40Q	40g Large	pk 8	£3.50
GS4040	40g Large	pk 40	£13.86
GS40200	40g Large	pk 200	£66.68

B



B Pritt Sticks

- Brand leading gluesticks
- CPPSL100 is supplied in a Gratnell's tray with a clear lid

PSM12	Medium 20g	pk 24	£25.50
PSL10	Large 43g	pk 10	£13.11
PSL50	Large 43g	bx 50	£64.03
PSL100	Large 43g	bx 100	
	Includes 4 FREE		£103.84
CPPSL100	Tray 43g	pk 100	£130.22
PSJ90	Jumbo 90g	each	£4.74

C



C Sticky Fixers

- Ideal for fixing, mounting and display work
- Each pad can hold up to 90g in weight
- Permanent adhesive

37984	12 x 25mm	pk 56	£1.45
-------	-----------	-------	-------

D



D Sticky Fixer Strip

- Foam strip coated both sides with permanent adhesive
- Ideal for fixing, mounting and display work
- 1 metre of foam can hold up to 9kg in weight
- Each roll is 25mm x 3m

F03796		each	£3.09
--------	--	------	-------

E



E Hook & Loop S/A Pads

- Self adhesive hook and loop pads
- Great for hooks, signs, pictures and displays

4542		pk 24	£2.17
------	--	-------	-------



The Undisputed King of the Glue Sticks

"An Excellent alternative to the leading brand. We find them better quality than economy glue sticks, and certainly a lot less money than Pritt Sticks"
Sefton Park School



Economy Stick
Slightly cheaper
Inferior performance



Pritt Stick
Equivalent Quality
£41.85 more per 100

Order Details

QSTICK	Single 40g Quickstick	Each	£0.72
QST35	Class Pack 40g	Pk 35	£23.99
QST100	Bulk Box 40g Quickstick	Pk 100	£61.99
CPQST100	Gratnell's Tray 40g Quickstick	Pk 100	£69.60

Call for your free sample today!



CALL US ON 01527 878348



VISIT WWW.FORWARDPRODUCTS.CO.UK

A



A Quicktac Adhesive Putty

- Economical reusable adhesive will hold papers or light objects to most surfaces without marking

QTA140	140g	each	£1.44
--------	------	------	-------



B



B Wizard White Tack Adhesive Putty

- Reusable adhesive Wizard White Tack
- Clean, safe and easy to use
- For best results, use on non-porous surfaces

801072		pk 140g	£0.89
--------	--	---------	-------

C



C Blu-tack Adhesive Putty

- The original reusable adhesive putty

BLU120	Economy Pack 120g	each	£1.04
80108	Economy Pack 120g	pk 12	£12.46
BLU60	Handy Size 60g	each	£0.90
F00181	Handy Size 60g	pk 12	£8.57

D



D White Tack Adhesive Putty

- Sticks paper or small objects to a multitude of surfaces
- Fixes pictures, notes, memos, cards and decorations
- 60g handy sized packs

WHI60	White Tack	pk 12	£8.64
-------	------------	-------	-------

E



E Spray Mount Adhesive

- Ideal for repeated mounting of light materials such as film, acetate and layout paper
- Transparent and will not soak through or wrinkle paper
- CFC Free
- 400ml cans

QMAD	Economy	each	£5.15
3MSPRAY	3M Spray Mount	each	£13.88



07

DISPLAY

FLIPCHART EASELS & PADS	231-233
WALL PLANNERS	234
WHITEBOARDS	235-238
DRYWIPE EASELS	239-242
DRYWIPE BOARD MARKERS & ACCESSORIES	243-244
NOTICEBOARDS	245-252
DISPLAY STANDS	253



Non-returnable items, please report damages or discrepancies within 72 hours



A



3 YEAR WARRANTY

FOR FLIPCHART PADS
SEE PAGE 233

A Heavy Duty Flipchart Easel

- Large (100 x 70cm) magnetic dry wipe board with durable plastic coating
- Dual thumb levers raise and lower the board height between 192cm and 125cm
- At its lowest position the board is ideal for children, sitting position or wheelchair friendly
- Foot bar aids writing position and board positioning
- Interlocking legs that snap together for easy portability
- Back feet have integral wheels to help moving over larger distances
- Integrated rear carry handle aids lifting and carrying
- Full width large capacity (67cmx18cm) pen tray is housed inside the A frame
- Integrated side arm, which can be mounted left or right handed
- Manufactured to highest TÜV Standard for Design & Safety
- 3 Year Warranty
- Total weight 11kg
- Minimal assembly required

CPR1070 each £294.30

B



B Heavy Duty Mobile Flipchart Easel

- Heavy duty mobile easel in a range of 6 colours
- Large magnetic whiteboard mounted on a height adjustable column
- Tubular steel base
- Locking castors
- Integrated pen tray
- Simple height adjustment
- Board size: H1000 x W680mm
- Max height 1900mm

HDFBK	Black	each	£137.17
HDFBL	Blue	each	£137.17
HDFRD	Red	each	£137.17
HDFWH	White	each	£137.17
HDFGY	Grey	each	£137.17
HDFGR	Green	each	£137.17

Please Specify:
Easel colour



A Economic Frameless Flipchart Easel

- Aluminium frame with steel drywipe surface to accept magnets
- Adjustable flip pad holders
- Rear leg has a brace for increased stability
- Supplied with clip-on pen tray
- Board size: H1000 x W680mm
- Max height: 1850mm

FEA1 each £50.56

Non-returnable items, please report damages or discrepancies within 72 hours

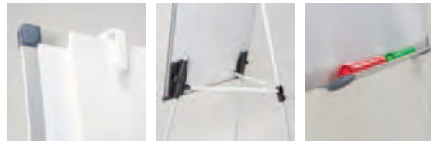

Clip on Pad Clamp Leg Brace for Stability Pen Tray



LOWEST PRICE

B Magnetic Drywipe Flipchart Easel with Footbar

- Best seller - very popular in classrooms
- Loop style leg provides extra stability
- High quality magnetic drywipe surface with attractive black aluminium frame
- Twin magnetic display side arms
- Easel is height adjustable and has a quick release pad changers as standard
- Takes any size flipchart pad

FCEWF each £110.84



B

FOR FLIPCHART PADS
SEE PAGE 233

C Deluxe Loop Leg Flipchart Easel

- Loop leg design creates very steady base and foot bar aids stability when writing
- Double sided magnetic whiteboard can be angled flat and is fully height adjustable
- Suitable for A1 standard 2 hole drilled pads
- Optional carry bag
- Board Size: H860 x W650mm
- Max height: 1720mm

DFCEBK	Black	each	£84.60
DFCERD	Red	each	£84.60
DFCEBL	Blue	each	£84.60
DFCEGN	Green	each	£84.60
DFCEWH	White	each	£84.60
DFCEGY	Grey	each	£84.60



C

D Mobile Flipchart Easel

- Metal pad clamp with hangers to take all standard A1 flipchart pads
- Magnetic whiteboard is height adjustable with spring loaded assist
- Two side arms are supplied as standard for hanging completed sheets
- Full width pen tray
- Board Size: H1000 x W680mm
- Max height: 1900mm

MFEA1 each £126.47



D



CALL US ON 01527 878348



VISIT WWW.FORWARDPRODUCTS.CO.UK

A



A Standard A1 Flipchart Pads

- Bleed resistant white paper for use with flipchart markers
- Perforated at head for easy removal of unused sheets
- Fit all standard flipchart easels
- 40 sheets per pad
- Punched 2 holes at top

DFPSTD	Plain	pk 5	£15.40
DFPGRD	Feint Gridlines	pk 5	£29.08

B



B Specialist A1 Flipchart Pads

- High quality 80gsm paper
- Perforated at head for easy removal of sheets
- 30 leaves per pad
- Literacy pads ruled with 4 sets of learn to write guides
- Numeracy pads ruled with 50mm feint squares
- Lines pads are 50mm ruled
- Punched with 2 holes at the top

DFPLTW	Literacy	pk 5	£27.67
DFPNUM	Numeracy	pk 5	£27.67
DFP50S	Lined 50mm	pk 5	£27.67

C



C Selfstick Fold Out Flipchart Pads

- Self stick repositionable adhesive flipchart pads
- Just peel off each sheet and stick to the wall or door
- No need for pins or tape
- Lightweight, complete with a sturdy back card and table pad
- Pad comes flat and instantly converts for table top presentation
- High quality paper prevents pen bleeding through
- Perforated for easy tear off
- 20 sheets of plain paper per pad

DFPSFO	each	£12.60
--------	------	--------

D



FOR FLIPCHART MARKERS

SEE PAGE 88

D A1 Self Adhesive Flipchart Pads

- Use like sticky notes
- No need for adhesive tape, the self-adhesive strip across the back of each sheet allows them to be stuck on walls and windows around the room
- 30 sheets of 75gsm bleedproof paper

DFPSA	pk 2	£36.05
-------	------	--------



A Drywipe Annual Year Planners

- Comprehensive range of perpetual year planners to suit any office
- Available in three styles to suit your needs; a versatile annual planner, a monthly planner and day planner
- Perfect for an overview of your medium and long term projects and activities
- All planners are magnetic and come with an easy clean drywipe surface
- Free pen tray, drywipe marker and magnets included
- Comes with all the fittings for ease of hanging
- Size: W900 x H600mm

F07740	Annual Planner	each	£45.12
F07361	Annual Month Planner	each	£45.12
F07360	Annual Day Planner	each	£45.12



B Drywipe Month Planner

- Plan your month ahead with this easy to use perpetual planner
- All planners are magnetic and come with an easy clean drywipe surface
- Free pen tray, drywipe marker and magnets included
- Comes with all the fittings for ease of hanging
- Size: W900 x H600mm

F07640	each	£45.12
--------	------	--------

C Drywipe Week Planner

- Perfect for planning on a week to week basis
- Days of the week are displayed along the top of the planner with ample space to plan your activities
- Magnetic surface with easy to clean drywipe surface
- Aluminium frame
- Free pen tray, drywipe marker and magnets included
- Comes with all the fittings for ease of hanging
- Size W600 x H400mm

F07340	each	£32.30
--------	------	--------

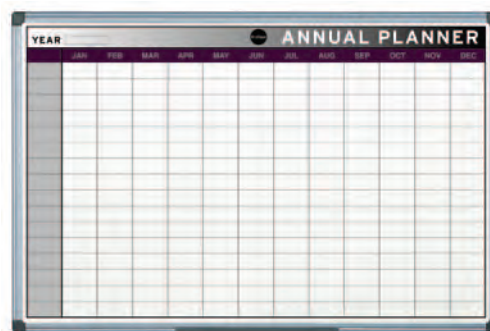

Annual Planner

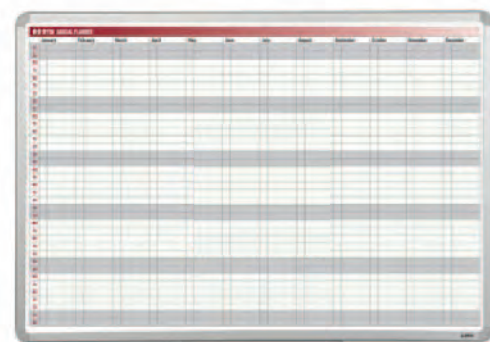

Annual Month Planner

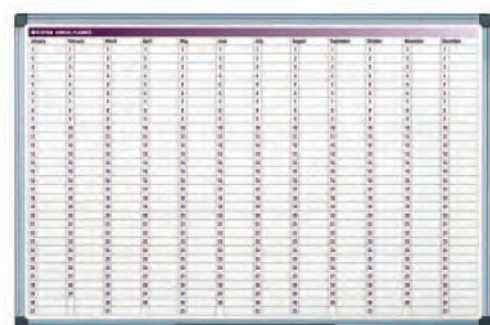

Annual Day Planner

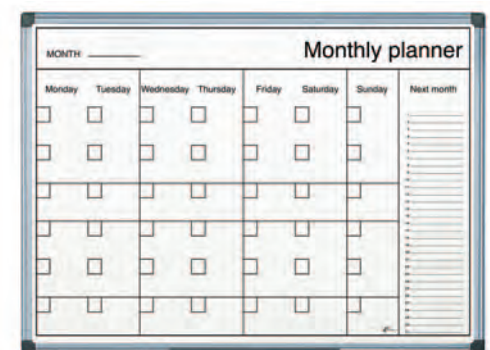

Drywipe Month Planner

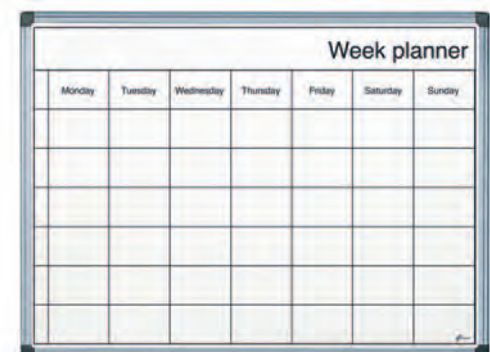

Drywipe Week Planner



CALL US ON 01527 878348



VISIT WWW.FORWARDPRODUCTS.CO.UK

A



Non-returnable items, please report damages or discrepancies within 72 hours

B



C

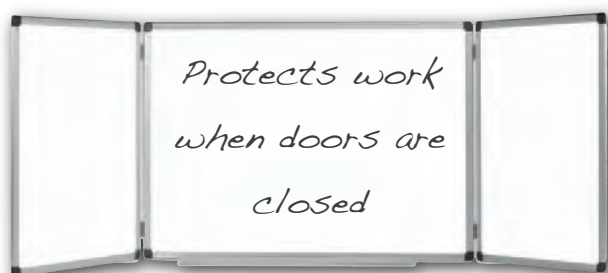

A Non-Magnetic Whiteboards

- This plain double sided whiteboard has a revolutionary new surface which is ultra smooth on both sides improving erasability and reducing ghosting
- Aluminium framed plain white surface, supplied with concealed wall fixings and pen tray
- All boards 1800mm wide and larger have extra central fixings at top and bottom for additional safety and stability

SMDW32	600 x 900mm	each	£22.14
SMDW43	900 x 1200mm	each	£32.09
SMDW44	1200 x 1200mm	each	£42.79
SMDW54	1500 x 1200mm	each	£54.56
SMDW64	1800 x 1200mm	each	£59.72
SMDW84	2400 x 1200mm	each	£74.87
SMDW88	2700 x 1200mm	each	£138.83

B Magnetic Whiteboards

- This economically priced whiteboard has a revolutionary new surface which is ultra smooth to improve erasability, with the added advantage of accepting magnets
- Aluminium framed plain white drywipe surface
- Supplied with concealed wall fixings and pen tray
- All boards 1800mm wide and larger have extra central fixings at top and bottom for additional safety and stability

SMDWM32	600 x 900mm	each	£33.77
SMDWM43	900 x 1200mm	each	£50.30
SMDWM44	1200 x 1200mm	each	£61.58
SMDWM54	1500 x 1200mm	each	£71.50
SMDWM64	1800 x 1200mm	each	£83.76
SMDWM84	2400 x 1200mm	each	£104.97
SMDWM88	2700 x 1200mm	each	£139.61

C Trio Whiteboards

- Unique design creates multifunctional ability
- Three separate magnetic whiteboard surfaces when open
- Aluminium framed with fixings and pen tray
- Sizes refer to central board

TR1010	900 x 600mm	each	£96.04
TR2020	1200 x 900mm	each	£154.84



A Vitreous Enamel Steel Magnetic Whiteboard

- Vitreous Enamel Steel - the ultimate in dry-wipe surfaces is guaranteed for 25 years - invest in the best
- Aluminium framed whiteboards with concealed corner fixings and pen tray
- Surface can be used with all brands of drywipe markers and also accept magnets
- All boards 1800mm wide and larger have extra central fixings at top and bottom for additional safety and stability

25 YEAR WARRANTY

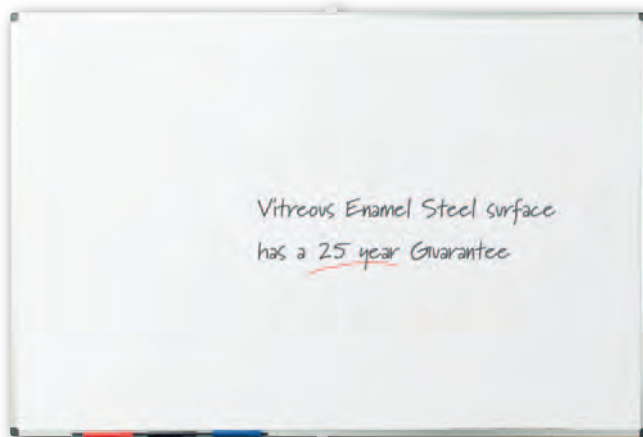

VDW32	900 x 600mm	each	£48.52
VDW43	1200 x 900mm	each	£69.97
VDW44	1200 x 1200mm	each	£95.74
VDW54	1500 x 1200mm	each	£120.17
VDW64	1800 x 1200mm	each	£140.64
VDW84	2400 x 1200mm	each	£179.39
VDW88	2700 x 1200mm	each	£229.55



B Glass Magnetic Whiteboard

- Incredibly stylish whiteboards, to give your rooms the finishing touch
- Works like a standard drywipe board, with standard drywipe markers and erasers
- Available in 8 sizes, right up to 2400 x 1200mm



GMW960	900 x 600mm	each	£97.16
GMW1065	1000 x 650mm	each	£116.91
GMW1290	1200 x 900mm	each	£168.06
GMW1212	1200 x 1200mm	each	£213.77
GMW1510	1500 x 1000mm	each	£221.85
GMW1812	1800 x 1200mm	each	£280.03
GMW2010	2000 x 1000mm	each	£300.46
GMW2412	2400 x 1200mm	each	£390.19



CALL US ON 01527 878348



VISIT WWW.FORWARDPRODUCTS.CO.UK

Non-returnable items, please report damages or discrepancies within 72 hours

A

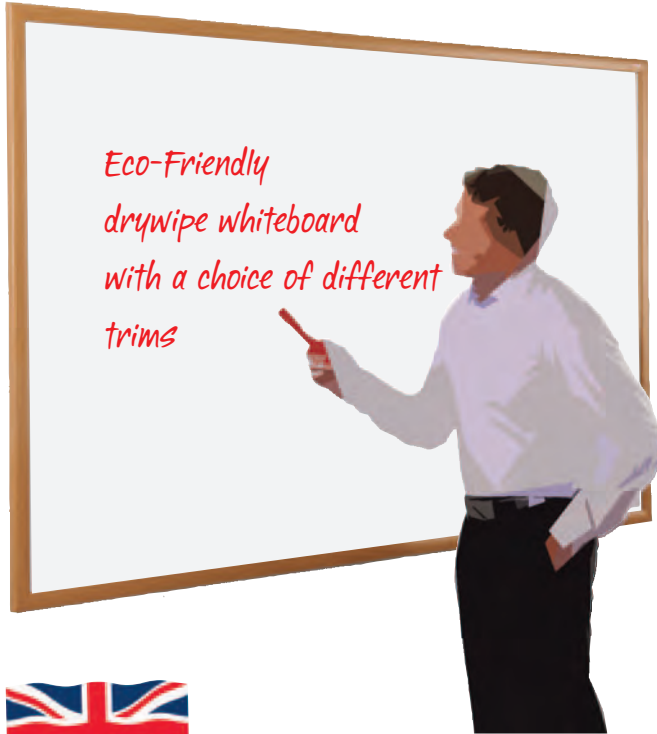

A Eco-Friendly Whiteboards

- The attractive contoured 35mm wide frame is available in a choice of Aluminium (AL), Blue (BL) or Light Oak (LO) effect finishes
- Almost entirely constructed from timber industry bi-products, and recycled materials
- Quality laminate drywipe surface
- Boards can be mounted portrait or landscape with fixings provided
- Made in the UK

EFW96**	900 x 600mm	each	£31.44
EFW129**	1200 x 900mm	each	£45.41
EFW1212**	1200 x 1200mm	each	£55.06
EFW1512**	1500 x 1200mm	each	£71.04
EFW1812**	1800 x 1200mm	each	£80.55
EFW2412**	2400 x 1200mm	each	£110.50

**Please specify frame colour when ordering

Frame Options



Aluminium Blue Light Oak



90% RECYCLED MATERIAL

ECO FRIENDLY PRODUCTS

These Eco-Friendly products are manufactured from sustainable and recycled raw materials and environmentally friendly manufacturing processes.

By weight these finished products use up to 90% recycled material, are assembled using solvent & VOC free adhesives, and all packaging uses recycled card.

We have also eliminated unnecessary plastic packaging and the product has the potential of 60% recyclability.



A Colour Edged Whiteboards

- Quality laminate drywipe surface
- Mounts flush to the wall due to its frameless design and simple 'through the board' fixings
- Choose from five bright colours with matching screw caps
- Low profile 2mm edge means boards can be mounted side by side virtually seamless
- Made in the UK

Non-returnable items, please report damages or discrepancies within 72 hours

CEW96**	900 x 600mm	each	£26.72
CEW129**	1200 x 900mm	each	£37.27
CEW1212**	1200 x 1200mm	each	£44.38
CEW1512**	1500 x 1200mm	each	£59.32
CEW1812**	1800 x 1200mm	each	£71.50
CEW2412**	2400 x 1200mm	each	£84.88

**Please specify frame colour when ordering

Frame Colour Options

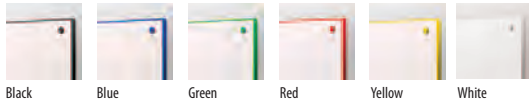

Black Blue Green Red Yellow White



A

The tough ABS colour edging adds a modern accent to an everyday product

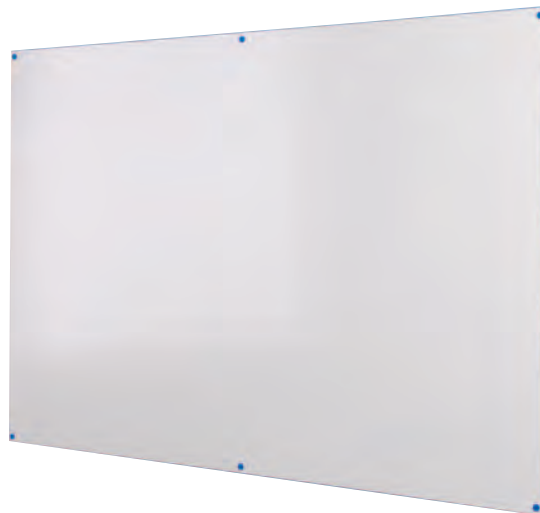

Have you seen our new range of Sienna furniture?



See pages 471-489 for details



CALL US ON 01527 878348



VISIT WWW.FORWARDPRODUCTS.CO.UK

A



10 YEAR WARRANTY

- Magnetic drywipe surfaces
- Extremely durable, stable and safe
- Quick and easy height adjustments achievable within seconds
- Four locking castors (where illustrated)
- Available with red or blue, high gloss, powder coated frames
- Flip chart fittings (where illustrated)
- Comes complete with a manufacturer's 10 year warranty
- Full length pen ledge
- A full range of spares are available
- Where illustrated, Gratnells school storage trays are included

Non-returnable items, please report damages or discrepancies within 72 hours

B



A Big A Frame Easel

- Includes two Gratnells storage trays
- White Board size: W900 x H900mm
- Height adjustable 1120, 1350, 1590 or 1800mm

BAFMEBL	Blue	each	£244.21
BAFMERD	Red	each	£244.21

B Single Sided Mobile Easel

- Includes one Gratnells storage tray
- White Board size: W600 x H900mm
- Height adjustable 1210, 1140, 1670 or 1880mm

SBMEPBL	Blue	each	£214.44
SBMEPRD	Red	each	£214.44

C



C Double Sided Mobile Easel

- Includes one Gratnells storage tray
- Front board adjustable only
- White Board size: W600 x H900mm
- Height adjustable 1220, 1440, 1680 or 1900mm

DBMEPBL	Blue	each	£260.37
DBMEPRD	Red	each	£260.37



A Double Sided Mobile Easel Landscape Style

- Includes three Gratnells storage trays
- Boards can be stepped independently, (see illustration)
- Specifically designed for 4 – 11 year old children
- White Board size: W900 x H600mm
- Height adjustable 810, 1030 or 1350mm

DBMELBL	Blue	each	£275.69
DBMELRD	Red	each	£275.69



B Large Desktop Easel

- Designed for easy transport between classrooms
- White Board size: W600 x H600mm

LMDTEBL	Blue	each	£117.20
LMDTERD	Red	each	£117.20



C Small Individual Desktop Easel

- Specifically designed for individual pupils
- White Board size: W600 x H300mm

SIDTEBL	Blue	each	£87.84
SIDTERD	Red	each	£87.84



A



Non-returnable items, please report damages or discrepancies within 72 hours

A Magnetic Revolving Whiteboards

- Mobile revolving white board with pen tray and locking castors
- Board rotates 360° and will lock at any angle
- Anodised aluminium frame board
- Gridded one side and plain on the other
- 4 year warranty on board surface

EREV129	1200 x 900mm	each	£107.13
EREV1212	1200 x 1200mm	each	£127.73
EREV1215	1200 x 1500mm	each	£139.36
EREV1218	1200 x 1800mm	each	£157.27

FOR BOARD MARKERS
SEE PAGES 93-96

FOR BOARD ERASERS
SEE PAGES 97-98

B



B Tilting Portable Duo Boards

- Flipchart easel and magnetic dry wipe board on one side, notice board on the other
- Ideal where space is limited
- Height adjustable
- Portable and easy to use
- Castors lock down when in use
- Includes a bracket for holding flipchart pad

DUONB127	1200 x 700mm	each	£114.01
----------	--------------	------	---------



A Royal Reading & Writing Centre

- A magnetic dry erase metal surface which also supports long chart paper, pocket charts and magnetic letters
- 24" x 34" removable and adjustable double-sided magnetic dry erase board with lines spaces 1" apart on one side – hangs long or wide
- Built-in big book storage rack
- Shelf with two built-in small tubs for marker storage
- Two magnetic bulldog clips
- Removable and width adjustable snap on hooks for chart paper, pocket charts etc
- Removable and adjustable spring loaded book/marker ledge fastens securely to front and back at nine different levels
- Four clear sliding tubs for ease of access
- Four locking castors
- Foot activated brake system
- Ten year frame warranty
- Size 76cm x 78.75cm x 145cms



A

LC500 each £315.56



Non-returnable items, please report damages or discrepancies within 72 hours

B Junior Mobile Tilting Magnetic Whiteboard

- Practical floor standing whiteboard with plain, gridded or lined magnetic surfaces
- Double sided whiteboard mounted in a mobile frame
- Board can pivot and lock at a 40deg angle, therefore ideal for resting books or artwork on the full width ledge
- 4 castors 2 of which are braked
- Overall height 1300mm
- Choose from white frame with anodised aluminium board trim or red frame with multi-coloured board trim and a choice of grid or lines

DJMWWH	White Frame	each	£116.95
DJMWRE	Red Frame	each	£142.26



B



CALL US ON 01527 878348



VISIT WWW.FORWARDPRODUCTS.CO.UK

A



A Self-Adhesive Magnetic Tape

- Magnetised rubber material with adhesive surface which can be stuck to the back of paper or card
- 10mm x 10m roll

11898 each £13.87

B



B Coloured Whiteboard Magnets

- Ideal for holding notes or notices to magnetic boards
- 18mm magnets set in plastic head with domed top
- Assorted colour pack includes 2 each of green, blue, yellow, black, red and white

12053 pk 12 £26.68

C



C Economy Drywipe Markers

- Low odour ink dries instantly
- Assorted 4:- 1 each black, blue, red & green
- Brand may vary

Chisel Tip

26035WX	Black	pk 10	£2.17
26036WX	Blue	pk 10	£2.17
26037WX	Red	pk 10	£2.17
26009WX	Green	pk 10	£2.17
26038WX	Assorted	pk 4	£1.13

Bullet Tip

98001WX	Black	pk 10	£2.19
98002WX	Blue	pk 10	£2.19
98003WX	Red	pk 10	£2.19
98004WX	Green	pk 10	£2.19
98005WX	Assorted	pk 4	£1.12
98001BP	Black	pk 100	£17.95

D



D Penflex Drywipe Markers

- Bullet tips
- Xylene free drywipe markers for all whiteboards
- Low odour ink dries instantly

Assorted Colours

DWTA4	pk 4	£2.14
DWTA6	pk 6	£2.65
DWTA10	pk 10	£4.18

Single Colours

DWTBK	Black	pk 10	£4.18
DWTBL	Blue	pk 10	£4.18
DWTRD	Red	pk 10	£4.18
DWTGR	Green	pk 10	£4.18

E



E Penflex Drywipe Marker Classpacks

- Xylene free markers for all whiteboards
- Low odour ink dries instantly
- Bullet tips

Standard Barrels

P50BB	Black	pk 50	£17.44
P50AB	Asst	pk 50	£17.44



A EziGlide Drywipe Markers

A revolutionary new drywipe marker that writes effortlessly and is easily erasable due to its high quality ink formula and fibre tip.

- EziGlide have been designed to last longer and provide a consistent flow of ink
- Available in classpacks of 48 in Bullet or Chisel Tip and Black or Assorted Colours

EG48BG	Green Bullet Tip	pk 48	£15.79
EG48BL	Blue Bullet Tip	pk 48	£15.79
EG48BR	Red Bullet Tip	pk 48	£15.79
EG48BB	Black Bullet Tip	pk 48	£15.79
EG48CL	Blue Chisel Tip	pk 48	£15.79
EG48BC	Black Chisel Tip	pk 48	£15.79
EG48AB	Asst Bullet Tip	pk 48	£15.79
EG48AC	Asst Chisel Tip	pk 48	£15.79

Premium performance without the price tag!



B Berol Drywipe Markers

- Reliable drywipe markers, now at excellent prices!

Round Tip

DWMR8A	Assorted	pk 8	£6.16
DWMR12BK*	Black	pk 12	£7.64
DWMR48	Classpack Asst	pk 48	£23.09
DWMR48BK	Classpack Black	pk 48	£23.09

Chisel Tip

DWMW8A	Assorted	pk 8	£6.16
DWMW48	Classpack Asst	pk 48	£23.09
DWMW48BK	Classpack Black	pk 48	£23.09

* While stocks last



B

C Show-me Teacher Whiteboard Markers

- Full size premium drywipe markers
- Bullet tip with xylene-free, low odour ink
- Ventilated caps for safety
- 24 hour cap off time to prevent drying out

TWM10	Black	pk 10	£5.17
STM50	Black	pk 50	£23.47
STM4	Assorted	pk 4	£3.28



C

D Bic Drywipe Markers

- Bullet and chisel tip
- Tough and long lasting

Bullet

F04692	Black	pk 12	£10.95
F03784	Blue	pk 12	£10.95
F06222	Red	pk 12	£10.95
F06218	Green	pk 12	£10.95
F03504	Assorted	pk 4	£4.57

Chisel

75109	Black	pk 12	£10.75
F01754	Assorted	pk 4	£4.29



D

Non-returnable items, please report damages or discrepancies within 72 hours

A

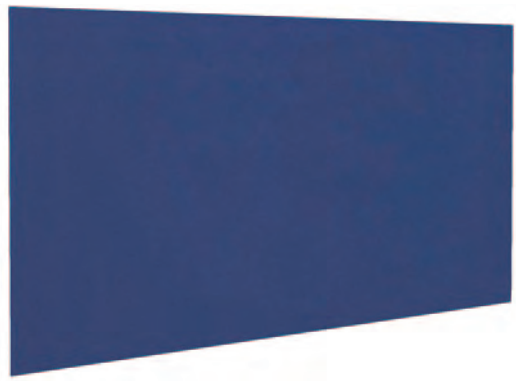

A Unframed Noticeboards

- These frameless pinboards are made from high quality board and felt
- Fire resistant and colour fast
- Available in Blue (BL), Green (GR), Red (RD), Silver (SV) & Wine (WN)
- Can be made to a custom size - POA
- 3 largest sizes are supplied in 2 parts

UNB9060**	900 x 600mm	each	£19.27
UNB129**	1200 x 900mm	each	£26.93
UNB1212**	1200 x 1200mm	each	£32.30
UNB1512**	1500 x 1200mm	each	£43.95
UNB1812**	1800 x 1200mm	each	£47.77
UNB2412**	2400 x 1200mm	each	£57.99

**Please specify colour when ordering

B



B Standard Noticeboards

- Made in the UK to the highest standards
- Felt surface accepts Velcro® as well as pins - colour fast to BS1006
- Available in 5 standard felt colours - Blue (BL), Burgundy (BG), Red (RD), Green (GR) or Grey (GY) & special fabrics for an extra charge. Please call for more information
- Other sizes/colours are available – please enquire (P.O.A.)
- Flush fix corners conceal wall fixings (supplied)
- Fire retardant fabric

NBS96**	600 x 900mm	each	£23.64
NBS129**	900 x 1200mm	each	£30.44
NBS1212**	1200 x 1200mm	each	£37.63
NBS1512**	1500 x 1200mm	each	£51.26
NBS1812**	1800 x 1200mm	each	£53.40
NBS2412**	2400 x 1200mm	each	£63.44

** Please specify colour when ordering, see swatch at bottom of page

C



C Standard Tamperproof Noticeboards

- Inexpensive solution to protect displays from casual interference
- Each door secures with 2 matching lock for convenience
- Felt surface accepts Velcro® as well as pins - colour fast to BS1006
- Available in 5 standard felt colours - Blue (BL), Burgundy (BG), Green (GR), Grey (GY) or Red (RD) and special fabrics for an additional charge. Please call for more information
- Other sizes/colours are available – please enquire (P.O.A.)
- Fire Retardant Fabric

Single Door

LNB21**	600 x 450mm	each	£48.57
LNB32**	600 x 900mm	each	£56.91
LNB33**	900 x 900mm	each	£72.89
LNB43**	1200 x 900mm	each	£86.70
LNB44**	1200 x 1200mm	each	£116.56

Double Doors

LNB64**	1200 x 1800mm	each	£172.84
LNB84**	1200 x 2400mm	each	£207.95

** Please specify colour when ordering, see swatch below

Please Specify:
Felt/fabric colour

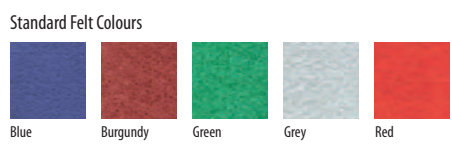

Non-returnable items, please report damages or discrepancies within 72 hours

A Contemporary Unframed Noticeboard

- Eye catching range of noticeboards in bright contemporary felt colour finishes
- A selection of 6 fabric colours: Cyan (CY), Lilac (LC), Magenta (MG), Orange (OR) Bright Green (BG) & Purple (PU)
- Designed for use with both pins and Velcro
- 3 largest sizes are supplied in 2 parts

UNC960**	900 x 600mm	each	£25.78
UNC1290**	1200 x 1200mm	each	£34.07
UNC1512**	1500 x 1200mm	each	£53.22
UNC1812**	1800 x 1200mm	each	£67.15
UNC2412**	2400 x 1200mm	each	£67.53

** Please specify colour when ordering, see swatch at bottom of page



A

B Contemporary Framed Noticeboards

- Brighten up your school with these extra stylish noticeboards
- Available in 6 stylish felt options
- Made in the UK to the highest specification
- Accepts Velcro fasteners and pins
- 5 sizes available
- 2 largest sizes are supplied in 2 parts

CNB960**	900 x 600mm	each	£31.38
CNB1290**	1200 x 900mm	each	£43.62
CNB1512**	1500 x 1200mm	each	£63.41
CNB1812**	1800 x 1200mm	each	£68.81
CNB2412**	2400 x 1200mm	each	£85.76

** Please specify colour when ordering, see swatch at bottom of page



B

C Contemporary Tamperproof Noticeboards

- Brighten up your school with these extra stylish noticeboards
- Available in 6 stylish felt options
- Made in the UK to the highest specification
- Accepts Velcro fasteners and pins
- 4 sizes available

1 Door

CTPNB960**	900 x 600mm	each	£77.57
CTPNB990**	900 x 900mm	each	£103.87
CTPNB1290**	1200 x 900mm	each	£111.35
CTPNB1812**	1800 x 1200mm	each	£204.60

** Please specify colour when ordering, see swatch at bottom of page



C

Contemporary Felt Colours

Please Specify:
Felt/fabric colour

Purple	Magenta	Lilac	Orange	Cyan	Bright Green

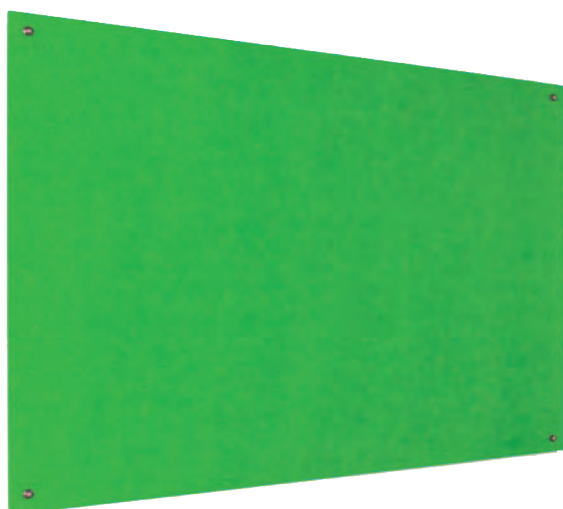

Fire Resistant

Please Specify:

Fabric colour

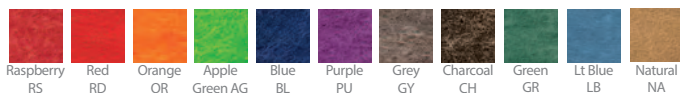

Non-returnable items, please report damages or discrepancies within 72 hours

Frameless EcoColour® Noticeboards

A fantastic range of recycled noticeboards that are not only fire resistant but also have acoustic properties

- Fire Resistant to Class 0
- Made from recycled materials
- Acoustic properties up to NRC 0.8
- Self- coloured pinnable core
- Available in 11 different colours
- 3 largest sizes are supplied in 2 parts

DEUFB32*	W900 x H600mm	£28.23
DEUFB43 *	W1200 x H900mm	£47.90
DEUFB44 *	W1200 x H1200mm	£61.43
DEUFB54 *	W1500 x H1200mm	£74.70
DEUFB64 *	W1800 x H1200mm	£91.86
DEUFB84 *	W2400 x H1200mm	£123.24

*Please specify colour when ordering



Fire Resistant

Please Specify:

Fabric colour

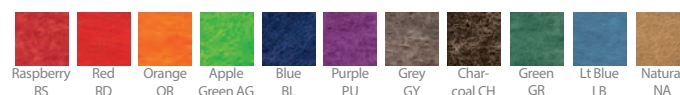

Aluminium Frame EcoColour® Noticeboards

A fantastic range of recycled noticeboards with aluminium frame that are not only fire resistant but also have acoustic properties

- Fire Resistant to Class 0
- Made from recycled materials
- Acoustic properties up to NRC 0.8
- Self- coloured pinnable core
- Available in 11 different colours

DE22632*	W900 x H600mm	£38.37
DE22643*	W1200 x H900mm	£68.54
DE22644*	W1200 x H1200mm	£84.61
DE22654*	W1500 x H1200mm	£100.97
DE22664*	W1800 x H1200mm	£122.02
DE22684*	W2400 x H1200mm	£151.38

* Please specify colour when ordering



Light Oak Effect Premium Aluminium Frame EcoColour® Tamperproof Noticeboard

Stunning light oak effect aluminium frame with EcoColour® recycled material which is not only fire resistant but also has acoustics properties.

- Fire resistant to Class 0
- Made from recycled material
- Acoustic properties up to NRC 0.8
- Attractive contour frame design
- Available in 11 different colours

Single Door

DECBT32*	W600 x H900mm	£102.40
DECBT43*	W900 x H1200mm	£143.97
DECBT44*	W1200 x H1200mm	£171.01

Double Door

DECBT64*	W1800 x H1200mm	£251.61
DECBT84*	W2400 x H1200mm	£303.00

* Please specify colour when ordering

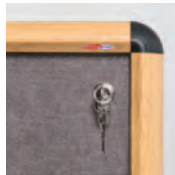

Please Specify:

Fabric colour

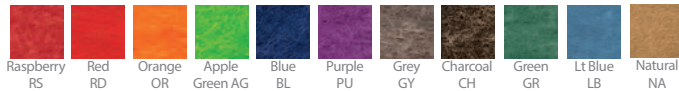

Non-returnable items, please report damages or discrepancies within 72 hours

Top Hinged Tamperproof EcoColour® Fire Resistant Noticeboards

- Top hinged lockable noticeboards with door supports
- Ideal for use in busy corridors
- Doors open upwards and are kept in place with support stays
- 2 locks per doors with matching keys
- Range of 11 standard colours

Single door

DE27301*	W900 x H600mm	£118.19
DE27302*	W900 x H900mm	£145.97
DE27303*	W900 x H1200mm	£157.93
DE27305*	W1200 x H900mm	£157.81
DE27304*	W1200 x H1200mm	£186.36

Double door

DE2736 *	W1800 x H900mm	£289.82
DE2738 *	W1800 x H1200mm	£313.47
DE2737 *	W2400 x H1200mm	£374.15

*Please specify colour when ordering.



Please Specify:

Fabric colour

EcoColour® Resist-a-Flame® Range

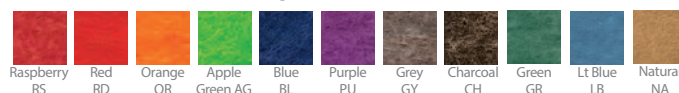

A

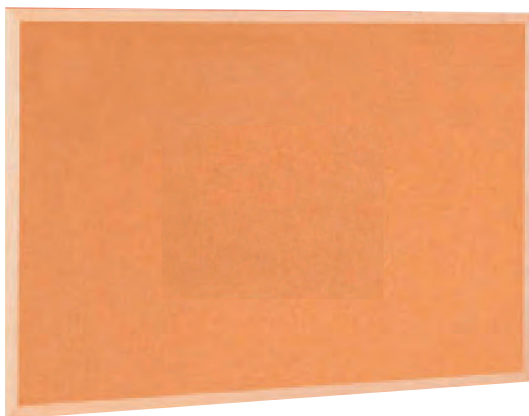

A Economy Cork Boards

- Lightweight double sided pin board
- Felt one side, cork on the other
- Supplied with fixings & free pins

F04071	600 x 900mm	each	£13.85
--------	-------------	------	--------

Non-returnable items, please report damages or discrepancies within 72 hours

B

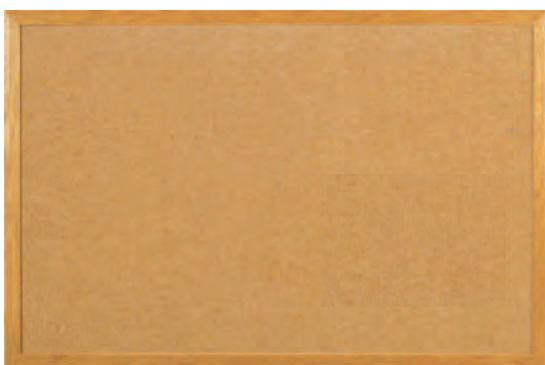

B Premium Cork Boards with MDF Frame

- Thick resilient cork for everyday use

MDFCK96	900 x 600mm	each	£27.47
MDFCK129	1200 x 900mm	each	£36.65
MDFCK1812	1800 x 1200mm	each	£53.96
MDFCK2412	2400 x 1200mm	each	£63.65

C

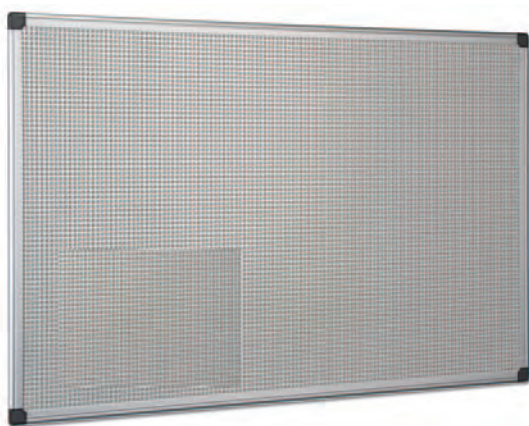

C Magnetic 'Pin Boards'

- Gridded metal over a grey cork notice board allows both pushpins, and magnets to be used
- Smart aluminium frame
- Hanging devices included
- Magnets and push pins included

42203	600 x 450mm	each	£39.57
42030	900 x 600mm	each	£57.93
42501	1200 x 900mm	each	£96.41



A Felt Noticeboards with Wooden MDF Frame

- Flame retardant felt to BS476 part 7 class 1
- All fabric is colourfast to BS1006
- Fixings pack included
- Available in Blue-BL Red-RD Green-GR Grey-GY Burgundy-BG

MDFFB96*	900 x 600mm	each	£31.72
MDFFB129*	1200 x 900mm	each	£44.67
MDFFB1812*	1800 x 1200mm	each	£72.10
MDFFB2412*	2400 x 1200mm	each	£96.01

*Please specify colour when ordering



A



Non-returnable items, please report damages or discrepancies within 72 hours

B Eco-Friendly Noticeboards

- Ever popular range offering an environmental choice at economical prices
- Almost entirely constructed from timber industry bi-products and recycled materials
- Attractive contoured 35mm wide frame is available in a choice of Light Oak (LO), Mahogany (MG) or Aluminium (AL) effect finishes
- Available in 5 popular felt colours: Blue (BL), Burgundy (BG), Green (GR), Grey (GY), Red (RD) or Traditional Cork (CK)
- Felt accepts both pins and Velcro®, cork option is pinnable

ECF96*	900 x 600mm	£25.42
ECF129*	1200 x 900mm	£34.72
ECF1212*	1200 x 1200mm	£39.53
ECF1512*	1500 x 1200mm	£53.43
ECF1812*	1800 x 1200mm	£62.03
ECF2412*	2400 x 1200mm	£78.62

* Please specify frame type and board colour when ordering



B

Frame Options

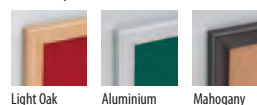

Please Specify:

1. Frame finish
2. Felt/fabric colour



CALL US ON 01527 878348



VISIT WWW.FORWARDPRODUCTS.CO.UK

A

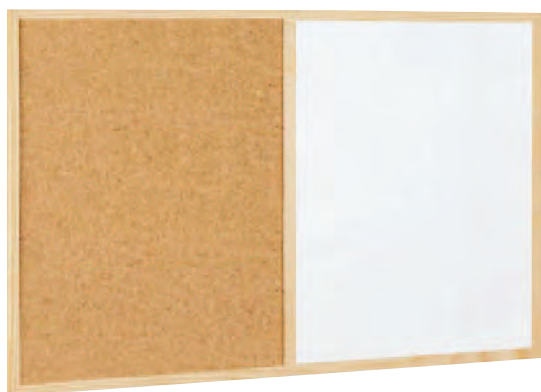

A Cork/Drywipe Boards

- Lightweight dual purpose boards
- Half drywipe and half cork pinboard surface
- Supplied with drywipe pen and pins

23010BQ	600 x 400mm	each	£5.86
27010BQ	900 x 600mm	each	£10.83



B



B Duo Felt/Whiteboards

- Twin surface boards offer the flexibility of both a dry-wipe whiteboard and a pinnable surface felt or cork noticeboard
- Drywipe surface is magnetic
- Felt surface accepts Velcro® as well as pins - colour fast to BS1006
- Available in 5 standard felt colours - Blue (BL), Burgundy (BG), Green (GR), Grey (GY) or Red (RD)
- Attractive anodised aluminium trim with concealed corner fixings (supplied)
- Made in UK

COMF32**	900 x 600mm	each	£26.32
COMF43**	1200 x 900mm	each	£38.12
COMF64**	1800 x 1200mm	each	£65.76

** Please specify colour when ordering

C



C Snap Display Poster Frames

- Attractive anodised aluminium frame
- Use to display information and signs
- Quick and easy to fit
- Clear plastic cover protects contents

SNFA4	A4	each	£13.91
SNFA3	A3	each	£18.62
SNFA2	A2	each	£20.88

D



D Photo & Certificate Frames

- Choose from smart black wooden frame or economical frameless version
- Non glass break resistant front
- Simple metal clips hold the contents in place, easy to open and insert display
- A4 black frame has back stand

F00400PHT	A4 Black Frame	each	£8.37
F00402PHT	A3 Black Frame	each	£10.26



Shield® Exterior Showcase Noticeboards

- Popular covered noticeboards that are designed to protect your information against the elements
- Truly weatherproof and meet the IP55 requirements of EN60529 for water and dust ingress
- Wall mounted units have top hinged doors with support stays and two matching locks
- Framework is available in anodised Aluminium as standard or powder coated in Black, Blue, Red, Green or White (POA)
- The internal display area is pinnable with a choice of 11 woven cloth colours, 6 contemporary felt colours, or cork
- Whiteboard insert also available on request (P.O.A.)
- Supplied complete with fixings
- A4 sheet capacities listed below



EXTL4**	575 x 712mm (A)	£158.49
EXTP4**	750 x 537mm (B)	£153.91
EXTL8**	750 x 967mm (C)	£199.83
EXTP8**	1050 x 752mm (D)	£200.46
EXTP12**	1050 x 1012mm (E)	£279.11
EXTP15**	1050 x 1182mm (F)	£305.96
EXTP18**	1050 x 1397mm (G)	£341.82

** Please specify felt colour & frame colour

A4 Sheet Capacities

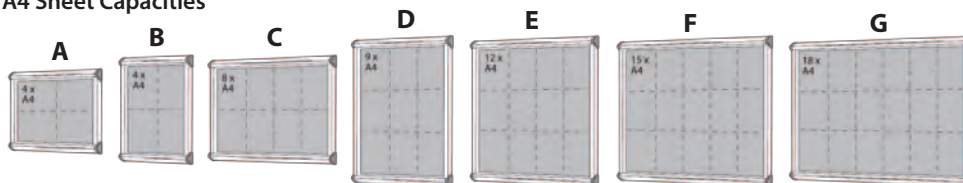

Please Specify:

Felt/fabric colour

Standard Felt Colours



Contemporary Felt Colours



Non-returnable items, please report damages or discrepancies within 72 hours



CALL US ON 01527 878348



VISIT WWW.FORWARDPRODUCTS.CO.UK

BusyFold® Light Display Kits

Lightweight folding panel system with 600 x 900mm PVC framed panels which are linked with flexible hinging and clip on top of each other.

- The 7 and 10 panel unit features triangular plinth/s for displaying 3D objects
- Double sided panels are covered in a choice of 14 loop nylon colours which are fire retardant to BS5867
- Accepts Velcro®
- All kits include headers and a carrying bag

** Please state frame and felt colour required
- frames available in grey or black

Non-returnable items, please report damages or discrepancies within 72 hours

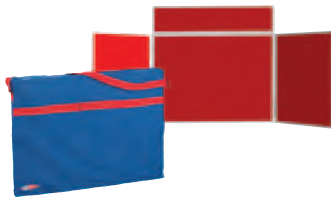

BusyFold Tabletop Landscape H x W

DBL3** 800 x 1800mm £76.10



BusyFold 6 Kit H x W

DB6** 2000 x 1800mm £163.45

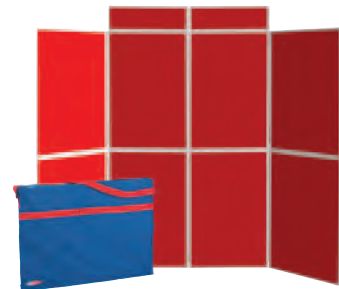

BusyFold 8 Kit H x W

DB8** 2000 x 2400mm £220.08



BusyFold Tabletop Portrait H x W

DB3P** 1100 x 1800mm £90.43



BusyFold 7 Kit H x W

DB7** 2000 x 1800mm £203.86

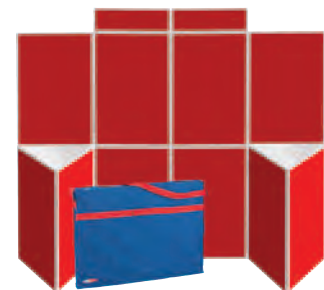

BusyFold 10 Kit H x W

DB10** 2000 x 2400mm £285.00

Please Specify:

Felt colour



08

FACILITIES AND HYGIENE

FIRST AID	255-262
TESTING EQUIPMENT	263-266
PPE	267-269
SIGNS & GRAPHICS	270-271
SANITISATION	272-278
CLEANING SUPPLIES	279-292
HAND TOWELS & DISPENSERS	293-294
TOILET ROLLS & FACIAL TISSUES	295-296
CATERING	297-299
TROLLEYS, LADDERS & KICK STOOLS	300-301
ROCK SALT	302





A British Standard First Aid Kits & Refills

- Large variety of contents suited to a school environment
- Contains high quality plasters that really stick!
- Weatherproof protective case

First Aid Kits

FBSKITS	Small 26 x 18 x 8cm	each	£22.19
FBSKITM	Medium 25 x 25 x 8cm	each	£32.45
FBSKITL	Large 36 x 25 x 9cm	each	£41.86

First Aid Kit Refills

- Variety of contents perfect for refilling a BS standard kit
- Easy and Cost effective way to ensure that you kits are up to date and organised

FBSRKS	BS Small Refill	each	£17.09
FBSRKM	BS Medium Refill	each	£26.24
FBSRKL	BS Large Refill	each	£33.86



B British Standard Travel First Aid Kit & Refill

- Variety of contents suited to a school bus/ school travel
- Contains high quality plasters that really stick!
- Weatherproof protective case

Travel First Aid Kit

FBSTRK	26 x 18 x 8cm	each	£30.62
--------	---------------	------	--------

Travel First Aid Kit Refill

- Easy and cost effective way to ensure that you kits are up to date and organised

FBSTRF		each	£9.36
--------	--	------	-------



A HSE First Aid Kits

- Variety of contents suited to a low risk area
- Contains high quality plasters that really stick!
- Weatherproof protective case

FHSEKS	10 Person Kit	26 x 18 x 8cm	each	£12.22
FHSEKM	20 Person Kit	25 x 25 x 8cm	each	£17.80
FHSEKL	50 Person Kit	36 x 25 x 9cm	each	£23.45

HSE First Aid Kit Refill

- Easy and cost effective way to ensure that you kits are up to date and organised

FHSERS	10 Person Refill	each	£8.28
FHSERM	20 Person Refill	each	£13.84
FHSERL	50 Person Refill	each	£17.76



B First Aid Wall Cabinets

- Sturdy, lockable, first aid metal wall cabinets supplied with internal shelves, first aid sticker, wall fixing points and 2 keys
- Keeps supplies safe and secure
- These units are supplied empty

Single Door 50 x 30 x 12 cm

11126	each	£38.04
-------	------	--------

Double Door 60 x 50 x 12.5 cm

11127	each	£69.25
-------	------	--------



B



A

A Activity Specific First Aid Kits

- Tough nylon showerproof construction
- Comprehensive fillings appropriate for use on school field trips, school sports injuries or in playgrounds

11189	Sports Kit In Haversack 34 x 22 x 22cm	each	£29.97
11125	Single Person Kit in Bum Bag	each	£8.89



B

B 10 Person First Aid Kit

- First aid kits in robust green cases
- HSE compliant filling

11123	10 Person	each	£11.44
-------	-----------	------	--------



C

C Eyewash Solutions & Cabinets

- Regulator Eyewash Cabinet In Neat Case provides smart unobtrusive easy solution
- Internal mirror for accurate application
- 2 x 500ml bottles and 2 x HSE Eyepads

FEWCAB	Cabinet 34 x 30 x 11cm	each	£26.85
11150	Eyewash 20ml	bx 25	£7.70
FEW500	Eyewash 500ml	each	£2.08



D

D Burn Treatments

Responder Medium Burns Kit

- Variety of contents suitable for treatment for scalds to small burns
- Containing only the highest quality of burns treatment products
- Weatherproof protective case

FBURNK	26 x 18 x 8cm	each	£31.91
--------	---------------	------	--------

Gel & Gel Dressing

- Sterile burns dressing suitable for scalds and small burns
- Excellent first aid for burns

11163	Pain Relief Gel 3.5g	pk 20	£7.80
11164	10 x 10cm Dressing	each	£3.06



A Premium Fabric Plasters

- Premium fabric dressing with extra strong adhesive
- Long wearing durable fabric plaster
- Latex free

11131G	Extra Wide Strip 75 x 25mm	bx 100	£4.70
11132L	75 x 50mm	pk 50	£4.50
11130	Assorted 6 Sizes	bx 100	£4.40
11133	38 x 38mm	pk 100	£3.99



A

B Washproof Plasters

- Premium plastic washproof dressing with extra strong adhesive
- Unique materials made to suit all general applications
- Latex free

11134	Assorted 6 Sizes	bx 100	£5.19
11137	33 x 38mm	pk 100	£3.74
11135	75 X 25mm	bx 100	£4.07
11135L	75 x 50mm	pk 50	£4.27
11139	Cartoon Strips 72 x 19mm	bx 100	£4.26



B

C Transparent Plasters

- Premium waterproof dressing with extra strong adhesive
- Aesthetic film blending with every skin colour
- Latex free

11209	Assorted 6 Sizes	bx 100	£4.48
11213	38 x 38mm	pk 100	£4.11
11211	75 x 25mm	bx 100	£4.35
11210	75 x 50mm	pk 50	£3.75



C

D Island Dressings

- Ideal dressing for large wounds and abrasions
- Large non adherent wound pad
- Latex free

11140	Sterile 8 x 10cm	bx 50	£14.58
-------	------------------	-------	--------



D

E Triangular Bandages & Safety Pins

- Premium re-usable and washable cotton calico triangular bandage
- Superior quality materials
- Safety pins are nickel plated and supplied in 3 assorted sizes

11144	Triangular Bandage 90 x 90 x 127cm	wrap 10	£7.40
11178	Safety Pins	pk 12	£0.97



E

A



A Hot & Cold Treatments

Instant Ice Pack

- Premium quality instant ice pack which are ready for immediate use in need of emergency cold therapy
- Packaged in a durable wrap

11159A	240g 23.5 x 12	wrap 5	£5.26
--------	-------------------	--------	-------

Hot/Cold Pack With Cotton Cover

- Premium Hot & Cold pack designed to quickly reduce swelling and alleviate pain
- Can be heated in microwave or chilled in a freezer before use

11159B	29 x 12	each	£3.88
--------	---------	------	-------

B



B Cleansing Wipes

Sterile Saline Wipes

- Premium Saline Cleansing wipe for gentle application around cuts and grazes, 0.9% sodium chloride

11148	10 x 8cm	box 100	£6.14
-------	----------	---------	-------

Alcohol-Based Hard Surface Wipes

- Premium Hard Surface wipe for effective bacterial action against minor organisms on hard surfaces, not for use on skin

11216	22 x 20cm	tub 200	£5.64
-------	-----------	---------	-------

NEW!

C



C Bio Productions Sanitaire Shakers 240g

- This absorbent powder is the market leading clean-up powder, with its subtle floral fragrance and germicidal action it has been specially formulated for use in all emergency situations where body spills occur
- Sanitaire's fast acting absorbent powder helps prevent the spread of airborne germs and odours while also helping to prevent soiling being absorbed deeper into upholstery fabrics and floor-coverings
- Economical to use, Sanitaire is an effective emergency treatment for all accidental spillage's including vomit, urine, blood and faeces as well as for cleaning-up food and drink spillages
- Sanitaire absorbs up to 200 times its own volume weight

F09-406	each	£6.75
---------	------	-------



A Body Spill Kit - Single Application

- Designed for the safe collection and disposal of blood and blood-stained body fluid spills

BSK1 £4.99



A

B Body Spill Kit Set

- 25 Applications
- Ideal for responding to body spills
- Contents: bucket, hand scraper, dustpan, 2xsanitaire shakers, windmill eliminator max (750ml), 100x supersized clinical wipes, 100x gloves, 200x aprons, 25x biohazard sacks and an instruction chart

BSK25 £64.95



B

C Body Spills Consumables

Responder 2 Application Body Spills Kit

Variety of contents suitable for treatment of body spills

- Containing only the highest quality body spills clean up consumables
- Weatherproof protective case

11169 26 x 18 x 8cm each £20.86

Sick Bags (Poly Lined)

- Poly lined vomit bags

11170 23 x 13.5cm pk 10 £2.99



C

D Disposable Sick Bowls

- Disposable pulp general purpose bowl
- Made from recycled and disposable material with added waterproofing

CW128 pk 200 £34.99



D

E CPR Protection & Prep Kit

- Yellow body spills waste bag
- Disposable plastic apron
- Pair of vinyl gloves
- Supplied in gripseal bag

Personal Protection Pack In Polygrip Bag

11175 14 x 14cm each £0.84



E

A

**A Forehead Strip Thermometer**

- Liquid crystal thermometer estimates core body temperature
- Unbreakable, quick reading

11220	100mm	each	£2.57
-------	-------	------	-------

B

**B Accident Record Book**

- Comprehensive accident record book suitable for recording workplace injuries
- A4, 50 pages

11177		each	£4.40
-------	--	------	-------

C

**C Adhesive Sterile Dressings**

- Individually wrapped and sterile
- 60 x 80 mm

11143		pk 50	£11.41
-------	--	-------	--------

D

**D Conforming Bandages**

- High quality, cost effective bandage with excellent conforming qualities
- Lightweight, durable & suitable for bandage retention
- 25mm x 4m rolls

11197		pk 12	£3.10
-------	--	-------	-------

E

**E Low Adherent Dressings**

- Double sided 50 x 50mm pads
- These dressings have a special non-adherent film on both sides of the pad to minimise trauma to the wound from sticking

11201		pk 50	£6.72
-------	--	-------	-------



A Sterile Low Adhesive Dressings

- Sterile general purpose dressings
- Highly absorbent, non adherent pads attached to non-conforming bandages

11141 120 x 120mm pk 12 £4.68



A

B Cotton Wool

- Highly absorbent finest quality cotton wool products
- 500g bulk pack

11182 each £6.07



B

C Sterile Moist Cleansing Wipes

- Alcohol free cleansing wipes for removal of dirt and debris from minor skin abrasions prior to the application of dressings
- Individually wrapped to comply with regulations

11148 10 x 8cm pk 100 £6.14



C

D Microporous Tape

- Hypo-allergenic tape in bulk value packs
- Flexible, permeable to air & moisture vapour

11147 25mm x 10m pk 12 £11.89

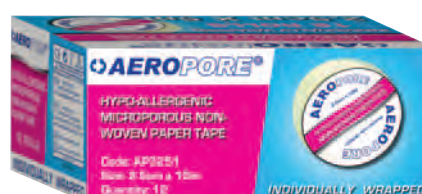

D



Swab procedure posters and sanitary equipment illustrated in the document not supplied.

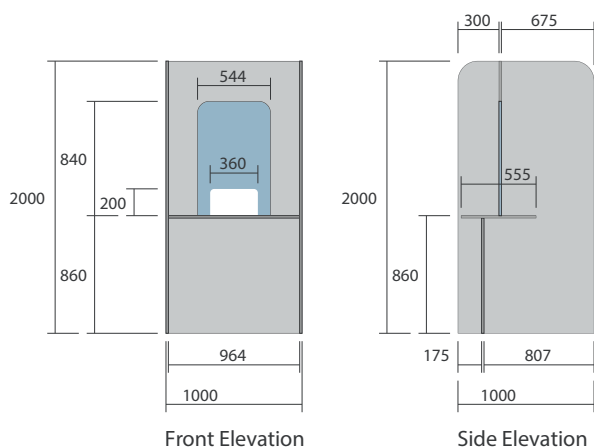
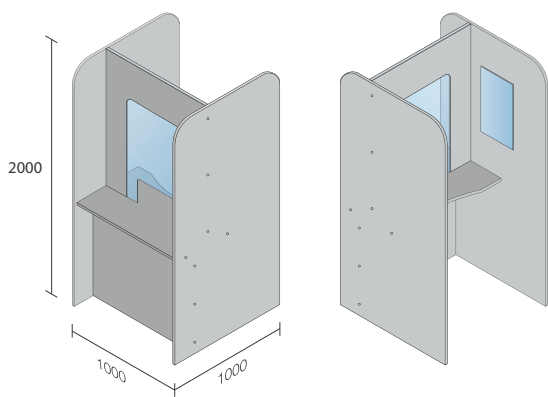

A. COVID Testing Pods - Grey

- Our Freestanding COVID Testing Pods provide a discreet and efficient area for staff and students and are designed to achieve a comfortable area while performing RNA tests
- Made from heavy duty MFC, they are both sturdy, practical and aesthetically pleasing, quick to install and can be easily moved around in your testing area as requirements evolve
- The acrylic safety screen has a cut out slot 200mm high x 360mm wide, which is large enough to post a test tube through inside a holder
- Mirror included for a participant to observe their RNA swab procedure
- 1000 x 1000 x H2000mm

	1-4	5-9	10+
CP1001	£577.23	£548.49	£498.49

- Our Covid Testing Pod can also be purchased with fitted locking castors so that you can easily move the pod around to different areas

CP1011	Testing Pod with Locking Castors	£672.23
--------	----------------------------------	---------





Singular Covid Testing Booth Starter Module

- Create a safe and user friendly Covid testing area with our freestanding, modular COVID Testing Booths
- DDA Compliant design
- Choose from standalone or linking add-on modules – with two different size options for greater flexibility and DDA wheelchair access
- The simplicity of add-on modules allows them to be quickly assembled or disassembled when not required
- Supplied with a mirror, built in table top, and an acrylic safety screen with a 200mm high x 360mm wide cut out slot which is large enough to post a completed Covid test through inside a holder
- The booths streamline the whole Covid testing process, helping to cut down the time spent on each test and to improve safety
- Made from heavy duty MFC in a durable white finish, the booths are sturdy, practical and aesthetically pleasing and can be repeatedly sanitised using sprays, wipes or fogging machines
- Delivery within 2-3 weeks of ordering to mainland UK - call for a quote on installation, or for deliveries outside of mainland UK

All prices on pages 263-278 may fluctuate



CP2001	W1250 x D2425 x H2000mm	£761.85
--------	-------------------------	---------

Add-on Module

CP2002	W1250 x D2425 x H2000mm	£684.92
--------	-------------------------	---------

Fully Accessible Covid Testing Booth Starter Module

CP2003	W2475 x D2450 x H2000mm	£992.62
--------	-------------------------	---------

Add-on Module

CP2004	W2450 x D2450 x H2000mm	£915.69
--------	-------------------------	---------





A

A Mobile Medical Floor Standing Privacy Screen - White

- Free-standing mobile privacy screen
- Additional screens can be linked via a linking hinge
- Supplied with two individual locking castors
- Steel frame surrounds and leg supports MDF screen providing an acoustic barrier
- Screens can be nested when not in use to save space
- 100% recyclable and easily cleaned
- W1000 x H1900mm

MFSPS	£246.15
-------	---------



B



B Opaque Health Screen

- Our opaque healthcare screens are easy to assemble, hygienic and low maintenance making them ideal for COVID testing areas
- The top and bottom panels are made from easy clean opaque Akare material
- The sturdy steel frame and H base plates are powder-coated in matt black
- Supplied as a flat pack – 20 mins assembly time
- Black steel frame

SCR750	H1850 x W750mm	£199.00
SCR1500	H1850 x W1500mm	£279.00

All prices on pages 263-278 may fluctuate

C



C Retractable Barrier Black Frame/Black Belt

- Ideal for channelling queues
- 2.5m long and connects into position with a 4-way safety button
- For indoor use
- £25 delivery charge

RB25	each	£34.29
------	------	--------



A SARS COV2 Rapid Antigen Test

- Professional COVID 19 Rapid Antigen Test Kits from Roche Diagnostics Limited, for quick and reliable results
- This test is intended to detect antigen from the SARS-CoV2 virus in individuals suspected of COVID-19
- 15 minute result time
- Overall relative sensitivity of 95.5% and a relative specificity of 99.2%
- Kit includes: Test device, extraction buffer tube, nozzle cap, sterile swab, film (can be attached to the test device when performing outdoor testing), instructions for use and quick reference guide

CVTST pk 25 £195.00



A

B Digital Magnetic Countdown Timer

DCT30 each £7.99



B

All prices on pages 263-278 may fluctuate

C Kidney Dish Blue Plastic

- Ideal for holding testing swabs
- 150mm dish size

PC01720 each £3.00



C

D Square Wall Mirror

- 40x 40cm

SWM5 pk 5 £52.95



D

E Table Top Mirror Freestanding

TTMF each £4.95



E

A

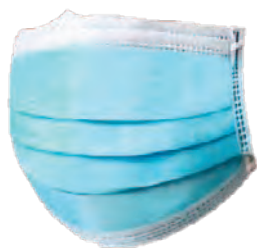

A Disposable Face Masks Type IIR Blue

- Disposable non-woven face masks with ear loop
- 3-ply with inner layer

		1-9	10+
B3PDFM50	pk 50	£9.95	£7.25

B

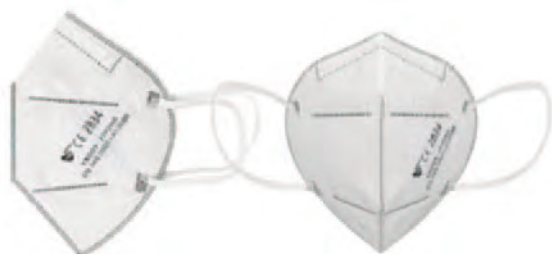

B FFP2 / KN95 (Non-Valve) Masks

- FFP2 / KN95 (Non-Valve) Masks
- EN 149:2001+A1:2009
- FFP2 face masks are the equivalent of N95 face masks, which meet the guidelines from The World Health Organisation for protection against Covid-19

FFP2-30	pk 30	£31.19
---------	-------	--------

C



C FFP3 Valved Dolomite Fold Flat Respirator

- CE-CAT III EN149:2001+A1:2009
- Flexible shape which allows the mask to be folded flat
- High performance exhalation valve to reduce heat and provide comfort when used in hot and humid conditions, ideal for all day use
- Elastic strap
- Individually wrapped inside hygienic polybag

F22-P351	pk 20	£61.35
----------	-------	--------

All prices on pages 263-278 may fluctuate

D



D Full Face Visor

- High transparency face shield with a wipe clean surface
- Weighs only 25g and is comfortable to wear
- 100% PVC free

BMVFS	each	£2.85
-------	------	-------

E



E BlueOcean Safety Spectacles

- Safety spectacles ideal to protect eyes from infections
- Can fit comfortably over most spectacles and has a moulded-in browguard for extra protection
- Conforms to EN 166-2002-04

BSS	each	£2.67
-----	------	-------

F



F Professional Infrared Forehead Thermometer

- Simple to use infrared forehead thermometer
- Contactless measurement which can quickly and accurately measure body temperature

PIFT	each	£39.99
------	------	--------



A Vinyl Powder Free Gloves

- Smooth, soft finish latex free gloves
- Conforms to EN 455-1/2/3/4 and AQL 1.5

			1-9	10+
VGLMED	Medium	pk 100	£8.75	£7.50
VGLLRG	Large	pk 100	£8.75	£7.50



A

B Synthetic Powder Free Medium Gloves

- A unique blend of Nitrile and Vinyl with superior fit and strength
- Softer, more flexible and greater sensitivity than Nitrile or Vinyl, performance similar to Latex
- Micro textured for excellent wet or dry grip
- Latex-free, powder-free

F22-950M	Medium	pk 100	£12.62
F22-950L	Large	pk 100	£12.62



B

All prices on pages 263-278 may fluctuate

C Latex Gloves

- Quality medical grade latex gloves in bulk boxes
- Available powdered or powder-free

Powder Free

11152	Medium	pk 100	£9.95
11153	Large	pk 100	£9.95

Powdered

11155	Medium	pk 100	£9.95
-------	--------	--------	-------



C

D Disposable Vinyl Gloves

- Bulk pack of 100 gloves in a dispenser box
- Available in medium or large sizes

10400	Medium	pk 100	£9.10
10865	Large	pk 100	£9.10



D

E Latex Free Nitrile Gloves - Blue

- Nitrile rubber gloves gives better puncture and abrasion resistance and excellent wet and dry grip
- Feels cooler than latex and is comfortable and flexible

GLOVESBLMED	Medium	pk 100	£16.99
GLOVESBLLRG	Large	pk 100	£16.99



E



CALL US ON 01527 878348



VISIT WWW.FORWARDPRODUCTS.CO.UK

All prices on pages 263-278 may fluctuate

B



A



A Disposable Aprons White

- 16 Micron
- Disposable white aprons for a variety of uses
- 16 micron thick, 46 inch length

WAFP1011 pk 1000 £49.99

B White Apron on Roll

- 16 micron aprons which provide a high level of protection and hygiene across many industries
- Integrated head hole and waist band ensure a secure fit

F22-220W roll 200 £7.38

C



C Antibacterial Wet Wipes

- Pack of 80 wipes for hygienic protection on surfaces
- Resealable packets to keep the wipes at their best
- Kills 99.9% of bacteria
- 15x17cm

AWW80 1-29 30+
pk 80 £2.99 £2.59

D



D Uniwipe Clinical Midi Wipes

- Super-soft, strong and absorbant wipes that are safe to use on all surfaces and hands
- Sanitising efficiency EN1276, EN13727 and EN14476
- Effective against Norovirus, MRSA and H1N1
- Trusted in healthcare organisations

UCMW200 pk 200 £6.75

E



E Grey Metal Uniwipe Tray for Wall Mounting

- Tough dark grey metal holder for clinical uniwipes
- For wall mounted with with Keyhole fixing holes
- Great for mounting in offices or communal areas to encourage their use and keep them off work surfaces

F28-223 each £16.48

F



F Eliminator High Performance Disinfectant Wipes

- Surface sanitising wipes
- Conforms to EN1276, EN13697, EN1650, EN14476

F02-600	Bucket of 1000	£18.65
F02-650	Refill bag 1000	£16.67
F02-550	Bucket of 2000	£25.21



A Floor Graphics - School Feet - Carpet Grade

- The stickers are manufactured from durable non-slip vinyl and are suitable for short term use on short pile carpet and carpet tiles
- They will need replacement regularly in high traffic areas
- Floor graphic size is 280mm diameter and comes in a pack of 5

SDP0197 pk 5 £34.05



A

B Floor Graphics - School Social Distancing - Carpet Grade

- The stickers are manufactured from durable non-slip vinyl and are suitable for short term use on short pile carpet and carpet tiles
- They will need replacement regularly in high traffic areas
- Floor graphic size is 280mm diameter and comes in a pack of 5

SDP0198 pk 5 £34.05



B

C BlueOcean 'Please Keep A Safe Distance' Tape

- Self-adhesive tape for marking out borders in corridors, reception and other areas
- Wording on tape: 'Please Keep A Safe Distance'
- Tape size: 48mm x 66m

BPKSD each £6.99



C

All prices on pages 263-278 may fluctuate

D Hazard Tape Black/Yellow Self-Adhesive

- Constructed from heavy-duty PVC material and backed with an aggressive high grab adhesive
- Scuff resistant and highly visible
- Tape size: 48mm x 33m

HZDTPE each £4.99

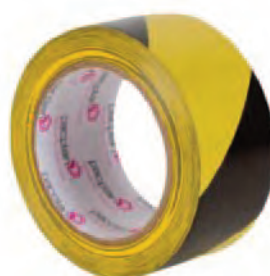

D

A



A Pull up Banner - Schools and Nurseries

- The pull-up banner is an easy to assemble, sturdy design which effectively communicates social distancing guidelines in any professional environment
- Banner visual area size: 800mm x 2000mm

SDP0185 each £62.00

All prices on pages 263-278 may fluctuate

B



B A4 Handwashing Instructions - Self Adhesive Vinyl Yellow

- The self-adhesive vinyl sticker effectively communicates correct handwashing techniques which can help reduce the spread of COVID-19
- It is easy to apply and keep clean
- Size is A4 and comes in a pack of 5

SDP0149 pk 5 £15.26

C



C Yellow Folding Safety Sign - 'Wet Floor/Cleaning in Progress'

- All plastic heavy-duty sign, folds flat for easy carrying and transportation
- Vivid bright yellow with eye-catching red and black signage printed both sides "Wet Floor" on one side, "Cleaning in Progress" on the reverse

F15-601 each £5.08



A Hand Sanitiser 60ml

- Kills 99.9% of bacteria
- Fast drying formula
- Non-sticky

HSAN60* each £0.50

*While stocks last



REDUCED TO CLEAR

A

B Instant Hand Sanitiser

- 70% alcohol content for effective sanitising
- Specially formulated with added moisturiser for frequent use
- Brand may vary

		1-23	24+
HR52114	500ml	£3.95	£2.95

		1-9	10+
HR52119	5 litre	£24.99	£19.99

B



C Windmill Alcohol Hand Sanitiser

- 70%+ Alcohol sanitiser
- Conforms to EN1276
- Pocket sized bottle with flip top

F10-211 100ml £0.86

C



All prices on pages 263-278 may fluctuate

D Alcohol-Free Hand Sanitiser

- Alcohol-free hand sanitiser
- Conforms to EN1276, EN1500, EN1476, EN13704

F10-213 2 x 5 litre £39.16

F10-214 6 x 500ml £31.19

D



E Alcohol Hand Sanitiser With Clip

- Easy and convenient to use - can clip to lanyards, pockets etc
- Pump action dispenser
- Around 70% alcohol content

F10-238 18 x 50ml £33.45

E



CALL US ON 01527 878348



VISIT WWW.FORWARDPRODUCTS.CO.UK

A



A Windmill Antibacterial Hand Soap

- White antibacterial hand soap
- Unperfumed - can be used in catering environments
- 6 x 450ml with pump tops

F10-203	6 x 450ml	£11.90
---------	-----------	--------

B



All prices on pages 263-278 may fluctuate

B Pump Top Liquid Hand Soap

- Contains 24 x 400ml hand soap with an orchid flower scent

PTLHS400	24 x 400ml	£44.95
----------	------------	--------

C



C Windmill Antibacterial White Hand Soap

- Suitable for environments such as hospitals and kitchens where hygiene is essential
- Perfect for use in refillable dispensers

WAHS5	5 litre	£5.75
-------	---------	-------

D



D Dyma Liquid Hand Soap

- Moisturising hand soaps
- Suitable for sensitive skin

HSOAP5	5 Litre	each	£7.89
--------	---------	------	-------



A Windmill Skin Barrier Cream Unperfumed

- Quality skin barrier cream for use before or after work
- Unperfumed suitable for use in catering areas
- Fast and effective

F10-855	5 litre	£16.44
---------	---------	--------



A

All prices on pages 263-278 may fluctuate

B Windmill Skin Reconditioner Perfumed

- Quality skin reconditioning cream
- Fast and effective
- Pleasant fragrance

F10-850	5 litre	£19.54
---------	---------	--------



B

C Touch Hand Care Dispenser

- Dispenser to fit any of the 1 Litre Touch cartridge range
- Dispenser is FOC when cartridges are brought with the dispenser
- 1250 pumps per cartridge

F28-800	Dispenser	each	£8.73
---------	-----------	------	-------



C

Anti Bacterial Fragrance Free Foaming Hand Soap

F10-815	1L Cartridge	£7.73
---------	--------------	-------

Alcohol Free Hand Sanitiser

F10-825	1L Cartridge	£7.71
---------	--------------	-------

Skin Barrier Cream, Unperfumed

F10-835	1L Cartridge	£12.17
---------	--------------	--------

Revive Skin Reconditioner Perfumed

F10-830	1L Cartridge	£14.40
---------	--------------	--------

Sanitise Alcohol Hand Sanitiser

F10-820	1L Cartridge	£11.33
---------	--------------	--------

Wash Hair & Body Wash

F10-811	1L Cartridge	£7.73
---------	--------------	-------



A



All prices on pages 263-278 may fluctuate

B



C



D



E



A Manual Refillable Dispenser

- Plastic bulk fill dispenser with a 1litre or 500ml capacity
- Suitable for standard liquid hand soap, antibacterial soap and alcohol hand sanitiser

WMD28-249	500ml	each	£14.95
WMD28-250	1 Litre	each	£16.95

B Refillable Soap Dispenser

- Suitable for standard liquid hand soap, antibacterial soap and alcohol hand sanitiser
- 500 dispenses per fill

RSD100	1 Litre	each	£16.95
--------	---------	------	--------

C Manual Refillable Dispenser

- High quality plastic wall-mounted bulk fill dispenser with a 1L capacity
- Detachable refill container with lid 1ml Pump which gives 1000 dispenses per fill

Complete with label for 'Antibacterial Hand Soap'

F28-251	1 Litre	each	£18.17
---------	---------	------	--------

Complete with label for 'Hand Cream'

F28-252	1 Litre	each	£18.17
---------	---------	------	--------

D Refillable Dispenser (Transparent)

- 1 Litre sanitiser/ soap dispenser
- Comes with wall plate and fixings

F28-500	1 Litre	each	£9.44
---------	---------	------	-------

E Infrared Wall Mounted Automatic Alcohol Hand Sanitiser Dispenser

- Easy to clean wall mounted automatic alcohol hand sanitiser dispenser with a 1L capacity
- Automatically dispenses when hands are detected underneath
- Battery operated (4x C type batteries).

WMD28-244	1 Litre	each	£53.99
-----------	---------	------	--------



A Wall Mounted Automatic Hand Sanitiser Dispenser with Drip Tray

- 1L Automatic refillable dispenser with tough metal backboard and drip tray
- 'Clean Hands Save Lives' message board above dispenser
- For wall-mounting - simply fix dispenser through pre-drilled backboard into the wall
- Completely touch-free operation
- Sold ready to use including 4x C batteries and fixings

F28-242 1 Litre each £90.95



All prices on pages 263-278 may fluctuate

A

B Counter Top Automatic Hand Sanitiser Dispenser

- 1.2L Automatic refillable dispenser mounted to tough metal countertop stand and drip tray
- 'Clean Hands Save Lives' message board above dispenser
- Smart solution for entrance areas and reception desks
- Completely touch-free operation
- Sold assembled and ready to use including 4 x C batteries

F28-249 1.2 Litre each £117.46



B

C Manual Refillable Dispenser Complete with Fence Mounted Dispenser Backplate

- High quality manual 1L refillable dispenser
- Tough grey metal backplate with 4 cable tie fixings and message board above
- Great for fixing dispensers to fences and outdoor spaces, ideal for outdoor sports facilities
- Comes complete with cable ties

F28-256 1 Litre each £46.43



C

D Touch Antibacterial Door Pushpad

- The touch door pushpad is engineered to kill germs in seconds
- Alternative silver & plastic based products can take many hours to achieve a similar germ kill level
- Pushpads mode of action mimics the effect of disinfecting the surface with an antibacterial wipe after every contact, helping to prevent the spread of infection
- Includes 12 Plastic Mounts and 60 Refills

TADP1260 £499.00



D

A



All prices on pages 263-278 may fluctuate

A Eliminator Aerosol Fogger - High Performance 200ml

- Room sanitising aerosol - place in centre of room, push down cap and sanitiser is fogged into the room
- Allow to work for 15 minutes, and ventilate room for a further 15 minutes
- Each can covers up to 100m³
- Contains over 90% alcohol
- Bactericidal, viricidal and fungicidal EN1276, EN14476 and EN1650

F06-865 each £7.92

B



B Windmill Eliminator Max Electrostatic Sanitising Kit

- Battery powered electrostatic sprayer which charges a very fine mist to give surfaces an even coating
- Electrostatic spray gives 360 degree covering
- Kit includes 18V Battery Electrostatic Spraying Machine, Battery, Charger, 3x Nozzles, Kit Box, 2x5L of Windmill Eliminator Max, Dosing Pump and Chart

F16-820 each £865.08

C



C Pressure Sprayer c/w Eliminator Max Label

- Heavy duty professional sprayer which is comfortable and easy to use
- 370 x 190mm with a 5L capacity

PSEH5 each £34.60

D



D VIVID-5 Viricidal Solution - 5 Litre

- 5L viricidal solution for use with the VIVID portable fogger (product PF220)

PF5L £39.00

E



E VIVID Portable ULV Sanitising Fogger

- A portable fogger designed for fast and effective deep cleaning
- Liquid is atomised to create a very fine fog which binds to surfaces to disinfect on contact
- Multiple spray nozzles produce different size droplets for various applications

PF220 each £915.00



A Outdoor Dispenser Stand on Wheels

- Heavy Duty Free Standing Alcohol Hand Sanitiser Dispenser on wheels, suitable for indoor and outdoor
- Bold design to encourage use of sanitiser
- Great for school entrances
- Bulk fill manual dispenser for hand sanitiser
- 100 litre storage capacity in base - works best with some weight in base for stability - storage can be padlocked and around 3-4x5L bottles is enough to give it stability
- Angled lid allows water to run off
- Solid 200mm rubber wheels on back of unit make moving easy
- Large 'Clean Hands Save Lives' backboard sign
- Easy to clean
- 3 ground anchor points in the base
- Stand is made from fully recyclable, chemical resistant, UV stabilised MDPE
- Floor base is W700 x D600 x H1275mm
- Available single or double-sided

F28-260	Single Sided	£561.67
F28-262	Double Sided	£695.97



B Alcohol Hand Sanitiser Dispenser Free Standing With Drip Tray

- Freestanding alcohol hand sanitiser dispenser with drip tray
- Excellent for placing in entrance areas to promote sanitising on entry to buildings
- Includes free of charge 5L tub of hand sanitiser
- 1370mm high overall, base is 330 x 330mm

AHSDFS1	£295.00
---------	---------

All prices on pages 263-278 may fluctuate



C Foot Activated Hand Sanitiser Dispenser

- Popular hands-free dispenser with foot operation
- Excellent for placing in entrance areas to promote sanitising hands on entry to buildings
- Suitable for indoor and outdoor use
- Adapts to all stand pump bottles
- Supplied empty
- Pump top and sanitiser must be purchased when buying the dispenser

IL12008	Dispenser	each	£289.00
IL12009	Pump Top	each	£11.79
IL12012	Sanitiser Gel	1 Litre	£6.95

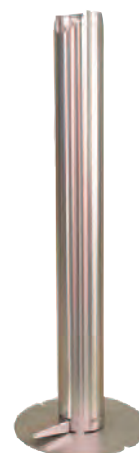

A



A Windmill Invincible Screen Printed Trigger Spray (Empty)

- Label is printed directly to the bottle
- Removes risk of unlabelled trigger spray bottles
- Reduce single use plastics with these quality re-usable bottles
- Available with 5 colour trigger options for colour-coding

F14-750IB	Blue	750ml	£1.59
F14-750IG	Green	750ml	£1.59
F14-750IR	Red	750ml	£1.59
F14-750IW	White	750ml	£1.59
F14-750IY	Yellow	750ml	£1.59

B



B Trigger Spray Complete White (Empty)

- Adjustable spray pattern from a fine spray to jet

TSCW750ML	750ml	£1.50
-----------	-------	-------

C



C Dosing Pump

- Standard dosing pump for accurate 30ml (1fl.oz.) delivery of a wide variety of highly viscous products such as waxes and cleaning chemicals
- Lock-down pump head provides leak-proof shipment of product with pump in-situ
- Standard closure 38/40mm
- Polypropylene with stainless steel spring valve

F14-700	30ml	each	£2.29
---------	------	------	-------



A Windmill Invincible - Cleaner Disinfectant

- Perfumed sanitiser effective against enveloped viruses
- Certified against H1N1, MRSA, common food poisoning bacteria, Swine Flu, HIV, Hep. C & MRSA
- EN1276, EN14476
- Bleach-free, alcohol-free solution
- 5 Litre concentrate dilutes 1:10 into trigger spray for infection control, or 1:40 for floor cleaning
- 750ml bottle is ready to use

F05-281	750ml Ready To Use	£2.37
F05-280	5 Litre Concentrate	£7.86



A

B Windmill Eliminator Max - Extreme Performance Sanitiser

- Cleans and sanitises frequently touched items
- Suitable for catering environments. Proven to kill Norovirus, E.Coli, Swine Flu, HIV, Hepatitis C, MRSA

WEM750ML	750ml Ready To Use	£4.95
WEM5L	5 Litre Concentrate	£14.65



B

C Windmill Captain Pine - Hard Surface Cleaner

- All purpose cleaning concentrate, ideal for removing soil, grease and heel marks from all synthetic floors- also excels on all non-porous surfaces
- Controlled foam helps prevent over use
- For cleaning floors in offices, schools, hospitals, canteens etc.
- Suitable for use on linoleum, PVC, rubber, sealed wood, sealed cork and thermoplastic floors
- N.B. Not recommended for galvanised surfaces, laminated flooring or unsealed wood and cork

F06-585	5 Litre	£5.63
---------	---------	-------



C

D Windmill Lemon Gel

- Versatile multi-purpose cleaning gel for polished floor cleaning
- Removes general soiling from a variety of hard surfaces including vinyl, rubber, terrazzo, polished and sealed surfaces
- Pleasant lemon fragrance
- Can be used for spray cleaning a polished floor and buffed to a high gloss finish
- Not suitable for use on safety flooring

F03-326	5 Litre	£6.62
---------	---------	-------



D



A



A Windmill Gleam Plus - Glass Cleaner With Vinegar

- Contains vinegar to aid grease cut
- Advanced formula ensures a smear-free finish
- Free from abrasives – will not damage delicate surfaces
- Ammonia free – pleasant and easy to use
- Simply spray on and wipe off for a sparkling finish
- Fast spray and wipe window cleaner
- Contains anti-misting agent

F06-283	5 Litre	£6.59
F06-282	750ml	£1.89

B



B D-Solve Liquid Graffiti Remover

- Powerful fast acting formula
- Water soluble-simply wash off with water
- Low viscosity ensures quick penetration
- Low odour, no choking fumes

F06-T070	each	£11.24
----------	------	--------

C



C Windmill Lustre - Luxury Multi-Purpose Furniture Polish

- A superior spray polish for furniture, tiles, marble, stainless steel and most plastic and vinyl coated surfaces
- Removes finger marks and surface dirt and produces a glowing finish
- Eliminates vigorous polishing but brings up a brilliant, protective, long lasting shine
- Highly concentrated silicone formulation for economy in use
- Pleasant waxy lavender perfume

F06-181	750ml	£2.41
---------	-------	-------

D



D Windmill Odour Force Lemon - Enzyme Deodoriser

- Enzymatic action, natural and effective odour eliminator
- Breaks down organic soiling and stains
- Powerful citrus scent
- Ideal for washrooms and use on carpets
- Safe for use on all types of absorbent surfaces
- Kit contains: 2 x Windmill Odour Force Lemon 5L, 1 x 5L Pressure Sprayer, 4 x Windmill Odour Force Lemon Trigger Bottle Labels and A3 Instruction Chart

F05-860	5 Litre	£19.81
F05-OMLK	Windmill Odour Force Kit	£84.27



A Windmill Carpex - Low Foam Extraction Carpet Cleaner

- Carpex is a specially formulated cleaner suitable for woven and non-woven carpets of synthetic and natural fibres when used in conjunction with a water extraction machine
- Rapid dirt removal
- Suitable for all makes of hot/cold water extraction machine
- Low foam for ease of pick up

F09-800 £6.62



A

B Dyma Liquid Hand Soap

- Moisturising hand soaps
- Suitable for sensitive skin

HSOAP5 5 Litre each £7.89



B

C Windmill Antibacterial Hand Soap

- White antibacterial hand soap
- Unperfumed - can be used in catering environments
- 6 x 450ml with pump tops

F10-203 6 x 450ml £11.90



C

D Pump Top Liquid Hand Soap

- Contains 24 x 400ml hand soap with an orchid flower scent

PTLHS400 24 x 400ml £44.95



D

E Windmill Antibacterial White Hand Soap

- Suitable for environments such as hospitals and kitchens where hygiene is essential
- Perfect for use in refillable dispensers

WAHS5 5 Litre £5.75



E



A

A Multi-Purpose Cloths

- Optima heavy duty cloths are strong and highly absorbent
- Machine washable

F12-054B	Blue	pk 25	£4.78
F12-054G	Green	pk 25	£4.78
F12-054R	Red	pk 25	£4.78
F12-054Y	Yellow	pk 25	£4.78



B

B All Purpose Cloths

- 480 x 355mm cleaning cloths
- Perfect in the kitchen or office

F00634	pk 50	£5.34
--------	-------	-------



C

C All Purpose Cloth on a Roll

- All purpose disposable cloths for infection control
- Colour coded in 4 colours
- Over 100m of perforated cloth per roll

F12-500B	Blue	each	£11.19
F12-500G	Green	each	£11.19
F12-500R	Red	each	£11.19
F12-500Y	Yellow	each	£11.19



D

D All Purpose Cloths

- Professional quality all purpose cloths, for wet use

APCB50	Blue	pk 50	£2.85
APCG50	Green	pk 50	£2.85
APCR50	Red	pk 50	£2.85
APCY50	Yellow	pk 50	£2.85



E

E Microfibre Cloth

- Absorbs dirt, dust and spills on any hard surface and can be used dry or damp

MCB10	Blue	pk 10	£5.00
MCG10	Green	pk 10	£5.00
MCR10	Red	pk 10	£5.00
MCY10	Yellow	pk 10	£5.00



F

F Microfibre Cloths

- Absorbs dirt, dust etc on any hard surface
- Washable up to 95°C.
- 400 x 400mm

F01262	pk 10	£7.67
--------	-------	-------



A Hill Brush 12" with Handle

- 12 Inch/30cm stiff broom with threaded handle complete
- Ideal for basic outside maintenance

F11-B12S	Soft Brush	each	£7.22
F11-B12H	Stiff Brush	each	£7.22



A

B Straight Sweeper Complete

- Our Dust Beater range of mop sweepers / floor dusters are lightweight, efficient and easy to use
- Complete with handle, frame and sleeve
- Blue

F15-516	16"/40cm	each	£16.43
F15-524	24"/60cm	each	£19.13
F15-532	32"/80cm	each	£21.41

Replacement heads for Straight Sweepers

F15-517B	16"/40cm Blue -	each	£4.35
F15-525B	24"/60cm Blue	each	£6.19
F15-533B	32"/80cm Blue	each	£7.76



B

C 40" V Sweeper Complete

- Lightweight, efficient and easy to use
- Dust control V sweeper with 'break frame' colour coded acrylic sweeper heads and aluminium handle with universal socket

F15-540	each	£64.37
---------	------	--------

Replacement Sleeves Blue

- Pack of 2 replacement sleeves for 40" V-Sweeper

F15-541	pk 2	£25.14
---------	------	--------



C

D Polyester Flick Duster with Extending Handle

- Polyester flick duster with plastic handle which extends to 118cm

F15-813	each	£1.57
---------	------	-------



D

E Yellow Duster

- Professional quality standard duster
- (20"x14")

F12-600	pk 10	£2.67
---------	-------	-------



E



CALL US ON 01527 878348



VISIT WWW.FORWARDPRODUCTS.CO.UK



A



B



C



D



E



F



G



H



A Standard Refuse Sacks

- Best value black sacks
- 80 litre capacity
- Size: 450mm (gusset width) x 725mm (open width) x 975mm (length)

80001		pk 200	£15.49
-------	--	--------	--------

B Heavy Duty Refuse Sacks

- Choose from heavy duty or extra heavy duty!
- 90 litre capacity
- Size: 460mm (gusset width) x 740mm (open width) x 965mm (length)

73376	Heavy Duty	bx 200	£19.31
97317	Extra Heavy Duty	bx 200	£20.11

C Black Sacks

- Designed for general household and industrial waste
- Made from 100% recycled polythene
- 18 x 29 x 39

F18-HP18	Medium Duty	pk 200	£14.57
F18-MD18	Heavy Duty	pk 200	£17.05

D Clear Refuse Sack Medium Duty Rolls

- Clear sacks perfect for recycling
- Can also be used for handling linen or other items where there is advantage to being able to see items inside the sack
- A decent gauge suitable for most applications and bins
- 18/29 x 39"

F18-CL18	12kg	box of 8 x 25	£16.62
----------	------	---------------	--------

E Square Bin Liners Medium Duty

- Medium duty square bin liners
- 375/600 x 600mm

F18-BL25		10 x 100	£18.02
----------	--	----------	--------

F Bin Liners

- Medium Duty

BL15L	For 15L Pedal Bins	pk 1000	£15.16
BL50L	For 50L Swing bins	pk 1000	£24.30

G Swing Bin Liners

- 56 gauge bin liners
- 20 bin liners per roll
- 30 litre capacity

53004		pk 4	£10.47
-------	--	------	--------

H Pedal Bin Liners

- 52 gauge pedal bin liners
- 30 bin liners per roll
- 15 litre capacity

41004		pk 4	£9.27
-------	--	------	-------



A Swing Top Bin 50 Litre

- Ideal for virtually any internal space
- One-piece moulded smooth sided polypropylene, easy to clean and hygienic
- Swing open lid that keeps waste out of sight
- Lift off lid for easy emptying
- Available in different colours depending on type of waste

STBWH	White	each	£19.99
STBBK	Black	each	£19.99
STBBL	Blue	each	£19.99
STBGT	Granite	each	£19.99
STBYW	Yellow	each	£19.99



A

B Black Plastic Dustbin with Lid

- Standard black dustbin with lid and handles which fold and lock the lid onto the bin
- 85 Litres

F14-135	each	£18.49
---------	------	--------

B



C Wastebasket Rect Blue

- An easy and effective way to recycle
- Tough plastic bin that will last years
- 26.6 litres

F14-2956	each	£10.02
----------	------	--------



C

D Litter Picker

- Made from aluminium
- Ideal for picking up litter, cans, bottles, etc.
- 80cm

F18-446	each	£15.22
---------	------	--------



D

E Long Handled Dustpan and Brush Set - Black

- Superb value dust pan and brush combos
- The swing-up pan neatly carries litter
- Dustpan features lip to ensure flush fit to the floor and an integral brush holder clip
- Both are easy to hang for tidy storage
- Soft bristle brush is lightweight and easy to use
- Contains 1 x Dustpan, 1 x Handle, 1 x Brush

F11-LHDP	set	£11.90
----------	-----	--------



E

F Dustpan and Brush Set

- Our professional dustpan & brush set is made from durable plastic and is also rubber lipped
- Ideal for the professional cleaner

Soft Bristles

F11-065B	Blue	each	£2.19
F11-065G	Green	each	£2.19
F11-065R	Red	each	£2.19
F11-065Y	Yellow	each	£2.19

Stiff Bristles

F11-064B	Blue	each	£2.19
F11-064G	Green	each	£2.19
F11-064R	Red	each	£2.19
F11-064Y	Yellow	each	£2.19



F



CALL US ON 01527 878348



VISIT WWW.FORWARDPRODUCTS.CO.UK



A

A Multi Kentucky Mop Head

- Combination multi-yarn for heavier duty applications

F15-212	12oz	each	£1.41
F15-216	16oz	each	£1.73
F15-224	24oz	each	£4.67



B

B Exel PY Yarn 200gm Socket Mop Head

- Thick absorbant yarn for everyday use

F15-112B	Blue	each	£1.03
F15-112G	Green	each	£1.03
F15-112R	Red	each	£1.03
F15-112Y	Yellow	each	£1.03



C

C Big White Socket Mop

- Highly absorbant, cost effective mop head
- Absorbs up to 3 times its weight in water
- Colour coded and easy to wring out

F15-PSB	Blue	each	£0.89
F15-PSG	Green	each	£0.89
F15-PSR	Red	each	£0.89
F15-PSY	Yellow	each	£0.89
F15-PSW	White	pk 10	£12.38



D

D Revolution Mop Head Small 250g

- A Hygiemix socket mop with an Exel® Socket are produced from a unique 50/50 blend of bleached cotton and synthetic yarn for absorbency and strength
- Improved performance circular profile looped white yarn with colour-coded band mop socket
- These mops are launderable up to 60°C
- Depending on the chemicals used and the surfaces these mops are used to clean, the mop heads should wash around 80 times

F15-RM25B	Blue	each	£3.13
F15-RM25G	Green	each	£3.13
F15-RM25R	Red	each	£3.13
F15-RM25Y	Yellow	each	£3.13

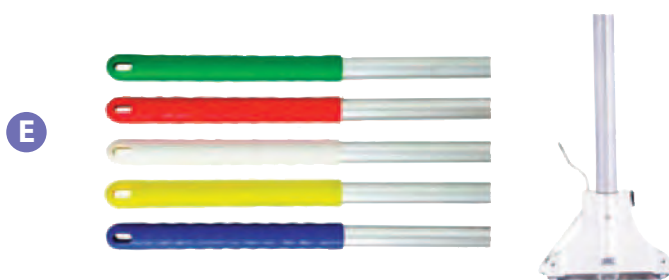

E

E Aluminium Kentucky Mop Handle

- Coloured aluminium handle for kentucky mop heads

F15-055B	Blue	each	£6.11
F15-055G	Green	each	£6.11
F15-055R	Red	each	£6.11
F15-055Y	Yellow	each	£6.11



F

F Excel Handle

- 137cm alloy handle with easy push fitting

F15-100B	Blue	each	£6.27
F15-100G	Green	each	£6.27
F15-100R	Red	each	£6.27
F15-100Y	Yellow	each	£6.27



A Mop Bucket with Wringer

- Deluxe mop bucket with fixed handle, large cone wringer, pouring lip and dilution markings

F14-300B	Blue	each	£4.73
F14-300G	Green	each	£4.73
F14-300R	Red	each	£4.73
F14-300Y	Yellow	each	£4.73



A

B Kentucky Mop Bucket and Wringer

- Quality kentucky mop bucket and wringer on 3" heavy duty plastic castors

F15-1005B	Blue	each	£50.57
F15-1005G	Green	each	£50.57
F15-1005R	Red	each	£50.57
F15-1005Y	Yellow	each	£50.57



B

C 9 Litre Bucket

- 9 Litre bucket made with high-density polypropylene with white handle
- Graduated in 1 Litre steps

F14-414B	Blue	each	£2.33
F14-414G	Green	each	£2.33
F14-414R	Red	each	£2.33
F14-414Y	Yellow	each	£2.33



C

D Yellow Folding Sign - 'Wet Floor/Cleaning in Progress'

- All plastic heavy-duty sign, folds flat for easy carrying and transportation
- Vivid bright yellow with eye-catching red and black signage printed both sides "Wet Floor" on one side, "Cleaning in Progress" on the reverse

F15-601	each	£5.08
---------	------	-------



D

A



A Finish Powerball Dishwash Tablets

- #1 Recommended by renowned dishwasher manufacturers
- X2 Power actions - powerful clean, tea stain removal
- Finish classic with pre-soaking action
- The powerball soaks and softens tough food stains and powerful detergents lift off and wash away all traces of food

F04-454 pk 110 £12.41

B



B Fairy Original Dishwasher Tablets

- The concentrated power of Fairy in a tablet
- Fast dissolving, with gel that cuts through grime

21554 pk 100 £36.24

C



C Windmill Non Bio Washing Powder

- Controlled foam, low lather washing powder for front and top loading washing machines, very effective on stains
- Suitable for hand washing
- 10kg

F08-105	Non Bio	10kg	£15.84
F08-100	Bio	10kg	£15.84

D



D Windmill Superior Washing Up Liquid

- Super concentrated unperfumed multi purpose dishwashing detergent
- Long lasting streak-free formulation Biodegradable, phosphate and formaldehyde free

F04-181 5 Litre £6.75



A Washing Up Liquids

- Choose from the original Fairy Liquid or our own economy version

F00743	Fairy 615ml	each	£2.95
58394	Economy 1 Litre	each	£2.32
WL1QD5	Economy 5 litre	each	£6.20



A

B Evans Lemon Washing Up Liquid

- Good quality washing up liquid in 500ml bottle
- For manual cleaning of crockery, glassware and kitchen utensils, tough on grease, gentle on skin
- Easy to handle, ergonomic bottle
- Fresh lemon fragrance

F04-152	500ml	£0.95
---------	-------	-------



B

C Green Scourers

- Standard green scourer for general purposes
- Size: 9 x 6"

F12-090	pk 10	£1.43
---------	-------	-------



C

D Green Sponge Scourer

- Strong and long-lasting extra thick sponge scourers

F12-065	pk 10	£2.38
---------	-------	-------



D

E Miraclean Magic Sponges

- The magic foam sponge removes scuff marks from floors, plastic car bumpers, crayon marks from walls, limescale from taps, burnt on food from pots and pans and many other stains

F12-MIR10	pk 12	£4.30
-----------	-------	-------



E

F Hill Brush Dish Brushes

- Standard economy dishwash

F11-DW582	each	£0.79
-----------	------	-------



F



CALL US ON 01527 878348



VISIT WWW.FORWARDPRODUCTS.CO.UK

A



A Charm Airfreshener

- Charm room fragrance contains a blend of natural oils that help effectively neutralise unpleasant odours, leaving a fresh distinctive fragrance to enhance any room
- 3 in 1 Action Fresh fragrance, eliminates odours and acts in seconds

F06-630A	Tropical	300ml	£0.78
F06-630	Aroma Rose	300ml	£0.78

B



B Toilet Cleaners

- High specification products providing affordability and quality
- All supplied in 750ml bottles

43099	Clean & Fresh Thick Bleach	each	£2.19
-------	----------------------------	------	-------

C



C Toilet Brush Set

- Hygienic holder with a durable brush

91659		each	£2.39
-------	--	------	-------

D



D Hill Brush Toilet Brush Set in Holder

- 356mm domed head, polypropylene, with bowl type holder

F11-N6Y		set	£2.24
---------	--	-----	-------

E



E Windmill Warrior - Toilet Cleaner And Descaler

- Viscous formula clings longer for more thorough action
- A concentrated lavatory cleaner which removes limescale and organic deposits
- Cleans and descales washroom areas
- For use on all ceramic and stainless steel urinals and toilets

F05-800	1 Litre	£1.41
F05-801	5 Litre	£6.32



A Windmill Gladiator - Non pDCB Urinal Blocks

- Water Soluble cleaning and deodorising blocks for use in all types of troughs and urinals
- Cleans pipework and trap
- Lasting freshness
- Water soluble
- Economical and convenient to use
- Lasting freshness

F05-502Y	3Kg	each	£14.17
----------	-----	------	--------



A

B Pine Disinfectant

- General disinfecting of floors, walls & drains
- Effective against e.coli and staph aureus
- 5 litre container

41736	Pine Disinfectant	each	£4.41
-------	-------------------	------	-------



B

C Detergent

- Concentrated detergent for dishwashing
- Advanced blend for powerful but mild degreasing action
- Leaves crockery, cutlery and glassware sparkling clean
- Also ideal for general cleaning
- Dilution: 1:300
- 5 litre containers

41737	Detergent	pk 2	£7.47
-------	-----------	------	-------



C

D Bleach

- Clings to surfaces for longer contact time
- Effective in keeping drains and lavatories clean and sweet smelling
- 5 litre containers

41735	Standard Bleach	pk 2	£4.15
-------	-----------------	------	-------

41734	Thick Bleach	pk 2	£6.02
-------	--------------	------	-------



D



A



A Interfold Hand Towel Dispenser

- Key opening, robust vandal-resistant ABS plastic dispenser
- Capacity: approx 400 C-Fold or 600 Z-fold/interfold

HTD528W	each	£19.62
---------	------	--------

B



B C Fold Hand Towels

- Traditional C fold hand towels
- Available in single ply (blue) or two ply (white)

HTCFB	Blue Towels	pk 2640	£13.19
HTCFW	White Towels	pk 2355	£15.17

C

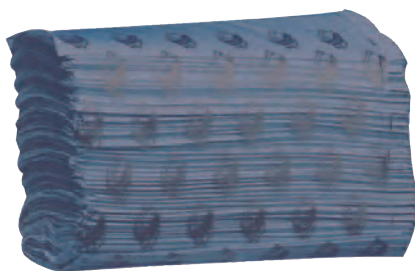

C Single Fold Interleaved Hand Towels

- Reduce hand towel wastage by over 50% with single fold hand towels
- Special design dispenses 1 fully open towel each time drastically cutting wastage
- Single ply

HTVFB	Blue Towels	pk 3600	£15.63
-------	-------------	---------	--------

D

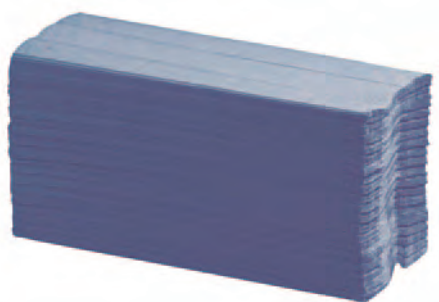

D Z Fold Hand Towels

- Economical Z fold hand towels
- Single ply blue tissue

HTZFB	Blue Towels	pk 3000	£16.29
-------	-------------	---------	--------



A Luxury Interfold Hand Towels

- 2 Ply White - Case of 3200
- The absorbent tissue plies have been glued together and micro-embossed to produce a luxurious towel that quickly dries wet hands
- Softer towels are recommended for staff who have to wash their hands frequently during the day
- Like all interfold towels, it dispenses easily, presenting a new flap to the next user, and offers excellent value for money
- Ideal for offices, surgeries, hotels and restaurants



HTVFW	Case 3200	£25.17
-------	-----------	--------

B Wall Mounted Roll Dispenser

- Quality tough dispensers for use with paper rolls
- Powder coated dark grey steel construction
- Shelf above for storage

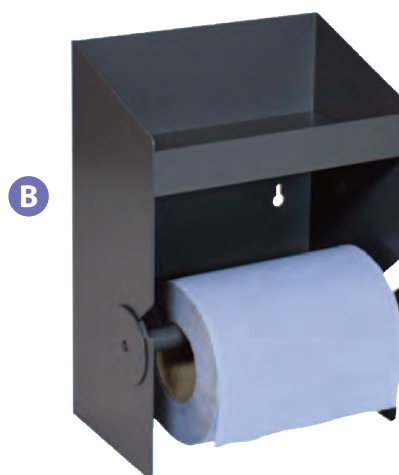

F28-210	each	£56.75
---------	------	--------

C Centre Feed Hand Towel Dispenser

- White plastic lockable dispenser
- Maximum roll size - 230mm high and 230mm diameter



HTD8311W	each	£26.35
----------	------	--------

D Centre Feed Rolls

- 150m x 195mm centre feed wipes
- Two ply tissue
- Ideal for classroom or site team



CFRBL	Blue	pk 6	£13.15
-------	------	------	--------





**LOWEST
PRICE**

A**A 2 Ply Standard Toilet Rolls**

- Perforated two-ply toilet rolls
- Soft tissue for ultimate comfort
- Twin wrapped for convenience

43092	200 Sheet	pk 36	£8.31
TRST320	320 Sheet	pk 36	£8.87

B**B Mini Jumbo Toilet Rolls**

- Two ply mini jumbo toilet rolls
- 80mm core (3")
- 90mm x 200m long
- Soft tissue for ultimate comfort

TRMJ80	Refills	pk 12	£15.69
--------	---------	-------	--------

C**C Jumbo Toilet Rolls**

- Two ply jumbo toilet roll
- 80mm core
- 90mm x 400m long
- Soft tissue for ultimate comfort

TRJ80	Refills	pk 6	£15.69
-------	---------	------	--------

D**D Mini Jumbo Toilet Rolls 2 Ply**

- 100% Recycled paper
- One of the most economical systems for use in heavy use areas like tourism

White 150m Standard Core

F01-625	pk 12	£11.95
---------	-------	--------

White 200m Standard Core

F01-622	pk 12	£15.70
---------	-------	--------



A Bulk Pack Toilet Tissue

- Two ply bulk pack toilet tissue refills
- 250 sheets per sleeve, 36 sleeves per pack
- Soft tissue for ultimate comfort

TRBULK	Refill	pk 36	£15.69
--------	--------	-------	--------



B Facial Tissues

- Handy to keep in the office or classroom
- Soft and very absorbent

F00001	Mansize Box 100	each	£1.13
F00002	Standard Box 100	each	£0.93



C Facial Tissues 2 Ply White

- 2 Ply soft facial tissues
- 36 Boxes of 100 per case

F01-944		36 x 100	£22.46
---------	--	----------	--------



D Kitchen Roll

- Ideal for everyday use
- Kitchen rolls are 2 ply with 60 sheets per roll

17340	Kitchen Roll	pk 24	£9.95
-------	--------------	-------	-------



E Rhino 3 Ply Kitchen Roll

- Offers super strength and absorbency due to its unique Liqui-Sorb technology
- Extra large sheets
- 3 ply pack 6 x 100 sheets

KR3PLY	Kitchen Roll	pk 6	£7.57
--------	--------------	------	-------



F Paper Napkins

- Ideal for everyday use
- 2 ply pack of 100

32101	Napkins 2 Ply	pk 100	£3.59
-------	---------------	--------	-------



CALL US ON 01527 878348



VISIT WWW.FORWARDPRODUCTS.CO.UK



A

All Items
on this page
are Non-
Returnable

A Nescafe Original Coffee

- Medium-dark roast for fuller flavour and refreshing taste

F00036AV	750g	each	£32.15
85680	500g	each	£29.25



B

B PG Tips Pyramid Tea Bags

- Pyramid bag technology to ensure a perfect cup everytime

F05264		pk 1150	£32.20
--------	--	---------	--------



C

C Tetley One-Cup Tea Bags

- High quality all round tea
- Perfect for one cup serving

F03901		pk 1100	£32.60
--------	--	---------	--------



D

D Aero Hot Chocolate

- Deliciously smooth
- Only 99 calories per serving
- 1Kg tub

48043		each	£15.83
-------	--	------	--------



E

E Cadbury's Hot Chocolate

- The original chocolate drink
- Simply add hot water
- 2Kg tub

F06232		each	£25.06
--------	--	------	--------



F

F White Granulated Sugar

- Pure white crystalline sugar
- Contains no additives or preservatives
- Ideal for hot drinks

TLGS1KG		1kg	£1.72
---------	--	-----	-------



G

FOR KETTLES &
URNS

SEE PAGE 299

G White Sugar Sachets

- Ideal for sweetening tea and coffee
- Handy sachet measures

F00377		pk 1000	£11.30
--------	--	---------	--------



A Milk and Creamer Pots

- UHT for longer life
- 14ml portions

99486	Half Fat	pk 120	£6.33
-------	----------	--------	-------



A

B Insulated Drinking Cups

- Insulated polystyrene disposable cups, 200ml
- Suitable for hot drinks

F08060	Cups 200ml	pk 25	£1.39
F00807	Lids for 7oz Cups	pk 100	£3.63



B

C Clear Drinking Cups

- Ideal for cold drinks
- Not suitable for vending machines

81140		pk 1000	£22.29
-------	--	---------	--------



C

D Blue Drinking Cups

- Ideal for cold drinks
- Not suitable for vending machines

92810		pk 1000	£20.33
-------	--	---------	--------



D

E Plastic Vending Cups

- Suitable for vending machines
- Plastic 7oz

43096		pk 2000	£29.92
-------	--	---------	--------



E

F Disposable Paper Plates

- Great for parties, picnics and buffets
- Fully recyclable

75061	180mm / 7"	pk 100	£3.50
75081	230mm / 9"	pk 100	£4.92



F

G Wooden Coffee Stirrers

- Made from sustainable birch wood
- Dispenser box
- Ideal for hot drinks

F00011RY	Stirrers	pk 1000	£7.55
----------	----------	---------	-------



G

A



A Aluminium Foil

- Durable foil in dispenser box
- 450mm x 75m

23056	Foil	each	£14.53
-------	------	------	--------

B



B Cling Film

- Box of cling film 300mm x 300m

32080	Cling Film	each	£7.18
-------	------------	------	-------

C



C Tea Towels

- Absorbent checked tea towels in assorted colours

TT02228		pk 10	£8.42
---------	--	-------	-------

D



D Cordless Kettle

- Great value kettle
- Convenient cordless design
- 1.5 litre capacity

12002	Kettle	each	£11.94
-------	--------	------	--------

E



E 4 Slice Toaster

- Browning control
- Removable crumb tray
- Defrost, reheat & cancel functions
- Stop function

12010	Toaster	each	£21.75
-------	---------	------	--------

F



F Stainless Steel Urns

- Concealed stainless steel element for easy cleaning
- Water level gauge with built-in indicator
- Keep warm function with non-drip two way tap
- Boil dry cut-out safety feature
- Secure locking lid
- A choice of two sizes

52927	8 Litre	each	£76.85
52928	17 Litre	each	£99.64



A Heavy Duty Platform Truck

- A heavy duty metal truck, ideal for all-round use
- Easily manoeuvrable on 2 fixed and 2 swivel 150mm rubber castors
- Platform size: 1000 x 700mm
- Dimensions: W700 x D1000 x H880mm
- Load capacity 300Kg

27018	each	£210.20
-------	------	---------



B Platform Trolleys

- Small plastic trolley - ideal for use in and around the school
- Features include: injection moulded platform, folding handle and rubber tyred castors
- Handle height 820mm
- Platform W385 x D600 x H150mm
- Maximum load 120kg

27035	each	£70.85
-------	------	--------



C Service Trolley

- Quality service trolley with aluminium uprights
- Easy to clean for hygienic catering use
- Shelves manufactured from hard wearing plastic with 25mm rim on three sides and a 5mm rim to one side
- Trolley size, W410 x D800 x H790 mm
- Optional pack of two plastic buckets
- Bucket sizes: W232 x D332 x H172mm and W236 x D336 x H562 mm

27041	Trolley	each	£125.86
27042	Buckets	pk 2	£43.51



A



A Folding 2 Tread Step Stool With Soft Grip Handle

- Simple automatic folding 2 tread stepstool
- Folds away for easy storage
- Non slip rubber treads
- Size: W450 x D520 x H820mm
- Size when folded: H450 x W90 x D1065mm
- Image shown for illustrative purposes only

23123	Step Stool	each	£59.99
-------	------------	------	--------

B



B Safety Step Ladders

- Professional aluminium safety ladders
- Extra large storage platform
- Strong, deep treads for comfort and security
- Twin safety handrails

10503A	3 Tread (not shown)	each	£93.24
10505	5 Tread	each	£129.96
10507	7 Tread	each	£160.50

C



C Metal Kick Stools

- Metal step stool with 3 spring loaded castors
- Base ring holds kickstool rigid to the floor immediately weight is applied
- Heavy duty construction for demanding environments
- 425mm high, 290mm in diameter
- Available in several attractive colours

212101	Black	each	£50.09
212102	Red	each	£47.67
212112	Blue	each	£47.67
212137	Grey	each	£47.67
212138	Green	each	£47.67



Don't Get Caught Out This Winter!

Be prepared for slippery paths and playgrounds



Pure White ROCK SALT

specialy designed for
reduced floor staining

Mini Batch

- 14 x 25kg bags

ICE14	14 x 25kg bags	£133.47
-------	----------------	---------

Half Pallet

- 21 x 25kg bags

ICE21	21 x 25kg bags	£165.52
-------	----------------	---------

Full Pallet

- 42 x 25kg bags
- **FREE** Spreader SB41

ICE42	42 x 25kg bags	£243.76
-------	----------------	---------

Winter Wizard

- Winter Wizard 2kg shaker tub de-icing salt
- Melts snow and ice fast!
- Supplied in boxes of 6

WW2KG	pk 6	£29.50
-------	------	--------



NEW!





Forward Furniture are experienced in the supply and installation of furniture for schools, universities and offices. From classrooms and breakout areas through to boardrooms and executive suites, our expertise in interior solutions ensures you get the furniture you want, in the way you want, at the price you need!

1. Assisting you with choosing the right furniture; our inhouse experts are on hand to discuss your requirements to ensure that the correct furniture is specified
2. Site visits or video calls to go through your needs in more detail if relevant
3. CAD space planning assistance so you can visualise your space
4. Providing samples of fabrics, wood finishes and even pieces of furniture where necessary
5. Installation and project management; depending on the size and complexity of your requirements, we take the hassle out of project delivery and keep you updated at every step of the process



If you have a larger project entailing fitted furniture, our projects division John Knight Interiors are here to help.

Please see pages 585-586 for further John Knight Interiors details



Contents



Classroom Chairs

307-329



Classroom Tables

330-353



Classroom Storage

354-384



Early Years Furniture

385-394



Healthcare

395-402



Office Accessories

403-424



Office Seating

425-450



Soft Seating

451-470



Office Furniture

471-522



Express Office Furniture

523-530



Steel Storage

531-544



Dining Furniture

545-558



Fabrics

559-570



Index

571-583



Recent Case Studies



Cloakroom Furniture



Dining Hall Tables & Chairs



Study Area Furniture



Office Furniture & Storage



Breakout Furniture



Classroom Furniture

Important Ordering Information...

To ensure your furniture ordering experience is as seamless as possible, please carefully read through the following important checklist...

01 Order early

Place your order as early as you can to avoid extended lead times during the summer months.

02 Check your order

Ensure you are ordering the correct dimensions and colours. Products are made to order so any returns or amendments after an order is confirmed may incur an extra charge. Sizes should also be checked to ensure that the correct size is ordered to suit the correct age group.

03 Contact details

Please supply contact name(s) and mobile phone numbers on all orders. This helps us book deliveries or to call the correct contact during school holidays.

04 Opening times

Please advise opening times if you are expecting a delivery within school holidays. These details will be used to install or deliver the goods on a convenient date.

05 Prepare for the delivery

Remember to keep hold of your old furniture until your new goods arrive, just in case any delays or issues occur. Ensure that there are staff available to receive the delivery as some courier policies are to deliver to the nearest undercover area so some items may need to be moved to the relevant part of the school.

06 Delivery

Some deliveries will be made by pallet via third party couriers within the pallet network and are curbside delivered. Please inform us before placing your order if this is an issue and we will discuss alternative transport options and any relevant costs. Please note, it is the customer's responsibility to remove or dispose of any packaging, including the wooden pallet itself.

07 Returns

Please note furniture is made to order and is therefore generally non-returnable if it has been supplied as per your order. Some suppliers may agree to collect and exchange an item but will usually charge a restocking fee. If it is necessary to return any furniture items then please contact our customer services team on 01527 878348 or email sales@forwardproducts.co.uk.

Notes to remember when ordering

- All classroom and office furniture is made to order so it is important to ensure that the correct size and type of furniture is ordered.
- Delivery times fluctuate throughout the year with lead times being extended during peak months (June-September).



Educational Furniture Height Guide

To help you purchase educational furniture in the correct heights for children, the following guide outlines recommend table and chair heights that comply with the British and European Standards (1729). As pupil heights can vary from cohort to cohort we recommend you measure their stature and popliteal heights (see below for an explanation on these terms) and then match these up to the below guide. If your priority is to match the heights of existing furniture, you will need to check these and specify them when ordering.

Standing & Working Heights

To help you purchase furniture that complies with the British and European Standards (1729), the following height guide indicates which fixed seat heights and table heights are suitable for the correct age and size. To ensure you purchase the most accurate height furniture correct in compliance with the standards, we recommend that you measure the stature and popliteal height. You can then match those measurements using the guide below.

For a visual guide to the different chair and table heights, please refer to the table below.

	SIZE MARK	AGE RANGE	POPLITEAL HEIGHT RANGE	STATURE RANGE	TABLE HEIGHT	CHAIR HEIGHT
1	NURSERY	3-4 years	250 - 280mm	930 - 1150mm	460mm	260mm
2	PRIMARY	4-6 years	280 - 315mm	1080 - 1210mm	530mm	310mm
3	PRIMARY	6-8 years	315 - 355mm	1190 - 1420mm	590mm	350mm
4	PRIMARY	8-11 years	355 - 405mm	1330 - 1590mm	640mm	380mm
5	SECONDARY	11-14 years	405 - 435mm	1460 - 1765mm	710mm	430mm
6	SECONDARY/ADULT	14 +	435 - 485mm	1590 - 1880mm	760mm	460mm

Standing & Working Heights

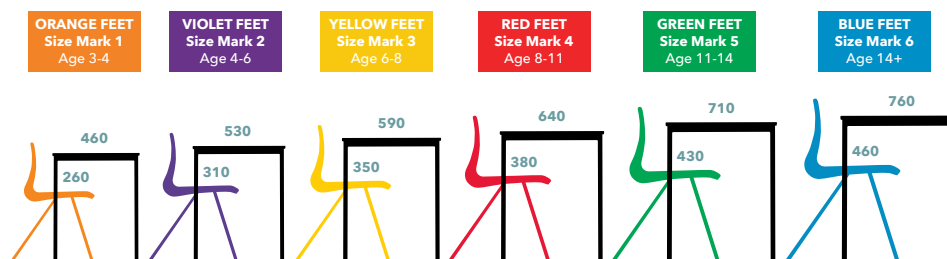

Popliteal Height

Popliteal height defines the correct seat height. The measurement is taken from the floor to the back of the knee when seated, with thighs horizontal and lower leg vertical with feet flat to the floor.

Stature

Stature is from floor to the top of the head.

Sitting Work Height

Sitting work height defines the correct table height. The measurement is determined by sitting elbow height, which is the distance from the floor to the underside of the elbow whilst sitting with the upper arm vertical and the lower arm horizontal.

Standing Work Height

Standing work height defines the correct standing table height. The measurement is determined by standing elbow height, which is the distance from the floor to the underside of the elbow of a standing person with the upper arm vertical and lower arm horizontal.

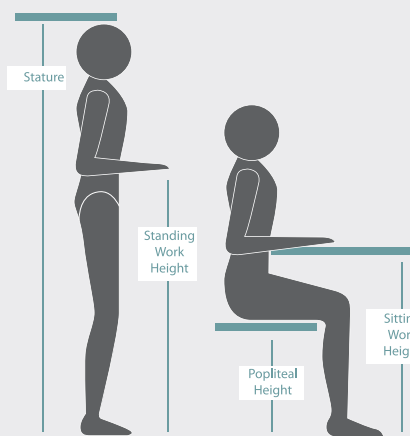

09

Classroom Chairs

Classroom Seating	309-319
Folding Chairs	320
IT Seating	321-322
Stools	323-327
High Chairs	327-328



Dumbell Wobble Stool

An active sit for engaged learning, Dumbell stools support student movement, which is essential for cognitive development. Featuring a rounded base for an active sit, the stools offer freedom to fidget, which can help keep bodies and minds engaged. With its small scale and light weight, it is easy for students and teachers alike to carry and reposition as needed. When flipped, the gently concaved top with waterfall edge nests with the convex base to stack up to 3-high. The colour options offer playful appeal, while all-poly construction and a nonslip base design ensure durability and stability for years to come.

- All seating surface pad, base and spacer rings are in Iron Grey/Blue Grey (as shown). The underside is a textured, non-slip thermoplastic rubber padding in black
- Stacks up to 3 high (upside down)
- Available in 5 standard colours & 4 heights from 300-450mm
- Convex base offers 12° of rebounding motion
- Base weighted with steel for added stability
- Waterfall seat edge
- Thermoplastic rubber base is non-slip and suitable for carpet and hard floors
- Slightly concave seat pad with textured surface for added comfort
- Compact, lightweight & easy to move with integrated handle under seat lip

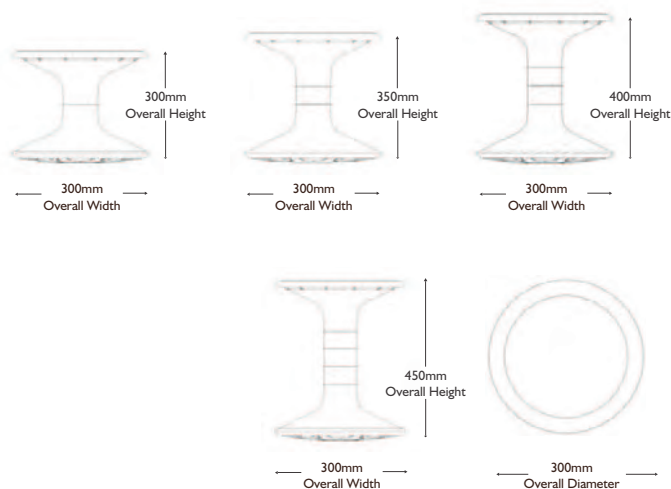

	Height	1-5	6-29	30+
C212631	300mm	£55.36	£52.05	£48.73
C212632	350mm	£57.87	£54.40	£50.94
C212633	400mm	£60.54	£56.91	£53.29
C212634	450mm	£64.13	£60.29	£56.45

* Please specify colour when ordering



Polypropylene Colours



Postura Plus Chairs

- Designed to promote posture and exceptional comfort
- Fully certified to EN1729 Parts 1 & 2 for dimensions, strength and stability
- 20 year guarantee
- Stackable up to 12 high (chair only)
- Please check colour availability when ordering as some colours are only available in larger sizes
- **Please see Important Furniture Ordering Information on page 306 before placing your furniture order**



Postura Plus Chair

		1-5	6-29	30+
C212811	H260mm	£24.32	£19.35	£18.57
C212812	H310mm	£25.49	£20.28	£19.47
C212813	H350mm	£26.04	£20.71	£19.88
C212814	H380mm	£26.99	£21.47	£20.61
C212815	H430mm	£29.57	£23.52	£22.58
C212816	H460mm	£31.20	£24.82	£23.83



Postura Plus High Chair

- Integral bag hook

		1-5	6-29	30+
C212821	H560mm	£66.54	£57.67	£55.45
C212822	H610mm	£67.14	£58.19	£55.95
C212823	H685mm	£71.54	£62.00	£59.61



Postura Plus Stool

- Integral bag hook

		1-5	6-29	30+
C212831	H560mm	£55.26	£47.90	£46.05
C212832	H610mm	£56.40	£48.88	£47.00
C212833	H685mm	£58.29	£50.52	£48.58



Postura Plus Task Chair

- Available with castors or glides, please specify when ordering

		1-5	6-29	30+
C212841	Chair w/Castors	£80.90	£72.95	£69.95
C212842	Chair w/Glides	£80.90	£72.95	£69.95

Seat Colours





5-7 day
delivery

20
YEAR
GUARANTEE



Stackable 15 high



Linking clip

Titan One Piece Chairs

- This innovative chair is the first one-piece polypropylene chair that has attained EN1729 certification
- The benefit of one-piece polypropylene chairs is well documented in terms of their longevity (20 year guarantee), comfort and safety in the classroom
- With no screws or rivets, no sharp edges and no metal work to rust, the Titan chair offers all the benefits of a one-piece chair with the added EN1729 certification
- Stackable 15 high and offering excellent value for money
- 20 year guarantee
- **Please see Important Furniture Ordering Information on page 306 before placing your furniture order**

Titan Chairs

		1-5	6-29	30+
C212691	H310mm	£21.55	£17.14	£16.39
C212692	H350mm	£22.42	£17.83	£17.06
C212693	H380mm	£22.64	£18.01	£17.22
C212694	H430mm	£25.55	£20.32	£19.63
C212695	H460mm	£25.95	£20.65	£19.95
C212696	Linking Attachment	£3.68	£2.93	£2.88

Please Specify:

Seat colour

Seat Colours



Sizes 310, 350 and 380 are not available in Burgundy, Grey, Charcoal or Black



5-7 day
delivery

Titan 4 Leg Chair

- Combining the comfort of the plastic seat with strong steel legs and protective feet
- Super strong tubular steel frame
- 10 year guarantee

Code	Seat Height	Overall Width	1-5	6-29	30+
C212721	350	440	£24.58	£20.68	£19.69
C212722	380	440	£24.78	£20.85	£19.84
C212723	430	500	£25.34	£21.32	£20.29
C212724	460	500	£25.99	£21.86	£20.80

Please see Important Furniture Ordering Information on page 306 before placing your furniture order

Titan Skid Chair

- Skid based chair for ease of movement, stacks up to 5 high
- Ultra strong oval tube steel frame
- 10 year guarantee

Code	Seat Height	Overall Width	1-5	6-29	30+
C212741	350	480	£27.19	£22.88	£21.77
C212742	380	480	£28.03	£23.58	£22.44
C212743	430	540	£28.58	£24.04	£22.88
C212744	460	540	£28.80	£24.23	£23.06

Please Specify:

Seat colour

Seat Colours



Red Blue Yellow Green Burgundy Grey Charcoal Black Lime Purple Orange Sky Blue

Sizes 350 and 380 are not available in Burgundy, Grey, Charcoal or Black





Sustainable materials - uses less materials than other chairs in its class

EN One Piece Chair

- Lightweight one piece polypropylene chair with unique back handhold
- Streamline modern design with exceptional ergonomics
- Efficient to store, up to 21 chairs stack within a 2 metre height
- 21 year guarantee
- Please specify seat colour required when ordering
- **Please see Important Furniture Ordering Information on page 306 before placing your furniture order**

		1-5	6-29	30+
C212753	H260mm	£22.30	£16.36	£15.49
C212754	H310mm	£23.15	£16.99	£16.08
C212755	H350mm	£24.22	£17.77	£16.83
C212756	H380mm	£25.51	£18.72	£17.72
C212751	H430mm	£30.23	£22.18	£20.99
C212752	H460mm	£30.86	£22.64	£21.44



Perfect for high volume applications

Please Specify:

Seat colour

Seat Colours

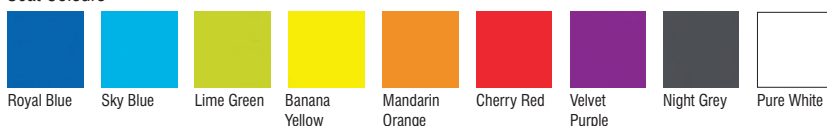

Stacks up to 21 high



EN Series Chair

- Popular and robust polypropylene chair with gas injected ribbing for ultimate shell strength
- Ergonomic shell support for the lower back, flexing naturally with the user's movement
- Angled rear legs to prevent user tilting
- Stacks 6 high
- Exceptional 15 year guarantee
- Stylish silver grey frame as standard. Chrome frame available on some sizes, please call for details



		1-5	6-29	30+
C212761	H260mm	£44.80	£33.84	£32.19
C212762	H310mm	£44.80	£33.84	£32.19
C212763	H350mm	£47.01	£35.50	£33.77
C212764	H380mm	£47.01	£35.50	£33.77
C212765	H430mm	£50.16	£37.88	£36.05
C212766	H460mm	£50.16	£37.88	£36.05

EN Series Skid Base Chair

- Stacks 5 high
- 460mm high only

		1-5	6-29	30+
C212771	H460mm	£60.99	£46.06	£43.82



EN Series Reverse Cantilever Chair

- H460mm
- Stacks 5 high

		1-5	6-29	30+
C212776	H460mm	£82.30	£62.68	£60.31



Please see Important Furniture Ordering Information on page 306 before placing your furniture order

Please call for prices on bulk quantities

Please Specify:

Seat colour

Seat Colours



*Chair heights 260, 310, 350 and 380 only available in these colours



Classic Chair

- Very popular polypropylene chair with distinctive hand hold for easy handling
- Wide range of seat colours
- 5 year guarantee
- Tested to EN1729 for strength and stability
- Please confirm seat colour when ordering
- Stack 15 high
- Black 19mm steel frame

		1-5	6-29	30+
C212571	H260mm	£27.98	£19.60	£19.20
C212572	H310mm	£27.98	£19.60	£19.20
C212573	H350mm	£27.98	£19.60	£19.20
C212574	H380mm	£28.80	£20.17	£19.76
C212575	H430mm	£29.07	£20.36	£19.95
C212576	H460mm	£29.34	£20.55	£20.14

Please call for prices on bulk quantities

Please see Important Furniture Ordering Information on page 306 before placing your furniture order

Please Specify:

1. Seat colour

Standard Seat Colours

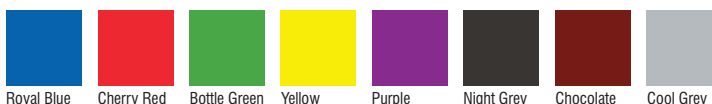



Storm Chair

- Classic look and feel
- Extremely strong and durable
- Unrivalled posture support across all ages
- Easy stacking up to 7 high
- Tested to EN 1729 Part 2
- 5 year guarantee

		1-5	6-29	30+
C212921	H260mm	£39.27	£29.49	£25.41
C212922	H310mm	£40.25	£30.22	£26.04
C212923	H350mm	£41.16	£30.91	£26.64
C212924	H380mm	£46.41	£34.85	£30.03
C212925	H430mm	£45.94	£35.88	£30.92
C212926	H460mm	£47.86	£37.38	£32.21



Storm Skid Base Chair

- Details as above but with a skid base

		1-5	6-29	30+
C212927	H430mm	£48.78	£44.23	£37.75
C212928	H460mm	£49.39	£44.44	£37.75



Please see Important Furniture Ordering Information on page 306 before placing your furniture order

Please Specify:

1. Seat colour
2. Frame colour

Seat Colours



Blue Charcoal Green Lilac Orange Purple Red Soft Blue Tangy Lime Yellow

Frame Colours

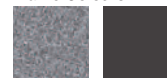

Speckled Grey Metallic Charcoal

Speckled Grey will be supplied if no colour is specified



Eco Chair

- Popular, high volume stacking chair
- Available in Black and Petrol Blue with a Black frame
- 430mm high
- 12 month guarantee
- Tested to EN 1729 Part 2

		1-5	6-29	30+
C212891	Petrol Blue	£21.55	£14.63	£13.35
C212892	Black	£23.71	£15.44	£14.03



Please see Important Furniture Ordering Information on page 306 before placing your furniture order



Affinity Chair

- Durable polypropylene chair with high quality steel frame
- Excellent stacking properties
- 6 year guarantee
- Tested to EN 1729 Part 2

		1-5	6-29	30+
C212911	H260mm	£20.36	£13.25	£13.42
C212912	H310mm	£22.19	£14.45	£13.76
C212913	H350mm	£22.95	£14.98	£14.21
C212914	H380mm	£24.30	£15.85	£15.11
C212915	H430mm	£24.82	£16.76	£15.84
C212916	H460mm	£26.21	£17.70	£16.74



Please Specify:

1. Seat colour
2. Frame colour

Affinity Chair Seat Colours



Frame Colours





Hype Chair

- Robust classroom chair giving great value for money
- Integral lumbar support and comfortable waterfall seat front
- Stackable up to 8 high
- 5 year guarantee
- Please confirm seat and frame colours when ordering



		1-5	6-29	30+
C212641	H260mm	£24.27	£18.34	£16.00
C212642	H310mm	£24.96	£18.86	£16.46
C212643	H350mm	£30.70	£23.20	£20.26
C212644	H380mm	£31.32	£23.67	£20.68
C212645	H430mm	£33.61	£25.40	£22.17
C212646	H460mm	£35.26	£26.64	£23.26



Hype Chair Trolley

- Easy to use trolley suitable for use with all Hype chairs
- Also suitable for use with most other 4 leg chairs

C212651	Chair Trolley	£82.62
---------	---------------	--------



Please see Important Furniture Ordering Information on page 306 before placing your furniture order

Please Specify:

1. Seat colour
2. Frame colour

Seat Colours



Blue

Charcoal

Green

Lilac

Orange

Purple

Red

Soft Blue

Tangy Lime

Yellow

Frame Colours -

Speckled Grey will be supplied if no colour is specified

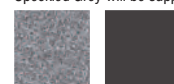

Speckled Grey

Metallic Charcoal



FULLY EN1729 COMPLIANT

15 YEAR GUARANTEE

Upholstered Version Available

Inspire Chair

- Ergonomically designed for correct posture
- Fully compliant to BSEN1729
- Smooth lines give a clean shape which is both comfortable and supportive
- Extra strong under carriage with no separate under-frame
- Outstanding 15 year guarantee
- Can be stacked up to 10 high
- Speckled grey frame colour as standard



Stacking



Linking

Code	Height	1-5	6-29	30+
C212851	260mm	£30.52	£22.87	£20.72
C212852	310mm	£32.10	£24.06	£21.80
C212853	350mm	£33.91	£25.41	£23.04
C212854	380mm	£34.87	£26.13	£23.68
C212855	430mm	£42.51	£31.85	£28.88
C212856	460mm	£44.14	£33.08	£29.98
C212857	Linking Device	£6.74	£6.42	£6.23
C212858	Upholstered Factory Fitted Seat Pad	£6.89	£5.23	£4.96

Please see Important Furniture Ordering Information on page 306 before placing your furniture order

Please Specify:

1. Seat colour
2. Fabric colour

Seat Colours



Fabric Options for Seat Pad

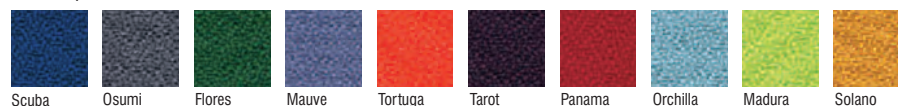

Folding Chairs

- Great range of folding chairs perfect for exams, events, school productions etc.
- Secure wrap-around back fixing to the frame
- Grey steel frame with double riveted cross braces for strength
- Protective feet buffers
- Comfortable fan back or straight back available
- Heavy duty trolley available for ease of transportation and storage
- **Please see Important Furniture Ordering Information on page 306 before placing your furniture order**



Fan Back Chair

- Integral linking feature
- Height 450mm

		1-5	6-29	30+
C212861	Blue Chair	£23.01	£16.88	£15.98
C212862	Burgundy Chair	£23.01	£16.88	£15.98
C212863	Grey Chair	£23.01	£16.88	£15.98



Straight Back Chair

- Height 450mm

		1-5	6-29	30+
C212871	Blue Chair	£21.44	£15.73	£14.90
C212872	Burgundy Chair	£21.44	£15.73	£14.90
C212873	Grey Chair	£21.44	£15.73	£14.90



Trolleys

- Heavy duty steel trolleys
- Two standard and two lockable castors
- Storage ratchet straps recommended for 40 chair flat bed trolley (not supplied)
- 40 chair trolley dimensions: W1100 x D490 x H90mm (not loaded)
- 60 chair trolley dimensions: W1770 x D780 x H1340mm (when loaded)

C212881	40 Chair Trolley	£158.87
C212882	60 Chair Trolley	£286.07



40 Chair Trolley



60 Chair Trolley

Please see Important Furniture Ordering Information on page 306 before placing your furniture order



EN Series Swivel Chair

- Elegant and comfortable IT chair
- Ergonomically shaped shell with gas injected ribbing for ultimate strength
- 15 year guarantee
- Available with castors or glides
- Height 390 - 520mm

		1-5	6-29	30+
T211121	With Castors	£83.23	£74.55	£72.38
T211122	With Glides	£83.23	£74.55	£72.38

Colour Options

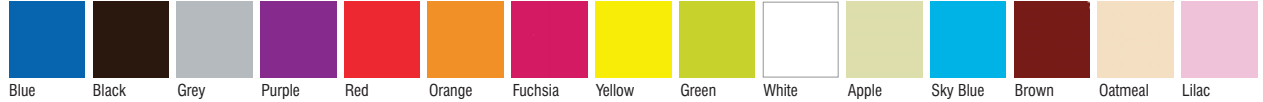

5 YEAR GUARANTEE

Now available in anti-microbial woven fabric, effective against Covid-19 see page 565

Tammerproof IT Chair

- Perfect for IT suites and classrooms
- Fixed back chairs with gas lift height adjustment
- 5 year guarantee
- Price based on Advantage fabric, please see pages 561-568 for further fabric options (prices POA)
- Heights: infant 320-410mm, junior 400-480mm & secondary 440-510mm
- Available with glides or castors

With Castors	Height mm	1-5	6-29	30+
T211135*	320 - 410	£92.78	£89.78	£82.61
T211136*	400 - 480	£92.78	£89.78	£82.61
T211137*	440 - 510	£92.78	£89.78	£82.61

With Glides	Height mm	1-5	6-29	30+
T211138*	320 - 410	£92.78	£89.78	£82.61
T211139*	400 - 480	£92.78	£89.78	£82.61
T211140*	440 - 510	£92.78	£89.78	£82.61

* Please specify fabric colour



Popular Fabric Colour Options



Premium Fabric – Aquarius (add 35% to prices)



See pages 561-567 for further fabric options



5 YEAR GUARANTEE

Classic IT Chair

- Strong poly shell on a tamper proof gas lift base
- The Classic IT chair is in use in hundreds of schools and is a proven reliable chair
- 5 year guarantee
- Height range 390-520mm
- Available with castors or glides

		1-5	6-29	30+
T211141	With Castors	£63.94	£57.91	£55.50
T211142	With Glides	£63.94	£57.91	£55.50



Colour Options

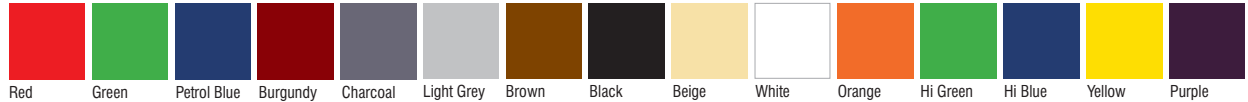

Hype Swivel Chair

- Robust IT chair giving great value for money
- Integral lumbar support and comfortable waterfall seat front
- 5 year guarantee
- Available in two heights with castors or glides

With Castors		1-5	6-29	30+
T211151	H355 - 420mm Black Base	£102.51	£70.39	£68.34
T211152	H420 - 480mm Black Base	£105.06	£72.14	£70.04
T211153	H355 - 420mm Chrome Base	£118.82	£87.42	£84.87
T211154	H420 - 480mm Chrome Base	£122.71	£90.28	£87.65
With Glides				
T211155	H355 - 420mm Black Base	£102.51	£70.39	£68.34
T211156	H420 - 480mm Black Base	£105.06	£72.14	£70.04
T211157	H355 - 420mm Chrome Base	£118.82	£87.42	£84.87
T211158	H420 - 480mm Chrome Base	£122.71	£90.28	£87.65



Colour Options - All Sizes

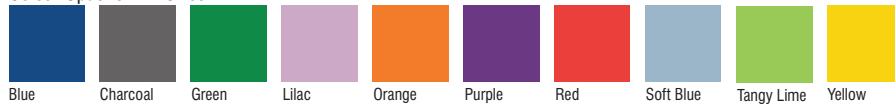

Please see Important Furniture Ordering Information on page 306 before placing your furniture order

Titan Swivel IT Chair

- Stylish chair with chrome base
- Complies with EN1729 regulations
- Junior sizes: H405 - 460mm
- Adult sizes: H465 - 555mm
- Castors or glides available

With Castors		1-5	6-29	30+
T211161	Junior	£59.16	£51.27	£49.30
T211162	Adult	£63.72	£55.22	£53.10
With Glides				
T211163	Junior	£59.16	£51.27	£49.30
T211164	Adult	£63.72	£55.22	£53.10



See pages 8 & 9 for matching 4 leg chairs



Colour Options - All Sizes





Steel feet are a valuable addition where harsh or abrasive floor surfaces wear down standard plastic feet.



Ergoform Stools

- The UK's best selling and most popular classroom stool
- These stools are specified for major projects country wide because of their unique seat shape and integral lumbar support
- The stools have a robust frame, unique lumbar support and a well positioned footrest
- The stools come in 10 shell colours with an option for steel feet and have a 5 year guarantee
- **Please see Important Furniture Ordering Information on page 306 before placing your furniture order**

		1-5	6-29	30+
C212931	H395mm	£44.07	£33.31	£31.30
C212932	H445mm	£44.07	£33.31	£31.30
C212933	H560mm	£44.07	£33.31	£31.30
C212934	H610mm	£44.07	£33.31	£31.30
C212935	H685mm	£44.07	£33.31	£31.30
C212936	Steel Feet Set 4	£5.30	£4.92	£4.70

Ergoform Skid Base Stool

- Reduce wear on floors
- Extremely strong and stable
- Same popular seat design

		1-5	6-29	30+
C212941	H610mm	£49.37	£37.31	£35.06
C212942	H685mm	£49.37	£37.31	£35.06

Please Specify:

1. Seat colour
2. Frame colour



Seat Colours



Frame Colours

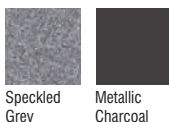

Speckled Grey will be supplied if no colour is specified

FULLY EN1729 COMPLIANT



Stool with Polished MDF Seat

- Based on the same design as the poly stacking stool, this stool has an MDF seat with a handhold
- Steel feet are essential where highly abrasive flooring is used
- Stackable up to 6 high
- Available with traditional polished MDF seat or hardwearing beech laminated seat
- Please see previous page for frame colour options

		1-5	6-29	30+
C212961	H470mm	£39.65	£29.96	£28.16
C212962	H520mm	£39.65	£29.96	£28.16
C212963	H570mm	£39.65	£29.96	£28.16
C212964	H620mm	£39.65	£29.96	£28.16
C212965	H670mm	£39.65	£29.96	£28.16
C212936	Steel Feet Set 4	£5.30	£4.92	£4.70



Stool with Beech Laminated Seat

- Please see previous page for frame colour options
- Same specification as above stools except with Beech laminated seat (not pictured)

		1-5	6-29	30+
C212971	H470mm	£39.65	£29.96	£24.73
C212972	H520mm	£39.65	£29.96	£24.73
C212973	H570mm	£39.65	£29.96	£24.73
C212974	H620mm	£39.65	£29.96	£24.73
C212975	H670mm	£39.65	£29.96	£24.73
C212936	Steel Feet Set 4	£5.30	£4.92	£4.70

Stained MDF tops available in 4 colours. Please call for details

Rectangular Stools

- This highly popular stool has a 22mm sturdy tubular frame with a poly seat
- Please see below for seat colour options
- Only available with black frames



Polyprop Stacking Stool

		1-5	6-29	30+
C212955	H610mm	£41.72	£29.80	£26.84
C212956	H660mm	£41.72	£29.80	£26.84

Please see Important Furniture Ordering Information on page 306 before placing your furniture order



Please Specify:

1. Seat colour

Standard Seat Colours



Slate

Green

Red

Blue



Beech Cantilever Stool

- Waterfall seat front
- Scuff resistant & anti-tilt feet buffers
- Complies to EN1729
- 50 x 30mm oval frame
- Stacking 6 high
- Fully welded grey frame
- Height 610mm
- 25 year frame guarantee

	1-5	6-29	30+
C212493	£65.44	£46.74	£43.79



Aero Stool

- New innovative design
- Aeriated, angled seat
- Heavy duty frame with stable design
- Long lasting Duragrip feet
- Choose from 7 bright, modern seat colours and 3 frame colours
- Complies with EN1729
- 10 year guarantee
- Please specify seat colour and frame colour at time of ordering

		1-5	6-29	30+
C212991	H430mm	£46.62	£34.63	£33.60
C212992	H525mm	£46.62	£34.63	£33.60
C212993	H610mm	£46.62	£34.63	£33.60
C212994	H685mm	£46.62	£34.63	£33.60
C212995	H760mm	£46.62	£34.63	£33.60

Please see Important Furniture Ordering Information on page 306 before placing your furniture order

Please Specify:

1. Seat colour
2. Frame colour

Seat Colours



Frame Colours



Zing Stool

- Sleek new moulded ply cantilever stool
- Perfect for laboratory, craft and food tech environments
- Stackable to 8 high
- Comfortable waterfall front edge and hand hold in back
- Funky coloured seats available
- Please specify seat and frame colours when ordering

Maple Seat		1-5	6-29	30+
C213121	H640mm	£105.90	£80.03	£77.53
C213122	H670mm	£106.87	£80.76	£78.24

Coloured Seat		60+
C213123	H640mm	POA
C213124	H670mm	POA



Please see Important Furniture Ordering Information on page 306 before placing your furniture order

Did you know?
Our John Knight Interiors division specialises in fitted furniture for science labs - call them on **01527 834798** to discuss your requirements



Please Specify:

1. Seat colour
2. Frame colour

Seat Colours



Maple Red Blue Green Orange Soft Blue Tangy Lime Yellow

Frame Colours



Speckled Grey Metallic Charcoal

Speckled Grey will be supplied if no colour is specified



CALL US ON 01527 878348



VISIT WWW.FORWARDPRODUCTS.CO.UK



Titan Stool

- Ergonomically designed stool with integral lumbar support
- Stylish and durable silver frame
- 10 year guarantee
- Stackable to 10 high
- Available in Charcoal, Black, Blue, Green, Grey and Red

		1-5	6-29	30+
C213131	H455mm	£50.60	£38.24	£35.93
C213132	H560mm	£50.60	£38.24	£35.93
C213133	H610mm	£50.79	£38.38	£36.06
C213134	H685mm	£50.79	£38.38	£36.06



Titan High Chair

- Derived from the popular one piece chair, the Titan High Chair has the same strength and comfort but with a stylish and durable high frame
- Skid base perfect for protection of hard floors in science labs and food tech rooms
- Non-stackable
- Available in all 12 colours as shown below

		1-5	6-29	30+
C213141	H455mm	£58.29	£44.05	£41.40
C213142	H560mm	£60.36	£45.62	£42.86
C213143	H610mm	£62.96	£47.58	£44.72
C213144	H685mm	£65.11	£49.21	£46.25



Please Specify:

Seat colour

Seat Colours Please note that stools are not available in Burgundy, Yellow, Lime, Orange, Sky and Purple

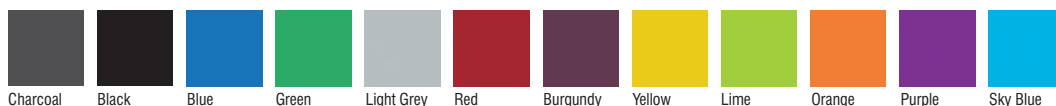

Hype High Chair

- Robust high chair giving great value for money
- Integral lumbar support and comfortable waterfall seat front
- Available in the 2 most popular heights

		1-5	6-29	30+
C213151	H610mm	£52.89	£36.32	£31.74
C213152	H685mm	£58.18	£39.95	£34.91



Storm High Chair

- Traditional looking high chair with large seat giving exceptional back support
- Very heavy duty frame with protective buffer feet
- Perfect for use in ICT, craft and science environments

		1-5	6-29	30+
C213161	H620mm	£62.36	£42.82	£41.57
C213162	H670mm	£69.93	£48.02	£44.29



Classic High Chair

- New stronger and sleeker design high chair
- Unique angled front foot rest
- 2 piece polypropylene construction provides excellent lumbar support
- Fully EN1729 compliant

		1-5	6-29	30+
C213171	H640mm	£62.36	£42.82	£39.49
C213172	H670mm	£69.93	£48.02	£41.96



Please Specify:

1. Seat colour
2. Frame colour

Frame Colours



Speckled Grey



Metallic Charcoal

Speckled Grey will be supplied if no colour is specified

Seat Colours



Blue



Charcoal



Green



Lilac



Orange



Purple



Red



Soft Blue



Tangy Lime



Yellow





Classroom Ultimate II Chair



Style Chair



Lumbar Chair



Classic High Chair



Classic Chair

Call for further details of our huge range of classroom seating

10

Classroom Tables

Classroom Tables	331-344
Craft Tables	345-346
Tilt Top Tables Desks	347
Height Adjustable Tables	348
Wooden Locker Desks	349
Teacher's Desks	350
Exam Desks	351
Carrel Study Units & Workstations	352



MDF Edge Classroom Tables

- These tables are proven in the education market and have passed FIRA tests for severe educational use
- Hardwearing laminated tops with bullnosed and lacquered MDF edges that cannot be picked
- **Please see Important Furniture Ordering Information on page 306 before placing your furniture order**



Fully welded frames - spiral stacking 5 high



Crushbent frames - slide stacking 8 high

Laminate Top Colours

Please Specify:

1. Top colour
2. Frame colour

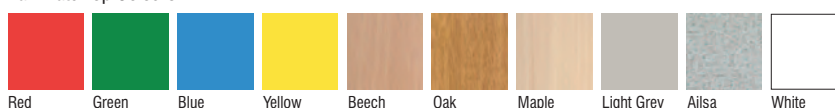

MDF Edge Detail

Frame Colours - Speckled Grey will be supplied if no colour is specified

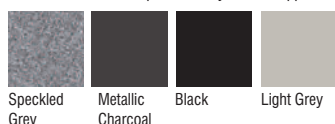

1200 x 600mm Rectangular



- Fully Welded Frame

		1-2	3-14	15+
C211111	H460mm	£81.46	£55.40	£53.21
C211112	H530mm	£81.46	£55.40	£53.21
C211113	H590mm	£81.46	£55.40	£53.21
C211114	H640mm	£81.46	£55.40	£53.21
C211115	H710mm	£81.46	£55.40	£53.21
C211116	H760mm	£81.46	£55.40	£53.21

- Crushbent Frame

		1-2	3-14	15+
C211121	H460mm	£81.46	£55.40	£53.21
C211122	H530mm	£81.46	£55.40	£53.21
C211123	H590mm	£81.46	£55.40	£53.21
C211124	H640mm	£81.46	£55.40	£53.21
C211125	H710mm	£81.46	£55.40	£53.21
C211126	H760mm	£81.46	£55.40	£53.21

1100 x 550mm Rectangular



- Fully Welded Frame

		1-2	3-14	15+
C211131	H460mm	£81.30	£55.28	£53.09
C211132	H530mm	£81.30	£55.28	£53.09
C211133	H590mm	£81.30	£55.28	£53.09
C211134	H640mm	£81.30	£55.28	£53.09
C211135	H710mm	£81.30	£55.28	£53.09
C211136	H760mm	£81.30	£55.28	£53.09

- Crushbent Frame

		1-2	3-14	15+
C211141	H460mm	£81.30	£55.28	£53.09
C211142	H530mm	£81.30	£55.28	£53.09
C211143	H590mm	£81.30	£55.28	£53.09
C211144	H640mm	£81.30	£55.28	£53.09
C211145	H710mm	£81.30	£55.28	£53.09
C211146	H760mm	£81.30	£55.28	£53.09

1100 x 550mm Trapezoidal



- Fully Welded Frame

		1-2	3-14	15+
C211151	H460mm	£81.53	£55.44	£53.25
C211152	H530mm	£81.53	£55.44	£53.25
C211153	H590mm	£81.53	£55.44	£53.25
C211154	H640mm	£81.53	£55.44	£53.25
C211155	H710mm	£81.53	£55.44	£53.25
C211156	H760mm	£81.53	£55.44	£53.25

- Crushbent Frame

		1-2	3-14	15+
C211161	H460mm	£81.53	£55.44	£53.25
C211162	H530mm	£81.53	£55.44	£53.25
C211163	H590mm	£81.53	£55.44	£53.25
C211164	H640mm	£81.53	£55.44	£53.25
C211165	H710mm	£81.53	£55.44	£53.25
C211166	H760mm	£81.53	£55.44	£53.25

Also available in 1200 x 600mm, please call for details



600 x 600mm Square

- Fully Welded Frame

		1-2	3-14	15+
C211171	H460mm	£67.37	£45.81	£44.00
C211172	H530mm	£67.37	£45.81	£44.00
C211173	H590mm	£67.37	£45.81	£44.00
C211174	H640mm	£67.37	£45.81	£44.00
C211175	H710mm	£67.37	£45.81	£44.00
C211176	H760mm	£67.37	£45.81	£44.00

- Crushbent Frame

		1-2	3-14	15+
C211181	H460mm	£67.37	£45.81	£44.00
C211182	H530mm	£67.37	£45.81	£44.00
C211183	H590mm	£67.37	£45.81	£44.00
C211184	H640mm	£67.37	£45.81	£44.00
C211185	H710mm	£67.37	£45.81	£44.00
C211186	H760mm	£67.37	£45.81	£44.00



1000mm Diameter Circular

- Circular tables not stackable
- Fully Welded Frame

		1-2	3-14	15+
C211191	H460mm	£127.35	£86.60	£82.77
C211192	H530mm	£127.35	£86.60	£82.77
C211193	H590mm	£127.35	£86.60	£82.77
C211194	H640mm	£127.35	£86.60	£82.77
C211195	H710mm	£127.35	£86.60	£82.77
C211196	H760mm	£127.35	£86.60	£82.77

- Crushbent Frame

		1-2	3-14	15+
C211211	H460mm	£127.35	£86.60	£82.77
C211212	H530mm	£127.35	£86.60	£82.77
C211213	H590mm	£127.35	£86.60	£82.77
C211214	H640mm	£127.35	£86.60	£82.77
C211215	H710mm	£127.35	£86.60	£82.77
C211216	H760mm	£127.35	£86.60	£82.77



Also available in 1100mm and 1200mm diameter, please call for details

1200 x 600mm Diameter Semi-Circular

- Fully Welded Frame

		1-2	3-14	15+
C211221	H460mm	£110.48	£73.65	£67.88
C211222	H530mm	£110.48	£73.65	£67.88
C211223	H590mm	£110.48	£73.65	£67.88
C211224	H640mm	£110.48	£73.65	£67.88
C211225	H710mm	£110.48	£73.65	£67.88
C211226	H760mm	£110.48	£73.65	£67.88

- Crushbent Frame

		1-2	3-14	15+
C211231	H460mm	£110.48	£73.65	£67.88
C211232	H530mm	£110.48	£73.65	£67.88
C211233	H590mm	£110.48	£73.65	£67.88
C211234	H640mm	£110.48	£73.65	£67.88
C211235	H710mm	£110.48	£73.65	£67.88
C211236	H760mm	£110.48	£73.65	£67.88



1100 x 550mm Diameter Semi-Circular

- Fully Welded Frame

		1-2	3-14	15+
C211241	H460mm	£110.48	£73.65	£67.88
C211242	H530mm	£110.48	£73.65	£67.88
C211243	H590mm	£110.48	£73.65	£67.88
C211244	H640mm	£110.48	£73.65	£67.88
C211245	H710mm	£110.48	£73.65	£67.88
C211246	H760mm	£110.48	£73.65	£67.88

- Crushbent Frame

		1-2	3-14	15+
C211251	H460mm	£110.48	£73.65	£67.88
C211252	H530mm	£110.48	£73.65	£67.88
C211253	H590mm	£110.48	£73.65	£67.88
C211254	H640mm	£110.48	£73.65	£67.88
C211255	H710mm	£110.48	£73.65	£67.88
C211256	H760mm	£110.48	£73.65	£67.88



The guides below show the measurements of each sizemark and age and stature ranges they are suitable for. This information is for guidance only. It is based on average pupil size across the EU.

Customers must ensure sizes are correct for their individual requirements

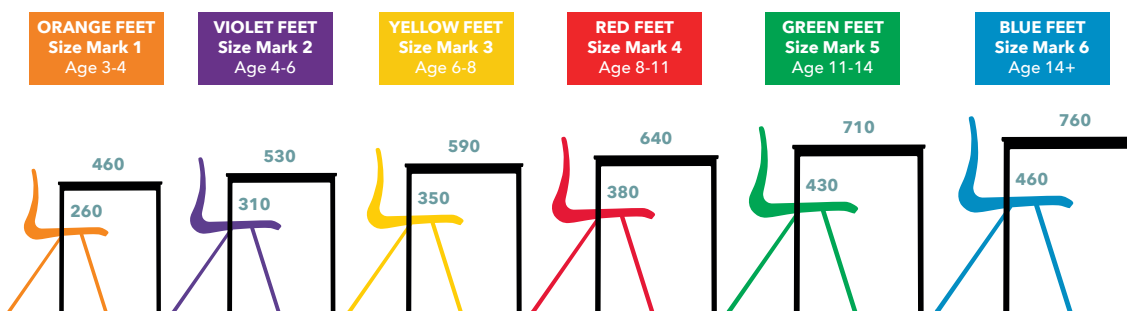

Table/chair sizes may vary slightly from the sizes shown. The standard allows heights to be within a 10mm tolerance.



CALL US ON 01527 878348



VISIT WWW.FORWARDPRODUCTS.CO.UK



PU Edge Classroom Tables

- Advanced impact resistant and waterproof PU textured edges
- FIRA rated for severe educational use
- Durable laminated tops with moulded PU edges
- **Please see Important Furniture Ordering Information on page 306 before placing your furniture order**



Fully welded frames - spiral stacking 5 high



Crushbent frames - slide stacking 8 high

Please Specify:

1. Top colour
2. Edge colour
3. Frame colour

Laminate Top Colours

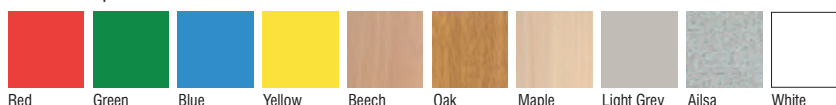

PU Edge Colours



Frame Colours - Speckled Grey will be supplied if no colour is specified

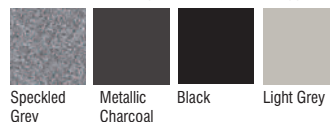

PU Edge Detail



1200 x 600mm Rectangular



- Fully Welded Frame

		1-2	3-14	15+
C211421	H460mm	£99.06	£67.36	£64.38
C211422	H530mm	£99.06	£67.36	£64.38
C211423	H590mm	£99.06	£67.36	£64.38
C211424	H640mm	£99.06	£67.36	£64.38
C211425	H710mm	£99.06	£67.36	£64.38
C211426	H760mm	£99.06	£67.36	£64.38

- Crushbent Frame

		1-2	3-14	15+
C211431	H460mm	£99.06	£67.36	£64.38
C211432	H530mm	£99.06	£67.36	£64.38
C211433	H590mm	£99.06	£67.36	£64.38
C211434	H640mm	£99.06	£67.36	£64.38
C211435	H710mm	£99.06	£67.36	£64.38
C211436	H760mm	£99.06	£67.36	£64.38

1100 x 550mm Rectangular



- Fully Welded Frame

		1-2	3-14	15+
C211441	H460mm	£98.81	£67.19	£64.32
C211442	H530mm	£98.81	£67.19	£64.32
C211443	H590mm	£98.81	£67.19	£64.32
C211444	H640mm	£98.81	£67.19	£64.32
C211445	H710mm	£98.81	£67.19	£64.32
C211446	H760mm	£98.81	£67.19	£64.32

- Crushbent Frame

		1-2	3-14	15+
C211451	H460mm	£98.81	£67.19	£64.32
C211452	H530mm	£98.81	£67.19	£64.32
C211453	H590mm	£98.81	£67.19	£64.32
C211454	H640mm	£98.81	£67.19	£64.32
C211455	H710mm	£98.81	£67.19	£64.32
C211456	H760mm	£98.81	£67.19	£64.32

1100 x 550mm Trapezoidal



- Fully Welded Frame

		1-2	3-14	15+
C211461	H460mm	£104.86	£71.31	£68.14
C211462	H530mm	£104.86	£71.31	£68.14
C211463	H590mm	£104.86	£71.31	£68.14
C211464	H640mm	£104.86	£71.31	£68.14
C211465	H710mm	£104.86	£71.31	£68.14
C211466	H760mm	£104.86	£71.31	£68.14

- Crushbent Frame

		1-2	3-14	15+
C211471	H460mm	£104.86	£71.31	£68.14
C211472	H530mm	£104.86	£71.31	£68.14
C211473	H590mm	£104.86	£71.31	£68.14
C211474	H640mm	£104.86	£71.31	£68.14
C211475	H710mm	£104.86	£71.31	£68.14
C211476	H760mm	£104.86	£71.31	£68.14



600 x 600mm Square

- Fully Welded Frame

		1-2	3-14	15+
C211481	H460mm	£84.24	£57.28	£54.75
C211482	H530mm	£84.24	£57.28	£54.75
C211483	H590mm	£84.24	£57.28	£54.75
C211484	H640mm	£84.24	£57.28	£54.75
C211485	H710mm	£84.24	£57.28	£54.75
C211486	H760mm	£84.24	£57.28	£54.75

- Crushbent Frame

		1-2	3-14	15+
C211491	H460mm	£84.24	£57.28	£54.75
C211492	H530mm	£84.24	£57.28	£54.75
C211493	H590mm	£84.24	£57.28	£54.75
C211494	H640mm	£84.24	£57.28	£54.75
C211495	H710mm	£84.24	£57.28	£54.75
C211496	H760mm	£84.24	£57.28	£54.75



1000mm Diameter Circular

- Circular tables not stackable

- Fully Welded Frame

		1-2	3-14	15+
C211511	H460mm	£147.39	£100.23	£95.80
C211512	H530mm	£147.39	£100.23	£95.80
C211513	H590mm	£147.39	£100.23	£95.80
C211514	H640mm	£147.39	£100.23	£95.80
C211515	H710mm	£147.39	£100.23	£95.80
C211516	H760mm	£147.39	£100.23	£95.80

- Crushbent Frame

		1-2	3-14	15+
C211521	H460mm	£147.39	£100.23	£95.80
C211522	H530mm	£147.39	£100.23	£95.80
C211523	H590mm	£147.39	£100.23	£95.80
C211524	H640mm	£147.39	£100.23	£95.80
C211525	H710mm	£147.39	£100.23	£95.80
C211526	H760mm	£147.39	£100.23	£95.80



Also available in 1100mm and 1200mm diameter, please call for details

1200 x 600mm Diameter Semi-Circular

- Fully Welded Frame

		1-2	3-14	15+
C211531	H460mm	£127.91	£86.98	£83.13
C211532	H530mm	£127.91	£86.98	£83.13
C211533	H590mm	£127.91	£86.98	£83.13
C211534	H640mm	£127.91	£86.98	£83.13
C211535	H710mm	£127.91	£86.98	£83.13
C211536	H760mm	£127.91	£86.98	£83.13

- Crushbent Frame

		1-2	3-14	15+
C211541	H460mm	£127.91	£86.98	£83.13
C211542	H530mm	£127.91	£86.98	£83.13
C211543	H590mm	£127.91	£86.98	£83.13
C211544	H640mm	£127.91	£86.98	£83.13
C211545	H710mm	£127.91	£86.98	£83.13
C211546	H760mm	£127.91	£86.98	£83.13



1100 x 550mm Diameter Semi-Circular

- Fully Welded Frame

		1-2	3-14	15+
C211551	H460mm	£125.47	£85.32	£81.55
C211552	H530mm	£125.47	£85.32	£81.55
C211553	H590mm	£125.47	£85.32	£81.55
C211554	H640mm	£125.47	£85.32	£81.55
C211555	H710mm	£125.47	£85.32	£81.55
C211556	H760mm	£125.47	£85.32	£81.55

- Crushbent Frame

		1-2	3-14	15+
C211561	H460mm	£125.47	£85.32	£81.55
C211562	H530mm	£125.47	£85.32	£81.55
C211563	H590mm	£125.47	£85.32	£81.55
C211564	H640mm	£125.47	£85.32	£81.55
C211565	H710mm	£125.47	£85.32	£81.55
C211566	H760mm	£125.47	£85.32	£81.55



The guides below show the measurements of each sizemark and age and stature ranges they are suitable for. This information is for guidance only. It is based on average pupil size across the EU. **Customers must ensure sizes are correct for their individual requirements**

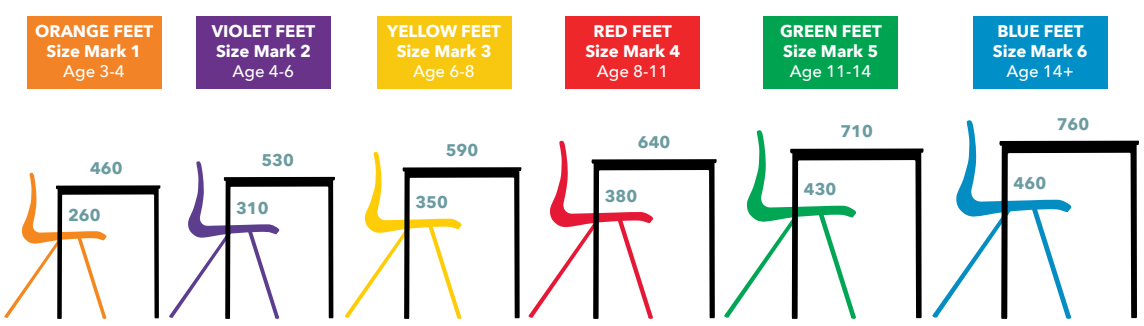

Table/chair sizes may vary slightly from the sizes shown. The standard allows heights to be within a 10mm tolerance.



Welded Frame Classroom Tray Tables

- The same quality tables as the preceding ranges, tray tables are fitted with runners and pull out trays providing individual storage for students
- Trays give extra scope for attractive colour schemes - see below for tray colour options
- Please check pupils will have sufficient leg room under tray tables; you may wish to move up a size
- **Please see Important Furniture Ordering Information on page 306 before placing your furniture order**

Please Specify:

1. Top colour
2. Edge type & colour
3. Frame colour
4. Tray colour

Laminate Top Colours

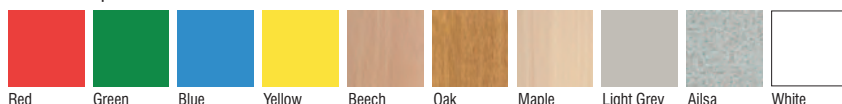

Tray Colour Options



PU Edge Colours



Frame Colours

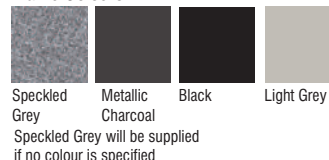

1200 x 600mm Rectangular

- MDF Edge

		1-2	3-14	15+
C211571	H460mm	£119.73	£81.42	£77.82
C211572	H530mm	£119.73	£81.42	£77.82
C211573	H590mm	£119.73	£81.42	£77.82
C211574	H640mm	£119.73	£81.42	£77.82
C211575	H710mm	£119.73	£81.42	£77.82
C211576	H760mm	£119.73	£81.42	£77.82

- PU Edge

		1-2	3-14	15+
C211591	H460mm	£138.12	£93.92	£89.76
C211592	H530mm	£138.12	£93.92	£89.76
C211593	H590mm	£138.12	£93.92	£89.76
C211594	H640mm	£138.12	£93.92	£89.76
C211595	H710mm	£138.12	£93.92	£89.76
C211596	H760mm	£138.12	£93.92	£89.76

1100 x 550mm Rectangular

- MDF Edge

		1-2	3-14	15+
C211611	H460mm	£120.54	£81.97	£78.34
C211612	H530mm	£120.54	£81.97	£78.34
C211613	H590mm	£120.54	£81.97	£78.34
C211614	H640mm	£120.54	£81.97	£78.34
C211615	H710mm	£120.54	£81.97	£78.34
C211616	H760mm	£120.54	£81.97	£78.34

- PU Edge

		1-2	3-14	15+
C211631	H460mm	£138.12	£93.92	£89.76
C211632	H530mm	£138.12	£93.92	£89.76
C211633	H590mm	£138.12	£93.92	£89.76
C211634	H640mm	£138.12	£93.92	£89.76
C211635	H710mm	£138.12	£93.92	£89.76
C211636	H760mm	£138.12	£93.92	£89.76

600 x 600mm Square

- MDF Edge

		1-2	3-14	15+
C211641	H460mm	£89.86	£61.10	£58.40
C211642	H530mm	£89.86	£61.10	£58.40
C211643	H590mm	£89.86	£61.10	£58.40
C211644	H640mm	£89.86	£61.10	£58.40
C211645	H710mm	£89.86	£61.10	£58.40
C211646	H760mm	£89.86	£61.10	£58.40

- PU Edge

		1-2	3-14	15+
C211661	H460mm	£102.98	£70.02	£66.92
C211662	H530mm	£102.98	£70.02	£66.92
C211663	H590mm	£102.98	£70.02	£66.92
C211664	H640mm	£102.98	£70.02	£66.92
C211665	H710mm	£102.98	£70.02	£66.92
C211666	H760mm	£102.98	£70.02	£66.92



Express Delivery Classroom Tables

- High quality UK manufactured tables
- 32mm diameter, stylish round tube legs in grey finish
- EN1729 compliant
- Heights 710mm or 760mm
- MDF edge and PU edge options
- Standard delivery 1-2 weeks, please check at time of ordering
- **Please see Important Furniture Ordering Information on page 306 before placing your furniture order**



Please Specify:

Top colour

Top Colours



Beech Grey

Express
1-2 week
delivery



Grade Rectangular MDF Edge

- 18mm laminated top, MDF edge
- 1200 x 600mm
- 10 year guarantee

		1-2	3-14	15+
C211671	H710mm, Beech Top	£93.55	£73.40	£66.06
C211672	H710mm, Grey Top	£93.55	£73.40	£66.06
C211673	H760mm, Beech Top	£93.55	£73.40	£66.06
C211674	H760mm, Grey Top	£93.55	£73.40	£66.06



Grade Square MDF Edge

- 18mm laminated top, MDF edge
- 600 x 600mm
- 10 year guarantee

		1-2	3-14	15+
C211681	H10mm, Beech Top	£75.11	£58.93	£53.04
C211682	H710mm, Grey Top	£75.11	£58.93	£53.04
C211683	H760mm, Beech Top	£75.11	£58.93	£53.04
C211684	H760mm, Grey Top	£75.11	£58.93	£53.04

Grade Rectangular PU Edge

- 18mm laminated top, grey spray PU edge
- 1200 x 600mm
- 10 year guarantee

		1-2	3-14	15+
C211691	H710mm, Beech Top	£96.13	£75.42	£67.88
C211692	H710mm, Grey Top	£96.13	£75.42	£67.88
C211693	H760mm, Beech Top	£96.13	£75.42	£67.88
C211694	H760mm, Grey Top	£96.13	£75.42	£67.88

Grade Square PU Edge

- 18mm laminated top, grey spray PU edge
- 600 x 600mm
- 10 year guarantee

		1-2	3-14	15+
C211711	H710mm, Beech Top	£82.63	£64.83	£58.35
C211712	H710mm, Grey Top	£82.63	£64.83	£58.35
C211713	H760mm, Beech Top	£82.63	£64.83	£58.35
C211714	H760mm, Grey Top	£82.63	£64.83	£58.35



CALL US ON 01527 878348



VISIT WWW.FORWARDPRODUCTS.CO.UK



Ultimate Classroom Tables

- Premium quality crushbent frame tables
- Solid 18mm MDF core high pressure laminated tops
- High impact, resilient textured spray PU edge with a unique waterfall shaped finish
- Robust 28mm stacking crushbent frames
- 5 year guarantee
- **Please see Important Furniture Ordering Information on page 306 before placing your furniture order**

Crushbent frames - slide stacking 8 high



Please Specify:

1. Top colour
2. Edge colour
3. Frame colour

Laminate Top Colours

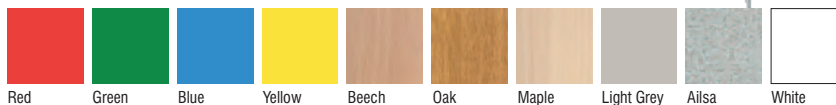

PU Edge Colours



Frame Colours

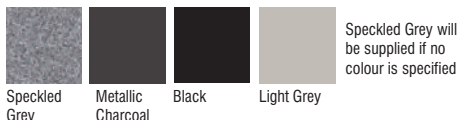

1200 x 600mm Rectangular

		1-2	3-14	15+
C211721	H460mm	£139.15	£94.62	£90.44
C211722	H530mm	£139.15	£94.62	£90.44
C211723	H590mm	£139.15	£94.62	£90.44
C211724	H640mm	£139.15	£94.62	£90.44
C211725	H710mm	£139.15	£94.62	£90.44
C211726	H760mm	£139.15	£94.62	£90.44

1200 x 600mm Trapezoidal

		1-2	3-14	15+
C211731	H460mm	£142.72	£97.05	£92.75
C211732	H530mm	£142.72	£97.05	£92.75
C211733	H590mm	£142.72	£97.05	£92.75
C211734	H640mm	£142.72	£97.05	£92.75
C211735	H710mm	£142.72	£97.05	£92.75
C211736	H760mm	£142.72	£97.05	£92.75

600 x 600mm Square

		1-2	3-14	15+
C211741	H460mm	£105.42	£71.69	£68.51
C211742	H530mm	£105.42	£71.69	£68.51
C211743	H590mm	£105.42	£71.69	£68.51
C211744	H640mm	£105.42	£71.69	£68.51
C211745	H710mm	£105.42	£71.69	£68.51
C211746	H760mm	£105.42	£71.69	£68.51

1000mm Diameter Circular

		1-2	3-14	15+
C211751	H460mm	£187.32	£127.37	£121.74
C211752	H530mm	£187.32	£127.37	£121.74
C211753	H590mm	£187.32	£127.37	£121.74
C211754	H640mm	£187.32	£127.37	£121.74
C211755	H710mm	£187.32	£127.37	£121.74
C211756	H760mm	£187.32	£127.37	£121.74





Premium Early Years Tables

- Chunky design and bright colours, ideal for nursery and primary classrooms
- Highest quality fully welded tables with stylish, chunky 45mm tubular legs
- Standard 18mm tops in hard wearing laminate with MDF bullnosed edges
- Exceptional strength and style vastly superior to bolt-on and screw-on leg systems
- Primary colours will be supplied with a matching frame if no colour is specified
- **Please see Important Furniture Ordering Information on page 306 before placing your furniture order**

Rectangular		1-2	3-14	15+
C211761	1100 x 550 x H460mm	£137.66	£93.61	£91.25
C211762	1100 x 550 x H530mm	£137.66	£93.61	£91.25
C211763	1100 x 550 x H590mm	£137.66	£93.61	£91.25

Trapezoidal		1-2	3-14	15+
C211764	1100 x 550 x H460mm	£144.29	£98.12	£95.64
C211765	1100 x 550 x H530mm	£144.29	£98.12	£95.64
C211766	1100 x 550 x H590mm	£144.29	£98.12	£95.64

Circular		1-2	3-14	15+
C211767	1100 dia. x H460mm	£192.19	£130.69	£127.39
C211768	1100 dia. x H530mm	£192.19	£130.69	£127.39
C211769	1100 dia. x H590mm	£192.19	£130.69	£127.39

- PU edges also available, please call for prices

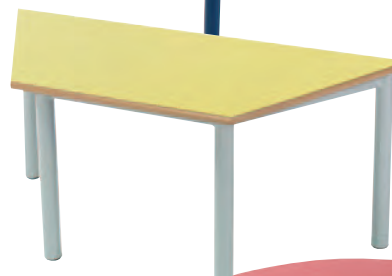

FULLY EN1729 COMPLIANT



Please Specify:

1. Top colour
2. Frame colour

Laminate Top Colours supplied with matching colour frames

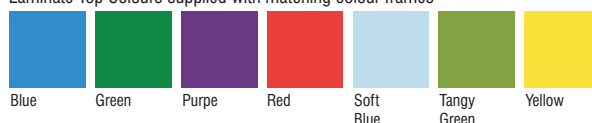

Laminate Top Colours supplied with Duraform Light Speckled Grey Frame

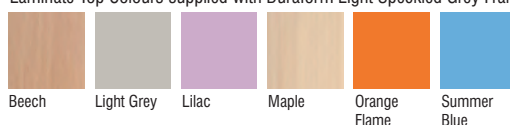

Frame Colour



CALL US ON 01527 878348



VISIT WWW.FORWARDPRODUCTS.CO.UK



Dura Premium Tables

- High quality fully welded tables with stylish 32mm legs
- Exceptional strength and style vastly superior to bolt-on and screw-on leg systems
- Hardwearing 18mm laminated tops
- Choose from a lacquered, bullnosed MDF edge or spray moulded PU edge
- 5 year guarantee
- **Please see Important Furniture Ordering Information on page 306 before placing your furniture order**

Please Specify:

1. Top colour
2. Edge colour
3. Frame colour

Laminate Top Colours

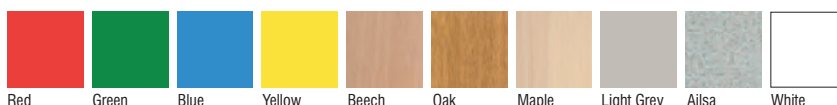

PU Edge Colours



Frame Colours

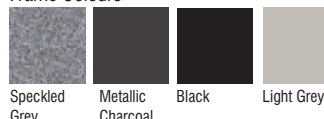

Speckled Grey will be supplied if no colour is specified

1200 x 600mm Rectangular



MDF Edge

		1-2	3-14	15+
C211771	H460mm	£94.20	£70.65	£62.64
C211772	H530mm	£94.20	£70.65	£62.64
C211773	H590mm	£94.20	£70.65	£62.64
C211774	H640mm	£94.20	£70.65	£62.64
C211775	H710mm	£94.20	£70.65	£62.64
C211776	H760mm	£94.20	£70.65	£62.64

PU Edge

		1-2	3-14	15+
C211781	H460mm	£109.94	£82.45	£73.11
C211782	H530mm	£109.94	£82.45	£73.11
C211783	H590mm	£109.94	£82.45	£73.11
C211784	H640mm	£109.94	£82.45	£73.11
C211785	H710mm	£109.94	£82.45	£73.11
C211786	H760mm	£109.94	£82.45	£73.11

1100 x 550mm Rectangular



MDF Edge

		1-2	3-14	15+
C211791	H460mm	£94.20	£70.65	£62.64
C211792	H530mm	£94.20	£70.65	£62.64
C211793	H590mm	£94.20	£70.65	£62.64
C211794	H640mm	£94.20	£70.65	£62.64
C211795	H710mm	£94.20	£70.65	£62.64
C211796	H760mm	£94.20	£70.65	£62.64

PU Edge

		1-2	3-14	15+
C211811	H460mm	£109.94	£82.45	£73.11
C211812	H530mm	£109.94	£82.45	£73.11
C211813	H590mm	£109.94	£82.45	£73.11
C211814	H640mm	£109.94	£82.45	£73.11
C211815	H710mm	£109.94	£82.45	£73.11
C211816	H760mm	£109.94	£82.45	£73.11

1100 x 550mm Trapezoidal



MDF Edge

		1-2	3-14	15+
C211821	H460mm	£94.20	£70.65	£62.64
C211822	H530mm	£94.20	£70.65	£62.64
C211823	H590mm	£94.20	£70.65	£62.64
C211824	H640mm	£94.20	£70.65	£62.64
C211825	H710mm	£94.20	£70.65	£62.64
C211826	H760mm	£94.20	£70.65	£62.64

PU Edge

		1-2	3-14	15+
C211831	H460mm	£109.94	£82.45	£73.11
C211832	H530mm	£109.94	£82.45	£73.11
C211833	H590mm	£109.94	£82.45	£73.11
C211834	H640mm	£109.94	£82.45	£73.11
C211835	H710mm	£109.94	£82.45	£73.11
C211836	H760mm	£109.94	£82.45	£73.11





600 x 600mm Square

MDF Edge

		1-2	3-14	15+
C211841	H460mm	£73.00	£49.64	£48.38
C211842	H530mm	£73.00	£49.64	£48.38
C211843	H590mm	£73.00	£49.64	£48.38
C211844	H640mm	£73.00	£49.64	£48.38
C211845	H710mm	£73.00	£49.64	£48.38
C211846	H760mm	£73.00	£49.64	£48.38

PU Edge

		1-2	3-14	15+
C211851	H460mm	£93.24	£63.41	£61.80
C211852	H530mm	£93.24	£63.41	£61.80
C211853	H590mm	£93.24	£63.41	£61.80
C211854	H640mm	£93.24	£63.41	£61.80
C211855	H710mm	£93.24	£63.41	£61.80
C211856	H760mm	£93.24	£63.41	£61.80



1200mm Diameter Circular

MDF Edge

		1-2	3-14	15+
C211861	H460mm	£168.39	£124.94	£115.92
C211862	H530mm	£168.39	£124.94	£115.92
C211863	H590mm	£168.39	£124.94	£115.92
C211864	H640mm	£168.39	£124.94	£115.92
C211865	H710mm	£168.39	£124.94	£115.92
C211866	H760mm	£168.39	£124.94	£115.92

PU Edge

		1-2	3-14	15+
C211871	H460mm	£203.34	£138.27	£134.79
C211872	H530mm	£203.34	£138.27	£134.79
C211873	H590mm	£203.34	£138.27	£134.79
C211874	H640mm	£203.34	£138.27	£134.79
C211875	H710mm	£203.34	£138.27	£134.79
C211876	H760mm	£203.34	£138.27	£134.79



Also available in 1100mm diameter, please call for details

1200 x 600mm Diameter Semi-Circular

MDF Edge

		1-2	3-14	15+
C211881	H460mm	£99.80	£67.87	£66.15
C211882	H530mm	£99.80	£67.87	£66.15
C211883	H590mm	£99.80	£67.87	£66.15
C211884	H640mm	£99.80	£67.87	£66.15
C211885	H710mm	£99.80	£67.87	£66.15
C211886	H760mm	£99.80	£67.87	£66.15

PU Edge

		1-2	3-14	15+
C211891	H460mm	£124.48	£84.64	£82.51
C211892	H530mm	£124.48	£84.64	£82.51
C211893	H590mm	£124.48	£84.64	£82.51
C211894	H640mm	£124.48	£84.64	£82.51
C211895	H710mm	£124.48	£84.64	£82.51
C211896	H760mm	£124.48	£84.64	£82.51



1100 x 550mm Diameter Semi-Circular

MDF Edge

		1-2	3-14	15+
C211911	H460mm	£99.80	£67.87	£66.15
C211912	H530mm	£99.80	£67.87	£66.15
C211913	H590mm	£99.80	£67.87	£66.15
C211914	H640mm	£99.80	£67.87	£66.15
C211915	H710mm	£99.80	£67.87	£66.15
C211916	H760mm	£99.80	£67.87	£66.15

PU Edge

		1-2	3-14	15+
C211921	H460mm	£118.91	£80.86	£78.83
C211922	H530mm	£118.91	£80.86	£78.83
C211923	H590mm	£118.91	£80.86	£78.83
C211924	H640mm	£118.91	£80.86	£78.83
C211925	H710mm	£118.91	£80.86	£78.83
C211926	H760mm	£118.91	£80.86	£78.83





Spectrum Heavy Duty Tables

- Stylish tables built to withstand high levels of wear and tear
- Premium 25mm thick top with spray PU edges
- 32mm tubular curved leg frames with height adjustable feet and tamperproof fixings
- 10 year guarantee
- **Please see Important Furniture Ordering Information on page 306 before placing your furniture order**

Please Specify:

1. Top colour
2. Edge colour
3. Frame colour

Laminate Top Colours

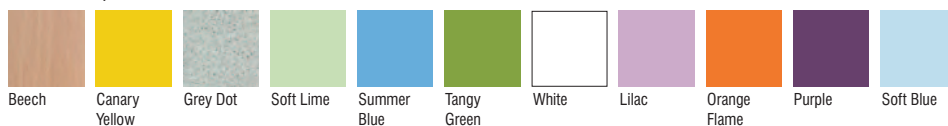

PU Edge Colours



Frame Colours

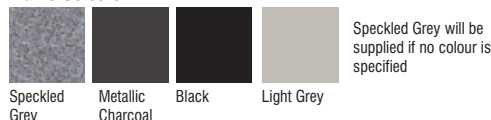

Please call for prices on bulk quantities



1100 x 550mm Rectangular

		1-2	3-14	15+
C211931	H460mm	£166.71	£113.36	£109.96
C211932	H530mm	£166.71	£113.36	£109.96
C211933	H590mm	£166.71	£113.36	£109.96
C211934	H640mm	£166.71	£113.36	£109.96
C211935	H710mm	£166.71	£113.36	£109.96
C211936	H760mm	£166.71	£113.36	£109.96

1200 x 600mm Rectangular

		1-2	3-14	15+
C211941	H460mm	£168.58	£114.63	£111.19
C211942	H530mm	£168.58	£114.63	£111.19
C211943	H590mm	£168.58	£114.63	£111.19
C211944	H640mm	£168.58	£114.63	£111.19
C211945	H710mm	£168.58	£114.63	£111.19
C211946	H760mm	£168.58	£114.63	£111.19

1100 x 550mm Trapezoidal

		1-2	3-14	15+
C211951	H460mm	£166.71	£113.36	£109.96
C211952	H530mm	£166.71	£113.36	£109.96
C211953	H590mm	£166.71	£113.36	£109.96
C211954	H640mm	£166.71	£113.36	£109.96
C211955	H710mm	£166.71	£113.36	£109.96
C211956	H760mm	£166.71	£113.36	£109.96

1200 x 600mm Trapezoidal

		1-2	3-14	15+
C211961	H460mm	£168.58	£114.63	£111.19
C211962	H530mm	£168.58	£114.63	£111.19
C211963	H590mm	£168.58	£114.63	£111.19
C211964	H640mm	£168.58	£114.63	£111.19
C211965	H710mm	£168.58	£114.63	£111.19
C211966	H760mm	£168.58	£114.63	£111.19





600 x 600mm Square

		1-2	3-14	15+
C211971	H460mm	£113.85	£77.42	£75.10
C211972	H530mm	£113.85	£77.42	£75.10
C211973	H590mm	£113.85	£77.42	£75.10
C211974	H640mm	£113.85	£77.42	£75.10
C211975	H710mm	£113.85	£77.42	£75.10
C211976	H760mm	£113.85	£77.42	£75.10

1490 x 600mm Arc

		1-2	3-14	15+
C212141	H460mm	£301.08	£204.74	£198.59
C212142	H530mm	£301.08	£204.74	£198.59
C212143	H590mm	£301.08	£204.74	£198.59
C212144	H640mm	£301.08	£204.74	£198.59
C212145	H710mm	£301.08	£204.74	£198.59
C212146	H760mm	£301.08	£204.74	£198.59

* 2100mm when 4 together to make circular

1100mm Diameter Circular

		1-2	3-14	15+
C211991	H460mm	£303.33	£206.27	£200.07
C211992	H530mm	£303.33	£206.27	£200.07
C211993	H590mm	£303.33	£206.27	£200.07
C211994	H640mm	£303.33	£206.27	£200.07
C211995	H710mm	£303.33	£206.27	£200.07
C211996	H760mm	£303.33	£206.27	£200.07

1200mm Diameter Circular

		1-2	3-14	15+
C212111	H460mm	£374.73	£254.82	£247.18
C212112	H530mm	£374.73	£254.82	£247.18
C212113	H590mm	£374.73	£254.82	£247.18
C212114	H640mm	£374.73	£254.82	£247.18
C212115	H710mm	£374.73	£254.82	£247.18
C212116	H760mm	£374.73	£254.82	£247.18

1100 x 550mm Diameter Semi-Circular

		1-2	3-14	15+
C212121	H460mm	£163.90	£111.45	£108.10
C212122	H530mm	£163.90	£111.45	£108.10
C212123	H590mm	£163.90	£111.45	£108.10
C212124	H640mm	£163.90	£111.45	£108.10
C212125	H710mm	£163.90	£111.45	£108.10
C212126	H760mm	£163.90	£111.45	£108.10

1200 x 600mm Diameter Semi-Circular

		1-2	3-14	15+
C212131	H460mm	£177.77	£120.88	£117.25
C212132	H530mm	£177.77	£120.88	£117.25
C212133	H590mm	£177.77	£120.88	£117.25
C212134	H640mm	£177.77	£120.88	£117.25
C212135	H710mm	£177.77	£120.88	£117.25
C212136	H760mm	£177.77	£120.88	£117.25



CALL US ON 01527 878348



VISIT WWW.FORWARDPRODUCTS.CO.UK

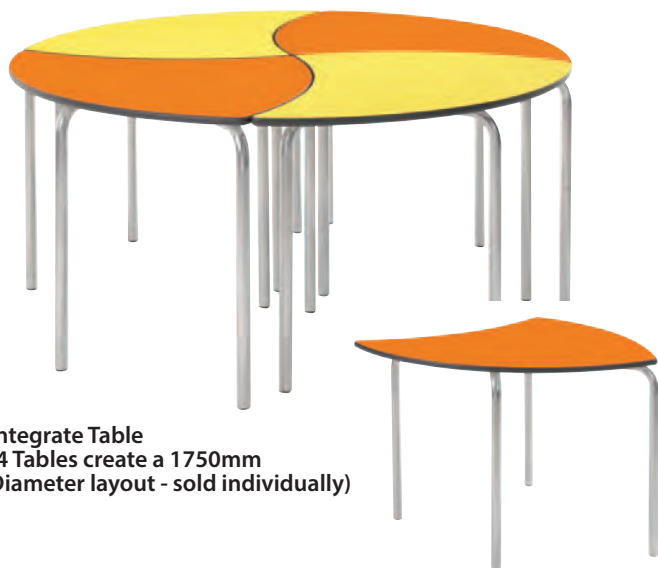

Integrate Table
(4 Tables create a 1750mm Diameter layout - sold individually)

Integrate Tables

- Truly unique shape offers endless creativity
- Size: 1220 x 875mm
- 5 year guarantee
- 25mm premium top with PU edge

		1-2	3-14	15+
C212151	H460mm	£241.29	£125.47	£121.71
C212152	H530mm	£241.29	£125.47	£121.71
C212153	H590mm	£241.29	£125.47	£121.71
C212154	H640mm	£241.29	£125.47	£121.71
C212155	H710mm	£241.29	£125.47	£121.71
C212156	H760mm	£241.29	£125.47	£121.71



Lateral Tables

- Extremely versatile with various shape combinations
- 3 together create a hexagonal shape of 1500mm diameter
- Size: 1400mm x 866mm diameter
- 10 year guarantee
- 25mm premium top with PU edge

		1-2	3-14	15+
C212161	H460mm	£243.58	£126.66	£122.86
C212162	H530mm	£243.58	£126.66	£122.86
C212163	H590mm	£243.58	£126.66	£122.86
C212164	H640mm	£243.58	£126.66	£122.86
C212165	H710mm	£243.58	£126.66	£122.86
C212166	H760mm	£243.58	£126.66	£122.86



Please Specify:

1. Top colour
2. Edge colour
3. Frame colour

Laminate Top Colours

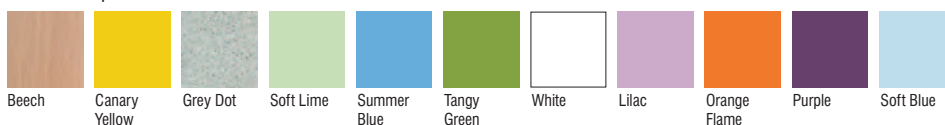

PU Edge Colours



Incredibly tough PU edging is moulded to the MDF core meaning it cannot be prised or picked away.

Frame Colours

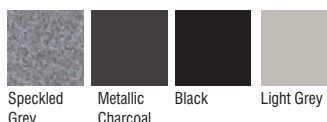

Please see Important Furniture Ordering Information on page 306 before placing your furniture order



Metric Tables

- Exciting new modular table designed to allow maximum flexibility
- Perfect for classrooms, libraries, ICT hot desks or breakout areas
- Size: 750 x 660mm (6 together form a 1635mm diameter circle)
- 5 year guarantee
- 18mm laminate top with PU edge
- Please specify top colour, edge colour and frame colour when ordering (see previous page for options)

		1-2	3-14	15+
C212181	H460mm	£136.44	£86.98	£84.37
C212182	H530mm	£136.44	£86.98	£84.37
C212183	H590mm	£136.44	£86.98	£84.37
C212184	H640mm	£136.44	£86.98	£84.37
C212185	H710mm	£136.44	£86.98	£84.37
C212186	H760mm	£136.44	£86.98	£84.37



All tables are available with drywipe table tops

Please see previous page for colour options

Please see Important Furniture Ordering Information on page 306 before placing your furniture order

Puzzle Tables

- Flexible and dynamic modular table with endless configuration possibilities
- Designed to seat 1 but can seat up to 3 when full working space is not essential
- Size: 940 x 890mm
- 5 year guarantee
- 18mm laminate top with PU edge
- Please specify top colour, edge colour and frame colour when ordering (see previous page for options)

		1-2	3-14	15+
C212171	H460mm	£163.83	£104.44	£101.31
C212172	H530mm	£163.83	£104.44	£101.31
C212173	H590mm	£163.83	£104.44	£101.31
C212174	H640mm	£163.83	£104.44	£101.31
C212175	H710mm	£163.83	£104.44	£101.31
C212176	H760mm	£163.83	£104.44	£101.31



CALL US ON 01527 878348



VISIT WWW.FORWARDPRODUCTS.CO.UK



Please Specify:

1. Top colour
2. Edge style & colour
3. Frame colour
4. Table height

Laminate Top Colours

Ailsa Blue Beech Light Grey White

Edge Styles

MDF Edge
Bullnosed, polished & lacquered

PU Edge
High impact, resilient textured spray edge in Charcoal or Light Grey

Trespa
Chamfered edge as standard. Chemical & heat resistant

Craft Tables

- High quality comprehensive range of tables
- Perfect for art, food tech, science and craft environments
- Wide range of top, edge and frame finishes to complement any colour schemes
- Many heights available to suit all ages
- Please specify top colour, edge colour (if necessary), frame colour and table height when ordering
- **Please see Important Furniture Ordering Information on page 306 before placing your furniture order**

Trespa Top Colour

Speckled Icy Blue Speckled Pastel Grey Speckled Powder Blue Speckled White White

Frame Colours - Speckled Grey will be supplied if no colour is specified

Speckled Grey Metallic Charcoal Black Light Grey Silver POA

Fully Welded Craft Table

- Heavy duty fully welded H frame
- 25mm square steel tube
- 5 year guarantee
- Other heights available - please call for details

MDF Edge

	W x D x H(mm)	1-2	3-14	15+
C212451	1200 x 600 x 850	£171.42	£126.12	£116.32
C212452	1200 x 750 x 850	£199.41	£146.71	£135.32
C212453	1500 x 750 x 850	£297.36	£218.77	£201.78
C215111	1200 x 600 x 900	£171.42	£126.12	£116.32
C215112	1200 x 750 x 900	£199.41	£146.71	£135.32
C215113	1500 x 750 x 900	£297.59	£218.77	£201.78

PU Edge

	W x D x H(mm)	1-2	3-14	15+
C212454	1200 x 600 x 850	£192.41	£141.56	£130.56
C212455	1200 x 750 x 850	£220.40	£162.15	£149.56
C212456	1500 x 750 x 850	£282.62	£223.92	£206.53
C215114	1200 x 600 x 900	£192.41	£141.56	£130.56
C215115	1200 x 750 x 900	£220.40	£162.15	£149.56
C215116	1500 x 750 x 900	£282.63	£223.92	£206.53



Trespa

	W x D x H(mm)	1-2	3-14	15+
C212457	1200 x 600 x 850	£269.79	£252.62	£233.00
C212458	1200 x 750 x 850	£397.11	£371.84	£342.96
C212459	1500 x 750 x 850	£424.38	£397.38	£366.51
C215117	1200 x 600 x 900	£269.79	£252.62	£233.00
C215118	1200 x 750 x 900	£397.11	£371.84	£342.96
C215119	1500 x 750 x 900	£424.38	£397.38	£366.51

Crushbent Craft Table

- Chunky 28mm crushbent H frame
- 5 year guarantee
- Please specify height required - see details above

MDF Edge

	W x D x H(mm)	1-2	3-14	15+
C212461	1200 x 600 x 850	£171.42	£126.12	£116.32
C212462	1200 x 750 x 850	£199.41	£146.71	£135.32
C212463	1500 x 750 x 850	£297.36	£218.77	£201.78
C215121	1200 x 600 x 900	£171.42	£126.12	£116.32
C215122	1200 x 750 x 900	£199.41	£146.71	£135.32
C215123	1500 x 750 x 900	£297.36	£218.77	£201.78

PU Edge

	W x D x H(mm)	1-2	3-14	15+
C212464	1200 x 600 x 850	£192.41	£141.56	£130.56
C212465	1200 x 750 x 850	£220.40	£162.15	£149.56
C212466	1500 x 750 x 850	£282.62	£223.92	£206.53
C215124	1200 x 600 x 900	£192.41	£141.56	£130.56
C215125	1200 x 750 x 900	£220.40	£162.15	£149.56
C215126	1500 x 750 x 900	£282.63	£223.92	£206.53



Trespa

	W x D x H(mm)	1-2	3-14	15+
C212467	1200 x 600 x 850	£269.79	£252.62	£233.00
C212468	1200 x 750 x 850	£397.11	£371.84	£342.96
C212469	1500 x 750 x 850	£424.38	£397.38	£366.51
C215127	1200 x 600 x 900	£269.79	£252.62	£233.00
C215128	1200 x 750 x 900	£397.11	£371.84	£342.96
C215129	1500 x 750 x 900	£424.38	£397.38	£366.51



Craft Tables

Premium Craft Table

- Stylish 45mm round tube legs
- 10 year guarantee
- Please specify colours and height required - see details on previous page
- **Please see Important Furniture Ordering Information on page 306 before placing your furniture order**



MDF Edge

	W x D x H(mm)	1-2	3-14	15+
C212471	1200 x 600 x 850	£201.15	£158.05	£150.87
C212472	1200 x 750 x 850	£206.16	£193.04	£178.04
C212473	1500 x 750 x 850	£255.63	£239.37	£220.77
C215131	1200 x 600 x 900	£201.15	£158.05	£150.87
C215132	1200 x 700 x 900	£206.16	£193.04	£178.04
C215133	1500 x 750 x 900	£255.63	£239.37	£220.77

PU Edge

	W x D x H(mm)	1-2	3-14	15+
C212474	1200 x 600 x 850	£225.65	£177.29	£169.23
C212475	1200 x 750 x 850	£245.89	£211.06	£194.66
C212476	1500 x 750 x 850	£279.00	£261.24	£240.95
C215134	1200 x 600 x 900	£225.65	£177.29	£169.23
C215135	1200 x 700 x 900	£245.89	£211.06	£194.66
C215136	1500 x 750 x 900	£279.00	£261.24	£240.95



Trespa

	W x D x H(mm)	1-2	3-14	15+
C212477	1200 x 600 x 850	£415.62	£326.56	£311.71
C212478	1200 x 750 x 850	£494.88	£463.39	£427.40
C212479	1500 x 750 x 850	£529.41	£495.72	£457.21
C215137	1200 x 600 x 900	£415.62	£326.56	£311.71
C215138	1200 x 700 x 900	£494.88	£463.39	£427.40
C215139	1500 x 750 x 900	£529.41	£495.72	£457.21

Project Table

- Sturdy tables for all types of projects
- Grey laminated tops
- All 800mm high
- Frame colours: Red, Tangerine, Cyan, Blue, Lime, Apple Green and Grey - Please specify colour when ordering

C212481	W1220 x D1220mm	£439.06
C212482	W1820 x D1220mm	£527.39
C212483	W2420 x D1220mm	£608.13



Frame Colour Options



CALL US ON 01527 878348



VISIT WWW.FORWARDPRODUCTS.CO.UK



Premium Tilt Top Tables

- Designed and constructed to withstand the demands of the modern school environment
- Smooth no-slam action
- Superb strength and stability
- 18mm laminate top with spray PU edges
- Stylish silver frame
- 5 year guarantee
- 710mm high as standard



Rectangular

	W x Dmm	1-2	3-14	15+
C212341	1200 x 600	£414.99	£345.44	£337.71
C212343	1500 x 750	£501.71	£418.12	£407.70
C212344	1600 x 800	£651.46	£542.86	£528.82
C212346	1800 x 800	£658.75	£549.02	£534.44

Circular

	Diameter mm	1-2	3-14	15+
C212351	1100	£497.72	£414.72	£405.27
C212352	1200	£511.49	£426.33	£415.26

Please Specify:

1. Top colour
2. Edge colour

Laminate Top Colours

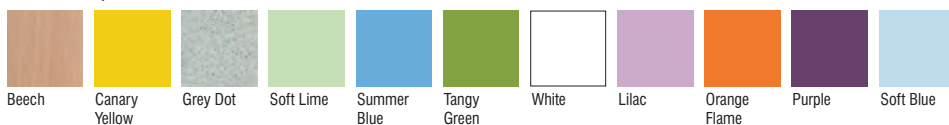

PU Edge Colours

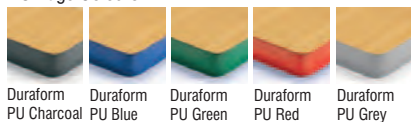

Frame Colour



Height Adjustable Tables

- Durable steel frame and 18mm thick MDF edge laminated tops
- Adjustable between 512 - 805mm high
- Tamperproof fixings
- Side operated removable handle supplied as standard, top operated handle available on request

C212361	Single Desk W750 x D600mm	£287.66
C212362	Double Desk W1200 x D600mm	£323.33



Please Specify:

Top colour



MDF Edge Information
The MDF core is bullnosed and lacquered creating a hardwearing finish that cannot be picked.

Laminate Top Colours



Portholes can be added on request at additional cost



Removable Handle - Top or Side Operated

Please see Important Furniture Ordering Information on page 306 before placing your furniture order

Premium Electric Height Adjustable Tables

- Heavy duty table with stylish enclosed leg design and 18mm thick premium laminated tops with spray PU edge
- Adjustable height motorised (electric powerpoint required)
- Adjustable between 700 - 1150mm high
- DDA compliant
- 5 year guarantee

C212371	W1200 x D750mm	£1024.55
C212372	W1500 x D750mm	£1064.14



Please Specify:

1. Top colour
2. Edge colour

PU Edge Colours



Laminate Top Colours

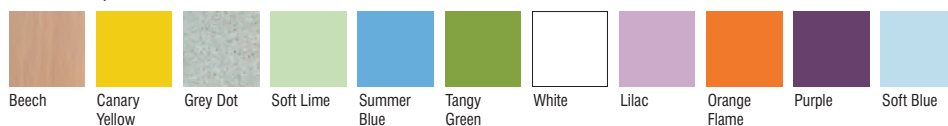

CALL US ON 01527 878348



VISIT WWW.FORWARDPRODUCTS.CO.UK

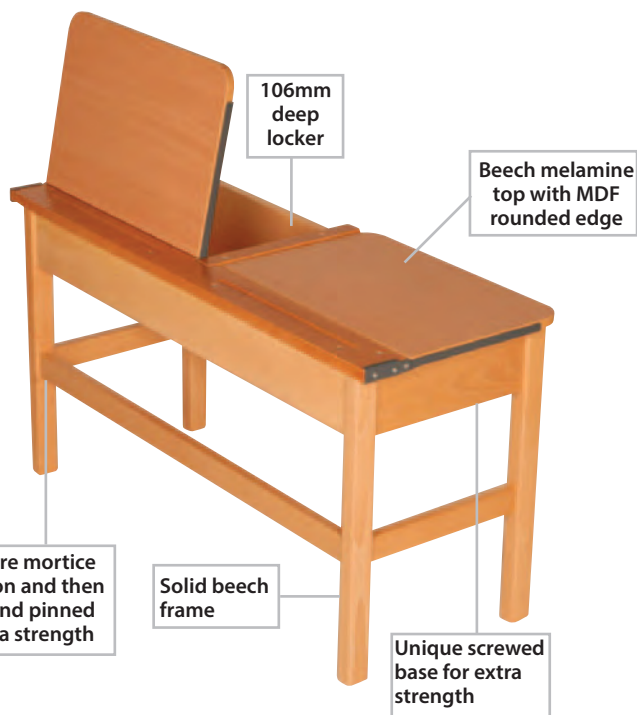

Straight Top Locker Desks

- These traditional desks are still popular throughout education and with good reason as they provide a sturdy, quality, long-lasting solution
- The desk frame is solid beech with mortice and tenon joints, glued and screwed for extra strength
- The desk lid is a beech melamine MDF top providing a matching finish
- The straight top locker desks have a pen groove on the back edge and are available as single or double desks
- The width between the legs is suitable for most chair types, internal width is shown below
- **Please see Important Furniture Ordering Information on page 306 before placing your furniture order**

Double Locker Desks

	W x D x H(mm)	Internal width	
C212431	1100 x 456 x 600	1004mm	£206.98
C212432	1100 x 456 x 650	1004mm	£206.98
C212433	1100 x 456 x 700	1004mm	£206.98
C212434	1100 x 456 x 750	1004mm	£206.98



Did you know?
Beech melamine MDF tops increase the lifespan by three times compared to solid beech tops

Coloured tops are also available to order. Please call for details

Single Locker Desks

	W x D x H(mm)	Internal width	
C212441	600 x 456 x 600	500mm	£141.10
C212442	600 x 456 x 650	500mm	£141.10
C212443	600 x 456 x 700	500mm	£141.10
C212444	600 x 456 x 750	500mm	£141.10



Also available...
...sloping top and stepped locker desks. Please ask for details



Teacher's Pedestal Desks

Single Pedestal Desk

- This popular range of teacher's desks is available in a choice of wood finishes
- Drawers are mounted with metal runners and are fully lockable
- 3 drawer on right side supplied as standard, a 2 drawer pedestal including a filing drawer is also available at the same cost. Pedestals can be fitted on either side, please specify at time of order
- 10 year guarantee



	W x D x H(mm)	
C212311	1200 x 745 x H725mm	£205.71
C212312	1500 x 745 x H725mm	£242.80

Please specify melamine wood finish as shown below

Please Specify:

Wood Finish



Beech

Light Oak



Please see Important Furniture Ordering Information on page 306 before placing your furniture order

Please see further desking and pedestal options on pages 473-486

Double Pedestal Desk

- The double pedestal desk is a long-standing favourite with teachers, providing extra storage and a filing drawer
- Drawers are mounted with metal runners and are lockable
- 10 year guarantee



	W x D x H(mm)	
C212321	1500 x 745 x H725mm	£305.45

Please specify melamine wood finish as shown below

Please Specify:

Wood Finish



Beech

Light Oak





Exam Desks

- Popular range of tried and tested exam furniture
- Choice of standard or premium desks
- Option for beech or grey tops
- Versatile trolleys for easy transportation and storage
- Package deals give great savings
- Available for rapid delivery - please check when ordering
- **Please see Important Furniture Ordering Information on page 306 before placing your furniture order**

Standard Folding Desks

- 600 x 600 x H710mm
- Black frame
- Pen groove
- 15mm MDF edge tops
- Please order in multiples of 2

		2	4-14	16+
C212381	Beech Top Desk	£34.17	£23.23	£22.54
C212382	Grey Top Desk	£36.50	£24.82	£24.08

Premium Folding Desks

- 600 x 600 x H710mm
- Black heavy gauge steel frame
- Pen groove
- 15mm MDF edge tops
- Please order in multiples of 2

		2	4-14	16+
C212391	Beech Top Desk	£43.17	£29.36	£28.48

Trolleys

- Black heavy gauge steel frame
- Locking rubber castors
- Holds up to 25 or 40 desks

C212411	25 Desk Upright Trolley	£186.79
C212412	40 Desk Horizontal Trolley	£209.91

Package Deals

C212421	25 Standard Beech Desks plus Upright Trolley	£662.20
C212422	25 Standard Grey Desks plus Upright Trolley	£687.19
C212423	24 Premium Beech Desks plus Upright Trolley	£724.68
C212424	40 Standard Beech Desks plus Horizontal Trolley	£1052.03
C212425	40 Premium Beech Desks plus Horizontal Trolley	£1169.47



Study Carrels

StudyHub is designed to improve concentration by reducing visual and aural distractions. A flexible, cost effective solution for schools, libraries and IT suites, that are also ideal for commercial offices.

- 18mm top made from grade E1 melamine face high density particle board
- Height levelling feet are supplied as standard
- Supplied with one round, grey coloured cable port
- Pinnable fabric boards are available to purchase separately, in Black, Blue, Ruby or Grey fabric as standard
- Also available in Camira Cara, Carlow or Lucia ranges, please call for details
- Optional extra power port hole available including USB charging, data and media connections, please call for details
- CPU holders also available, please call for details



Study Booth Single

	W x D x H(mm)	
J214611	800 x 800 x 1230	£238.61
J214621	1000 x 800 x 1230	£260.95

Study Booth Extension

	W x D x H(mm)	
J214631	775 x 800 x 1230	£208.78
J214641	975 x 800 x 1230	£231.13

Pinnable Fabric Board

	W x D x H(mm)	
J214651	600 x 200	£38.58
J214661	800 x 200	£40.92

Please Specify:

1. Top colour
2. Fabric colour

Colour Options



Fabric Options

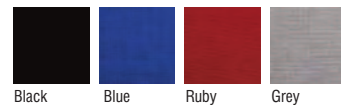

Budget Workstation

- Mobile trolley with lockable castors
- Two fixed shelves
- Supplied flat packed
- W675 x D660 x H725mm

J214821	Workstation	£135.97
---------	-------------	---------



Please see Important Furniture Ordering Information on page 306 before placing your furniture order

Height Adjustable Workstation

- Heavy duty trolley adjustable between 540 - 790mm
- Durable rubber wheels, front 2 braked
- Supplied with four way power unit and lower shelf
- Delivered flat packed
- W1150 x D560 x H540-790mm

J214831	Height Adjustable	£298.16
---------	-------------------	---------



Please Specify:

1. Frame colour

Top

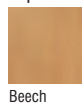

Frame Options

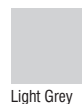
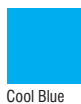



Study Carrels

Many other
classroom table
options available.
Please call for
details



Whiteboard Table



SmartTop Desk



Preparation Table



Woodworking Bench



11

Classroom Storage

Gratnells Trays	355-356
Premium Storage Range	357-360
Storage Systems	361-368
Bookcases	369
Cupboards	370
Coloured Edge Storage	371-372
Modular Storage	373-374
Art Storage	375-376
Maple Storage Range	377-381
Metal Storage	382-383
Lapcabby	384



Trays

- Units come with Gratnells trays included



Castors

- Most units supplied with heavy duty lockable castors



Construction

- Hardwearing MFC units made from SFC and PEFC certified board



Standard Carcass Colours



Beech B Maple M

Premium Carcass Colours



Japanese Ash Birch Light Oak White Red Yellow Blue Green

Minimum quantities and additional costs apply to premium colours - please ask for details

Classroom Storage Range

Free Unwrap and Check Service

- Our experienced delivery drivers are trained to place units into position, unwrap them, remove the packaging and check for any damages
- Applies to ground floor deliveries, please call for details on first and second floor deliveries

Pre-Assembly Service

- Our units are delivered fully assembled saving you time

Rapid Delivery

- The typical lead time is just 10-15 working days; this can extend over the summer months, please call for details

Durability & Longevity

- All units are manufactured in the UK from high quality materials
- Save the environment choosing our storage units - our manufacturer recycles 100% of their paper, plastic and cardboard waste and burns wood waste to heat the factory

Carcass Colours

- Beech or Maple carcasses are supplied as standard
- Premium colours available - please call for pricing



Gratnells Storage Trays

Gratnells trays are supplied free with the storage units on the following pages. Simply specify your preferred choice of tray sizes and colours when ordering.

Colour Chart

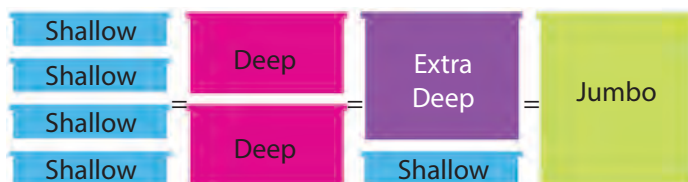



Premium Range Tray Units

- High quality UK manufactured range
- Provides a sleek fitted furniture look from individual pieces
- Grattells trays supplied free of charge with these units – see page 356 for colour options
- Contemporary white or light grey carcasses
- Available with or without lockable castors and doors
- **Please see Important Furniture Ordering Information on page 306 before placing your furniture order**
- When ordering please specify:
 1. Carcass colour - Grey or White
 2. Tray colour – see page 356 for colour options



Premium 6 Shallow Tray Unit

- W363 x D475 x H617mm

C213100	With Castors No Door	£114.81
C213101	Static No Door	£114.81
C213102	With Castors & Door	£137.78
C213103	Static With Door	£137.78

* Please specify carcass colour and tray colours



Premium 8 Shallow Tray Unit

- W363 x D475 x H789mm

C213104	With Castors No Door	£122.47
C213105	Static No Door	£122.47
C213106	With Castors & Door	£145.44
C213107	Static With Door	£145.44

* Please specify carcass colour and tray colours



Premium Range Tray Units

- High quality UK manufactured range
- Provides a sleek fitted furniture look from individual pieces
- Gratnells trays supplied free of charge with these units – see page 356 for colour options
- Contemporary white or light grey carcasses
- Available with or without lockable castors and doors
- **Please see Important Furniture Ordering Information on page 306 before placing your furniture order**
- When ordering please specify:
 1. Carcass colour - Grey or White
 2. Tray colour – see page 356 for colour options



Gratnells trays supplied free of charge with all units - see page 356 for colours

Premium 12 Shallow Tray Unit

- W704 x D475 x H617mm

C213108	With Castors No Doors	£168.39
C213109	Static No Doors	£168.39
C213110	With Castors & Doors	£199.01
C213111	Static With Doors	£199.01

* Please specify carcass colour and tray colours



Premium 16 Shallow Tray Unit

- W704 x D475 x H789mm

C213112	With Castors No Doors	£183.70
C213113	Static No Doors	£183.70
C213114	With Castors & Doors	£214.32
C213115	Static With Doors	£214.32

* Please specify carcass colour and tray colours



Premium 18 Shallow Tray Unit

- W1045 x D475 x H617mm

C213116	With Castors No Doors	£229.62
C213117	Static No Doors	£229.62
C213118	With Castors & Doors	£267.90
C213119	Static With Doors	£267.90

* Please specify carcass colour and tray colours



Premium 24 Shallow Tray Unit

- W1045 x D475 x H789mm

C213120	With Castors No Doors	£267.90
C213125	Static No Doors	£267.90
C213126	With Castors & Doors	£313.82
C213127	Static With Doors	£313.82

* Please specify carcass colour and tray colours



Gratnells trays supplied free of charge with tray units - see page 356 for colours



Premium Range

- High quality UK manufactured range
- Provides a sleek fitted furniture look from individual pieces
- Gratnells trays supplied free of charge with these units – see page 356 for colour options
- Contemporary white or light grey carcasses
- Available with or without lockable castors and doors
- **Please see Important Furniture Ordering Information on page 306 before placing your furniture order**
- When ordering please specify:
 1. Carcass colour - Grey or White
 2. Tray colour – see page 356 for colour options

Premium 6 Shallow Tray Unit

2 Adjustable Shelves

- W1045 x D475 x H617mm

C213128	With Castors No Doors	£214.32
C213129	Static No Doors	£214.32
C213130	With Castors & Doors	£252.59
C213135	Static With Doors	£252.59

* Please specify carcass colour and tray colours

Premium 8 Shallow Tray Unit

2 Adjustable Shelves

- W1045 x D475 x H789mm

C213136	With Castors No Doors	£244.93
C213137	Static No Doors	£244.93
C213138	With Castors & Doors	£290.86
C213139	Static With Doors	£290.86

* Please specify carcass colour and tray colours

Premium Storage Bookcase

2 Adjustable Shelves

- W1045 x D475 x H617mm

C213140	With Castors No Doors	£199.01
C213145	Static No Doors	£199.01

2 Adjustable Shelves

- W1045 x D475 x H789mm

C213148	With Castors No Doors	£221.97
C213149	Static No Doors	£221.97

1 Fixed Shelf & 4 Adjustable Shelves

- W1045 x D475 x H1818mm

C213155	Static	£260.25
---------	--------	---------

* Please specify carcass colour





Premium Range

- Same quality range as Premium Range tray units
- Adjustable shelves and lockable doors
- Combination unit comes with Gratnells trays – see page 356 for tray colour options
- Contemporary white or light grey carcasses
- Lower cupboards available with or without lockable castors
- **Please see Important Furniture Ordering Information on page 306 before placing your furniture order**
- When ordering please specify:
 1. Carcass colour - Grey or White
 2. Tray colour – see page 356 for colour options



Premium Cupboard

2 Adjustable Shelves

- W1045 x D475 x H617mm

C213146	With Castors & Doors	£229.62
C213147	Static with Doors	£229.62

2 Adjustable Shelves

- W1045 x D475 x H789mm

C213150	With Castors & Doors	£252.59
C213153	Static with Doors	£252.59

1 Fixed Shelf & 4 Adjustable Shelves

- W1045 x D475 x H1818mm

C213156	Static	£306.17
---------	--------	---------

* Please specify carcass colour

Premium 21 Shallow Tray Storage Cupboard

2 Adjustable Shelves

- W1045 x D475 x H1818mm

C213154	Static	£535.79
---------	--------	---------

* Please specify carcass colour and tray colours





Gratnells trays supplied free of charge with all units - see page 356 for colours



Best Selling Storage Units

- Great quality tray units
- Manufactured in the UK
- Gratnells trays supplied free of charge with all units - see page 356 for colour options
- Please call for prices on premium colours
- **Please see Important Furniture Ordering Information on page 306 before placing your furniture order**

6 Tray Unit

- W360 x D453 x H617mm

C213191*	6 Tray Unit - No Door	£91.25
C213192*	6 Tray Unit - With Door	£137.05

* Please specify carcass colour and tray colours

12 Tray Unit

- W700 x D453 x H617mm

C213211*	12 Tray Unit - No Doors	£135.84
C213212*	12 Tray Unit - With Doors	£222.00

* Please specify carcass colour and tray colours

18 Tray Unit

- W1030 x D453 x H635mm

C213221*	18 Tray Unit - No Doors	£153.74
C213222*	18 Tray Unit - With Doors	£234.33

* Please specify carcass colour and tray colours

Please Specify:

1. Standard Carcass Colours - Beech or Maple
2. Tray colour required - see page 356 for colour options

Standard Carcass Colours



Beech *B Maple *M

Premium Carcass Colours



Lissa Oak Red Blue Green Yellow Light Grey White

Minimum quantities and additional costs apply to premium colours - please ask for details



Best Selling Storage Units

- When ordering please specify:
 1. Tray colour required - see page 356 for colour options
 2. Carcass colour; Beech supplied as standard, please see previous page for carcass colour options
- **Please see Important Furniture Ordering Information on page 306 before placing your furniture order**

24 Tray Unit

- W1030 x D453 x H789mm

C213231*	24 Tray Unit - No Doors	£206.99
C213232*	24 Tray Unit - With Doors	£271.34

* Please specify carcass colour and tray colours



Gratnells trays
supplied free of
charge with all units
- see page 356 for
colours

30 Tray Unit

- W1030 x D453 x H961mm

C213241*	30 Tray Unit - No Doors	£285.78
C213242*	30 Tray Unit - With Doors	£352.70

* Please specify carcass colour and tray colours



Other Units (not shown)

C213251*	8 Tray Unit (Single Column) W360 x D453 x H789mm	£130.82
C213252*	16 Tray Unit (Double Column) W700 x D453 x H789mm	£185.00
C213253*	21 Tray Unit (Triple Column) W1030 x D453 x H703mm	£214.17

* Please specify carcass colour and tray colours

Tray & Shelving Units

C213261*	6 Tray Wide Unit & 2 Adjustable Shelves W1030 x D453 x H617mm	£185.00
C213262*	8 Tray Wide Unit & 2 Adjustable Shelves W1030 x D453 x H789mm	£197.34

* Please specify carcass colour and tray colours





Four Column Tray Units

- Great quality tray units
- Manufactured in the UK
- Gratnells trays supplied free of charge with all units - see page 356 for colour options
- **Please see Important Furniture Ordering Information on page 306 before placing your furniture order**
- When ordering please specify:
 1. Tray colour required - see page 356 for colour options
 2. Carcass colour please see following page for colour details



24 Shallow Tray Unit

- W1358 x D462 x H617mm

C213271*	24 Tray Unit - No Doors	£298.46
C213272*	24 Tray Unit - With Doors	£354.38

* Please specify carcass colour and tray colours



28 Shallow Tray Unit

- W1358 x D462 x H703mm

C213281*	28 Tray Unit - No Doors	£326.18
C213282*	28 Tray Unit - With Doors	£382.52

* Please specify carcass colour and tray colours



32 Shallow Tray Unit

- W1358 x D462 x H789mm

C213291*	32 Tray Unit - No Doors	£349.40
C213292*	32 Tray Unit - With Doors	£415.81

* Please specify carcass colour and tray colours

Other Units (not shown)

C213311*	20 Shallow Tray Unit - No Doors W1358 x D462 x H531mm	£273.49
C213312*	40 Shallow Tray Unit - No Doors W1358 x D462 x H961mm	£425.38
C213313*	48 Shallow Tray Unit - No Doors W1358 x D462 x H1133mm	£482.87
C213314*	64 Shallow Tray Unit - No Doors W1358 x D462 x H1477mm	£594.95

* Please specify carcass colour and tray colours



Tray Storage Cupboards

- Huge storage capacity in this popular range of tall storage units
- **Please see Important Furniture Ordering Information on page 306 before placing your furniture order**



21 Tray Unit with Doors

- Tray storage for 21 trays and 3 additional shelves
- Full height lockable doors
- W1030 x D477 x H1810mm

C213321* 21 Tray Cupboard - Full Doors £457.41

* Please specify carcass colour and tray colours



24 Tray Unit

- Tray storage for 24 trays and 2 additional shelves
- Half height or full height doors available
- W1030 x D485 x H1468mm

C213331* 24 Tray Cupboard - Half Doors £394.55

C213332* 24 Tray Cupboard - Full Doors £457.41

* Please specify carcass colour and tray colours

60 Tray Unit

- Available with or without doors
- W1030 x D477 x H1810mm

C213341* 60 Tray Cupboard - No Doors £504.72

C213342* 60 Tray Cupboard - Full Doors £581.95

* Please specify carcass colour and tray colours

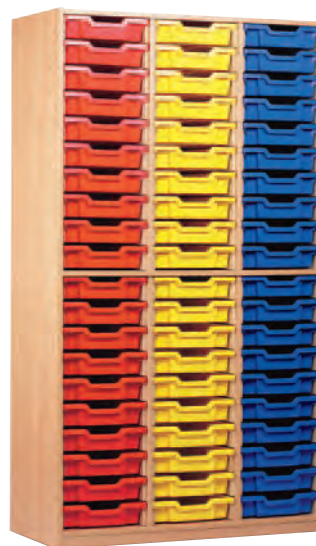

Please Specify:

1. Standard Carcass Colours - Beech or Maple
2. Tray colour required - see page 356 for colour options

Standard Carcass Colours



Beech *B Maple *M

Premium Carcass Colours



Lissa Oak Red Blue Green Yellow Light Grey White

Minimum quantities and additional costs apply to premium colours - please ask for details

Gratnells trays supplied free of charge with all units - see page 356 for colours



CALL US ON 01527 878348



VISIT WWW.FORWARDPRODUCTS.CO.UK



Jumbo Storage Units

- These units are extremely popular, offering organised storage capacity for large, messy and heavy items
- Gratnells trays supplied free of charge with all units, see page 356 for colour options
- **Please see Important Furniture Ordering Information on page 306 before placing your furniture order**
- When ordering please specify:
 1. Tray colour required - see page 356 for colour options
 2. Carcass colour please see following page for colour details

12 Jumbo Tray Unit

- W1358 x D453 x H1067mm

C213351*	12 Tray Unit - No Doors	£353.67
C213352*	12 Tray Unit - With Doors	£409.64

* Please specify carcass colour and tray colours

9 Jumbo Tray Unit

- W1030 x D453 x H1067mm

C213361*	9 Tray Unit - No Doors	£325.29
C213362*	9 Tray Unit - With Doors	£380.61

* Please specify carcass colour and tray colours

6 Jumbo Tray Unit

C213371*	6 Tall Tray Unit -No Doors	
	W700 x D453 x H1067mm	£254.33
C213372*	6 Tall Tray Unit -With Doors	
	W700 x D453 x H1067mm	£310.73
C213373*	6 Wide Tray Unit - No Doors	
	W1030 x D453 x H739mm	£347.26
C213374*	6 Wide Tray Unit - With Doors	
	W1030 x D453 x H739mm	£402.76

* Please specify carcass colour and tray colours

8 Jumbo Tray Unit

- W1358 x D453 x H739mm

C213381*	8 Tray Unit - No Doors	£278.82
C213382*	8 Tray Unit - With Doors	£334.08

* Please specify carcass colour and tray colours

4 Jumbo Tray Unit

- W700 x D453 x H810mm

C213391*	4 Tray Unit - No Doors	£244.22
C213392*	4 Tray Unit - With Doors	£290.37

* Please specify carcass colour and tray colours



Combination Storage Units

- Great storage possibilities with these variety units
- **Please see Important Furniture Ordering Information on page 306 before placing your furniture order**

Gratnells trays
supplied free of
charge with all units
- see page 356 for
colours



24 Shallow or 12 Deep Tray Unit

- The combination unit allows a mixture of shallow and deep trays
- W1358 x D453 x H707mm

C213411*	24/12 Tray Unit - No Doors	£314.74
C213412*	24/12 Tray Unit - With Doors	£367.01

* Please specify carcass colour and tray colours



32 Shallow or 16 Deep Tray Unit

- The combination unit allows a mixture of shallow and deep trays
- W1358 x D453 x H835mm

C213421*	32/16 Tray Unit - No Doors	£394.55
C213422*	32/16 Tray Unit - With Doors	£454.85

* Please specify carcass colour and tray colours



36 Shallow or 18 Deep Tray Unit

- This popular storage unit has a large capacity with 36 shallow or 18 deep trays, or a combination of both
- W1030 x D453 x H1210mm

C213431*	36/18 Tray Unit - No Doors	£414.91
C213432*	36/18 Tray Unit - With Doors	£485.86

* Please specify carcass colour and tray colours

Please Specify:

1. Standard Carcass Colours - Beech or Maple
2. Tray colour required - see page 356 for colour options

Standard Carcass
Colours



Beech *B Maple *M

Premium Carcass
Colours



Lissa Oak Red Blue Green Yellow Light Grey White

Minimum quantities and additional costs apply to premium colours - please ask for details



CALL US ON 01527 878348



VISIT WWW.FORWARDPRODUCTS.CO.UK



Extra Deep Storage Units

- Huge capacity with these popular extra deep tray units
- Gratnells trays supplied free of charge with all units, see page 356 for colour options
- **Please see Important Furniture Ordering Information on page 306 before placing your furniture order**

6 Extra Deep Tray Unit

- W700 x D453 x H857mm

C213441*	6 Tray Unit - No Doors	£208.77
C213442*	6 Tray Unit - With Doors	£264.63

* Please specify carcass colour and tray colours

12 Extra Deep Tray Unit

- W1358 x D453 x H857mm

C213451*	12 Tray Unit - No Doors	£353.85
C213452*	12 Tray Unit - With Doors	£411.91

* Please specify carcass colour and tray colours

16 Extra Deep Tray Unit

- W1358 x D453 x H1115mm

C213461*	16 Tray Unit - No Doors	£441.25
C213462*	16 Tray Unit - With Doors	£490.89

* Please specify carcass colour and tray colours

Gratnells trays
supplied free of
charge with all units
- see page 356 for
colours

Please Specify:

1. Standard Carcass Colours - Beech or Maple
2. Tray colour required - see page 356 for colour options

Standard Carcass Colours



Beech *B



Maple *M

Premium Carcass Colours



Lissa Oak



Red



Blue



Green



Yellow



Light Grey



White

Minimum quantities and additional costs apply to premium colours - please ask for details





Open & Sliding Door Tray Units

- Combination units with or without lockable sliding doors
- **Please see Important Furniture Ordering Information on page 306 before placing your furniture order**
- When ordering please specify:
 1. Tray colour required - see page 356 for colour options
 2. Carcass: please see previous page for colour details

16 Shallow, 4 Deep and 3 Extra Deep Tray Unit

C213471*	23 Tray Unit - No Doors	W1358 x D453 x H842mm	£382.76
C213472*	23 Tray Unit - With Sliding Doors	W1358 x D510 x H842mm	£450.06

* Please specify carcass colour and tray colours



8 Deep and 6 Extra Deep Tray Unit

C213481*	14 Tray Unit - No Doors	W1358 x D453 x H842mm	£376.78
C213482*	14 Tray Unit - With Sliding Doors	W1358 x D510 x H842mm	£447.54

* Please specify carcass colour and tray colours



16 Shallow and 6 Extra Deep Tray Unit

C213491*	22 Tray Unit - No Doors	W1358 x D453 x H842mm	£354.38
C213492*	22 Tray Unit - With Sliding Doors	W1358 x D510 x H842mm	£438.08

* Please specify carcass colour and tray colours





Open Bookcases

- This popular range of open bookcases has been specifically designed for classroom environments
- See below for colour options
- **Please see Important Furniture Ordering Information on page 306 before placing your furniture order**

A Bookcase 750

- 2 adjustable shelves
- W900 x D320 x H750mm

C213511* Bookcase 750mm £148.35

* Please specify carcass colour

B Bookcase 1000

- 2 adjustable shelves
- W900 x D320 x H1000mm

C213521* Bookcase 1000mm £162.84

* Please specify carcass colour

C Bookcase 1250

- 1 fixed and 2 adjustable shelves
- W900 x D320 x H1250mm

C213531* Bookcase 1250mm £177.14

* Please specify carcass colour

D Bookcase 1500

- 1 fixed and 2 adjustable shelves
- W900 x D320 x H1500mm

C213541* Bookcase 1500mm £208.22

* Please specify carcass colour

E Bookcase 1800

- 1 fixed and 4 adjustable shelves
- W900 x D320 x H1800mm

C213551* Bookcase 1800mm £232.13

* Please specify carcass colour

Please Specify:

1. Standard Carcass Colours - Beech or Maple

Standard Carcass Colours



Beech *B



Maple *M

Premium Carcass Colours



Lissa Oak



Red



Blue



Green



Yellow



Light Grey



White

Minimum quantities and additional costs apply to premium colours - please ask for details



Lockable Storage Cupboards

A Cupboard 750

- 2 adjustable shelves
- W1030 x D477 x H768mm

C213561* Cupboard 768mm £232.53

* Please specify carcass colour

B Cupboard 1000

- 2 adjustable shelves
- W1030 x D477 x H1018mm

C213571* Cupboard 1018mm £256.55

* Please specify carcass colour

C Cupboard 1250

- 1 fixed and 2 adjustable shelves
- W1030 x D477 x H1268mm

C213581* Cupboard 1268mm £284.78

* Please specify carcass colour

D Cupboard 1500

- 1 fixed and 2 adjustable shelves
- 1030 x D477 x H1518mm

C213591* Cupboard 1518mm £305.28

* Please specify carcass colour

E Cupboard 1800

- 1 fixed and 4 adjustable shelves
- W1030 x D477 x H1818mm

C213611* Cupboard 1818mm £332.19

* Please specify carcass colour



Please see Important Furniture Ordering Information on page 306 before placing your furniture order

Please Specify:

1. Standard Carcass Colours - Beech or Maple

Standard Carcass Colours



Beech *B Maple *M

Premium Carcass Colours



Lissa Oak Red Blue Green Yellow Light Grey White

Minimum quantities and additional costs apply to premium colours - please ask for details



CALL US ON 01527 878348



VISIT WWW.FORWARDPRODUCTS.CO.UK



Coloured Edge Storage Units

- Add some colour to the classroom with this bright innovative range
- Beech carcass supplied as standard, please see below for premium colour options
- Gratnells trays supplied free of charge with all units, see page 356 for colour options
- **Please see Important Furniture Ordering Information on page 306 before placing your furniture order**

Gratnells trays supplied free of charge with all units - see page 356 for colours

12 Jumbo Tray Unit

- W1358 x D453 x H1067mm

C213831	12 Tray Unit - With Red Edge	£378.39
C213832	12 Tray Unit - With Blue Edge	£378.39
C213833	12 Tray Unit - With Green Edge	£378.39

8 Jumbo Tray Unit

- W1358 x D453 x H739mm

C213841	8 Tray Unit - With Red Edge	£287.32
C213842	8 Tray Unit - With Blue Edge	£287.32
C213843	8 Tray Unit - With Green Edge	£287.32

24 Shallow Tray Unit

- W1030 x D453 x H789mm

C213851	24 Tray Unit - With Red Edge	£234.69
C213852	24 Tray Unit - With Blue Edge	£234.69
C213853	24 Tray Unit - With Green Edge	£234.69

18 Shallow Tray Unit

- W1030 x D453 x H617mm

C213861	18 Tray Unit - With Red Edge	£220.32
C213862	18 Tray Unit - With Blue Edge	£220.32
C213863	18 Tray Unit - With Green Edge	£220.32

Please Specify:

1. Standard Carcass Colour
2. Tray colour required - see page 356 for colour options

Standard Carcass Colour



Beech

Premium Carcass Colours



Lissa Oak



Red



Blue



Green



Yellow



Light Grey



White

*Minimum quantities and additional costs apply to premium colours - please ask for details



Coloured Edge Bookcases & Cupboards

- Durable bookcases and cupboards with brightly coloured edges
- 18mm carcass with heavy duty 25mm shelves
- When ordering please specify:
- Carcass colour; Beech supplied as standard, please see previous page for premium colour options
- **Please see Important Furniture Ordering Information on page 306 before placing your furniture order**



Low Storage Unit

- 2 adjustable shelves
- Cupboards with doors W1030 x D477 x H768mm
- Open bookcases W900 x D320 x H750mm

C213871	Cupboard - Red Edge	£237.69
C213872	Cupboard - Blue Edge	£237.69
C213873	Cupboard - Green Edge	£237.69

C213874	Bookcase - Red Edge	£150.16
C213875	Bookcase - Blue Edge	£150.16
C213876	Bookcase - Green Edge	£150.16



Medium Storage Unit

- 1 fixed and 2 adjustable shelves
- Cupboards with doors W1030 x D477 x H1268mm
- Open bookcases W900 x D320 x H1250mm

C213881	Cupboard - Red Edge	£280.80
C213882	Cupboard - Blue Edge	£280.80
C213883	Cupboard - Green Edge	£280.80

C213884	Bookcase - Red Edge	£159.20
C213885	Bookcase - Blue Edge	£159.20
C213886	Bookcase - Green Edge	£159.20



High Storage Unit

- 1 fixed and 4 adjustable shelves
- Cupboards with doors W1030 x D477 x H1818mm
- Open bookcases W900 x D320 x H1800mm

C213891	Cupboard - Red Edge	£337.67
C213892	Cupboard - Blue Edge	£337.67
C213893	Cupboard - Green Edge	£337.67

C213894	Bookcase - Red Edge	£182.61
C213895	Bookcase - Blue Edge	£182.61
C213896	Bookcase - Green Edge	£182.61





Perfect for stacking in primary and early years areas

Please Specify:

1. Standard Carcass Colours - Beech or Maple
2. Tray colour required - see page 356 for colour options

Standard Carcass Colours



Beech *B

Maple *M

Premium Carcass Colours



Lissa Oak

Red

Blue

Green

Yellow

Light Grey

White

Minimum quantities and additional costs apply to premium colours - please ask for details

Modular Storage Range

- These storage units are a versatile stackable storage solution that can be customised to suit every classroom
- Each unit comes complete with castors and locating pins which are used when stacking
- All units can be stacked with each other to make a whole range of different storage combinations
- Gratnells trays supplied free of charge with all units, see page 356 for colour options
- **Please see Important Furniture Ordering Information on page 306 before placing your furniture order**

Modular 24 Shallow Tray Unit

- W1030 x D450 x H745mm

C214121* 24 Shallow Tray Unit £238.23

* Please specify carcass colour and tray colours

Modular 12 Deep Tray Unit

- W1030 x D450 x H745mm

C214131* 12 Deep Tray Unit £248.88

* Please specify carcass colour and tray colours

Modular 6 Jumbo Tray Unit

- W1030 x D450 x H745mm

C214141* 6 Jumbo Tray Unit £243.68

* Please specify carcass colour and tray colours



Modular Storage Range

- Assortment of tray units and bookcase units
- When ordering please specify:
 1. Tray colour required - see page 356 for colour options
 2. Carcass colour: please see previous page for colour options
- **Please see Important Furniture Ordering Information on page 306 before placing your furniture order**



Modular 16 Shallow Tray Unit

- W692 x D450 x H745mm

C214151* 16 Shallow Tray Unit £236.49

* Please specify carcass colour and tray colours

Modular 8 Deep Tray Unit

- W692 x D450 x H745mm

C214161* 8 Deep Tray Unit £236.49

* Please specify carcass colour and tray colours



Gratnells trays supplied free of charge with all units - see page 356 for colours

Modular 4 Jumbo Tray Unit

- W692 x D450 x H745mm

C214171* 4 Jumbo Tray Unit £236.49

* Please specify carcass colour and tray colours

Modular Unit with 1 Shelf

- W692 x D450 x H745mm

C214181* Unit with 1 Shelf £209.74

* Please specify carcass colour



Modular Unit with 4 Compartments

- W692 x D450 x H745mm

C214191* Unit with 4 Compartments £209.74

* Please specify carcass colour



Examples of stacking configurations



CALL US ON 01527 878348



VISIT WWW.FORWARDPRODUCTS.CO.UK



Please Specify:

1. Standard Carcass Colours - Beech or Maple

Standard Carcass Colours



Beech *B



Maple *M

Premium Carcass Colours



Lissa Oak



Red



Blue



Green



Yellow



Light Grey



White

Minimum quantities and additional costs apply to premium colours - please ask for details

Art Storage Units

- Heavy duty units holding paper up to A1
- Huge storage potential, especially in the plan chests
- Bespoke and built-in plan chests also available, please call for details
- **Please see Important Furniture Ordering Information on page 306 before placing your furniture order**

Static Plan Chest

- 6 drawers with drawer stops
- Stylish silver D handles
- See below for colour options
- W1015 x D750 x H780mm

C214451	Static Plan Chest	£454.96
C214452	Plan Chest - Coloured Drawers	£461.01

* Please specify carcass colour

Mobile Paper Storage Unit

- 4 open fronted sliding drawers
- See below for colour options
- W1015 x D750 x H780mm

C214461	Mobile Storage Unit	£359.17
---------	---------------------	---------

* Please specify carcass colour

Mobile Paper Storage Unit with Doors

- 4 sliding drawers with lockable doors
- See below for colour options
- W1015 x D770 x H780mm

C214471	Mobile Storage Unit With Doors	£394.55
---------	--------------------------------	---------

* Please specify carcass colour



Art Storage Units

- Wide variety of additional units perfect for the storage of art materials
- Kinderbox units have deep, open top display compartments
- **Please see Important Furniture Ordering Information on page 306 before placing your furniture order**



16 Tray A3 Paper Storage Unit

- Trays available in Red, Yellow, Blue and Green
- W970 x D493 x H789mm

C214481* 16 Tray Storage Unit £305.28

* Please specify carcass colour and tray colours



Triple Combination Unit

- 12 shallow or 6 deep trays and 1 shelf
- W1030 x D453 x H789mm

C214491* Triple Combination Unit £256.55

* Please specify carcass colour and tray colours



Double Combination Unit

- 8 shallow or 4 deep trays and 1 shelf
- W700 x D453 x H789mm

C214511* Double Combination Unit £187.40

* Please specify carcass colour and tray colours



4 Bay Kinderbox Unit

- 8 shallow or 4 deep trays
- W690 x D453 x H600mm

C214521* 4 Bay Kinderbox £191.53

* Please specify carcass colour and tray colours



6 Bay Kinderbox Unit

- 12 shallow or 6 deep trays
- W1022 x D453 x H625mm

C214531* 6 Bay Kinderbox £275.71

* Please specify carcass colour and tray colours

Please Specify:

1. Standard Carcass Colours - Beech or Maple
2. Tray colour required - see page 356 for colour options

Standard Carcass Colours



Beech *B Maple *M

Premium Carcass Colours



Lissa Oak Red Blue Green Yellow Light Grey White

Minimum quantities and additional costs apply to premium colours - please ask for details



CALL US ON 01527 878348



VISIT WWW.FORWARDPRODUCTS.CO.UK



Maple Storage Range

- Exciting new storage range with a wide variety of complementary units
- Create stunning effects with coloured display panels and bright trays
- Maple carcass
- Gratnells trays supplied free of charge with all units, see below for colour options
- **Please see Important Furniture Ordering Information on page 306 before placing your furniture order**

A 6 Shallow Tray Unit

- W360 x D473 x H667mm

C214211 6 Shallow Tray Unit £139.45

* Please specify display panel colour & tray colours

B 12 Shallow Tray Unit

- W700 x D473 x H667mm

C214221 12 Shallow Tray Unit £215.58

* Please specify display panel colour & tray colours

C 18 Shallow Tray Unit

- W1030 x D473 x H667mm

C214231 18 Shallow Tray Unit £287.99

* Please specify display panel colour & tray colours

D 24 Shallow Tray Unit

- W1030 x D473 x H839mm

C214241 24 Shallow Tray Unit £360.41

* Please specify display panel colour & tray colours

Please Specify:

1. Panel colour
2. Tray colour

Carcass Colour



Maple

Display Panel Colour Options



Lime



Cyan



Tangerine



White

Tray Colour Options



Lime



Cyan



Tangerine



White



Clear



Maple Storage Range

- When ordering please specify:
 1. Tray colour required - see previous page for options
 2. Display panel colour - see previous page for options
- **Please see Important Furniture Ordering Information on page 306 before placing your furniture order**

A 8 Jumbo Tray Unit

- W1358 x D473 x H790mm

C214251	8 Jumbo Tray Unit	£327.95
---------	-------------------	---------

* Please specify display panel colour & tray colours



B 12 Jumbo Tray Unit

- W1358 x D473 x H1115mm

C214261	12 Jumbo Tray Unit	£469.17
---------	--------------------	---------

* Please specify display panel colour & tray colours



C 12 Variety Tray Unit

- W1358 x D473 x H752mm

C214271	12 Variety Tray Unit	£342.38
---------	----------------------	---------

* Please specify display panel colour & tray colours



D Angled Unit with 6 Deep Trays

- W1030 x D473 x H877mm

C214281	Angled Unit with 6 Deep Trays	£239.72
---------	-------------------------------	---------

* Please specify display panel colour & tray colours



E Double Sided Library Unit

- Double sided unit with 3 coloured angled shelves both sides
- W1040 x D502 x H883mm

C214291	Double Sided Library Unit	£221.90
---------	---------------------------	---------



F 12 Compartment Locker Unit

- Unit supplied with door colours as pictured
- W1358 x D493 x H1067mm

C214311	12 Compartment Locker Unit	£650.91
---------	----------------------------	---------





Maple Storage Range

- Extensive collection of units to complement the main Maple storage range
- **Please see Important Furniture Ordering Information on page 306 before placing your furniture order**

A Book Ladder

- W598 x D414 x H1245mm

C214331	Book Ladder	£221.90
---------	-------------	---------



B 6 Bay Kinderbox with Coloured Panels

C214341	Kinderbox - With Wheels W886 x D600 x H273mm	£158.10
C214342*	Kinderbox - With Legs W886 x D600 x H430mm	£158.10

* Please specify frame colour - see below



C 6 Bay Kinderbox Tray Unit

- 12 shallow or 6 deep trays
- W1022 x D473 x H600mm

C214351	6 Bay Kinderbox Tray Unit	£277.39
---------	---------------------------	---------



D 6 Bay Kinderbox Shelf Unit

- Brightly coloured inner panels and 1 fixed shelf each side
- W1015 x D450 x H820mm

C214361	6 Bay Kinderbox Shelf Unit	£244.71
---------	----------------------------	---------

Please Specify:

1. Panel colour
2. Tray colour

Carcass Colour



Maple

Display Panel & Leg Frame Colour Options



Lime



Cyan



Tangerine



White

Tray Colour Options



Lime



Cyan



Tangerine



White



Clear



Maple Storage Range

A Art Cupboard

- 16 trays and 7 shelves
- W1085 x D600 x H1503mm (when closed)

C214381 Art Cupboard £715.27

Please see Important Furniture Ordering Information on page 306 before placing your furniture order



A

B Dressing Up Cupboard

- 16 trays, 1 shelf, 2 hanging rails and mirror
- W1085 x D600 x H1503mm

C214391 Dressing Up Cupboard £798.90



B

C Book House with Trays

- Double-sided unit with coloured angled top
- W910 x D568 x H1011mm

C214371 3 Deep Trays & 1 Shelf £219.68
C214372 3 Deep & 2 Extra Deep Trays £228.07



C

D Book House with 7 Slots

- W910 x D568 x H1011mm

C214321 Book House with 7 Slots £244.11



D

Please Specify:

1. Panel colour
2. Tray colour

Carcass Colour



Maple

Display Panel Colour Options



Lime



Cyan



Tangerine



White

Tray Colour Options



Lime



Cyan



Tangerine



White



Clear



CALL US ON 01527 878348



VISIT WWW.FORWARDPRODUCTS.CO.UK

Tip:
Mix and match
top units and
base units to suit
your needs



Cloakroom Unit

- W1360 x D345 x H1325mm

C214411	Upright Bars	pk 2	£30.25
C214412	Top Unit with 8 Compartments		£244.11
C214413	Base Unit with 4 Deep Trays		£220.30

Maple Storage Range

- Please see Important Furniture Ordering Information on page 306 before placing your furniture order

When ordering please specify:

1. Frame colour (on cloakroom units only) - see below for options
2. Tray colour (if necessary) - see below for options
3. Top unit required (on cloakroom units only)
4. Base unit required (on cloakroom units only)
5. Every cloakroom unit must include upright bars, a top unit and a base unit



Cloakroom Unit

- W1360 x D345 x H1325mm

C214411	Upright Bars	pk 2	£30.25
C214414	Top Unit with Hanging Rail		£151.99
C214415	Base Unit with 8 Shallow Trays		£270.74



Cloakroom Unit

- W1360 x D345 x H1325mm

C214411	Upright Bars	pk 2	£30.25
C214416	Top Unit with 4 Compartments		£195.33
C214417	Base Unit with 4 Compartments		£195.33



Cloakroom Unit

- W1360 x D345 x H1325mm

C214411	Upright Bars	pk 2	£30.25
C214418	Top Unit with 8 Coat Hooks		£153.15
C214419	Base Unit with Rack		£290.77

Please Specify:

1. Frame colour
2. Tray colour

Carcass Colour



Maple

Frame Colour Options



Lime



Cyan



Tangerine



White

Tray Colour Options



Lime



Cyan



Tangerine



White



Clear



Static Metal Storage

- The same sturdy construction as the mobile metal storage units but with rubber feet instead of castors
- Supplied complete with light grey worktop
- When ordering please specify:
 1. Frame colour, see page 80 for options
 2. Tray colours, see page 356 for options
- **Please see Important Furniture Ordering Information on page 306 before placing your furniture order**



A Metal 8 Tray Unit

- W370 x D430 x H850mm

C214591 Metal 8 Tray Static Unit £198.10

* Please specify frame colour & tray colours



A



B

B Metal 16 Tray Unit

- W710 x D430 x H850mm

C214611 Metal 16 Tray Static Unit £207.81

* Please specify frame colour & tray colours



C



D

C Metal 24 Tray Unit

- W1050 x D430 x H850mm

C214621 Metal 24 Tray Static Unit £291.33

* Please specify frame colour & tray colours



E



F

D Metal 45 Tray Unit

- W1050 x D430 x H1510mm

C214631 Metal 45 Tray Static Unit £501.64

* Please specify frame colour & tray colours

E Metal 38 Tray Unit

- W710 x D430 x H1830mm

C214641 Metal 38 Tray Static Unit £403.97

* Please specify frame colour & tray colours

F Metal 57 Tray Unit

- W1050 x D430 x H1830mm

C214651 Metal 57 Tray Static Unit £539.93

* Please specify frame colour & tray colours

Gratnells trays
supplied free of
charge with all units
- see page 356 for
colours



Mobile Metal Storage

- Popular mobile storage units with durable steel frame and heavy duty castors
- Whilst often used in science labs, art rooms and tech areas because of the metal frame and solid worktop, these units are suitable for any area of the school
- Supplied complete with light grey worktop, trays and industrial castors
- **Please see Important Furniture Ordering Information on page 306 before placing your furniture order**

A Metal 6 Tray Unit

- W370 x D430 x H685mm

C214541	Metal 6 Tray Mobile Unit	£142.00
---------	--------------------------	---------

* Please specify frame colour & tray colours

B Metal 12 Tray Unit

- W710 x D430 x H685mm

C214551	Metal 12 Tray Mobile Unit	£210.31
---------	---------------------------	---------

* Please specify frame colour & tray colours

C Metal 18 Tray Unit

- W1050 x D430 x H685mm

C214561	Metal 18 Tray Mobile Unit	£270.74
---------	---------------------------	---------

* Please specify frame colour & tray colours

D Metal 24 Tray Unit

- W1050 x D430 x H855mm

C214571	Metal 24 Tray Mobile Unit	£360.14
---------	---------------------------	---------

* Please specify frame colour & tray colours

E Sports Trolley

- Perfect for storing PE equipment
- 6 jumbo trays
- W1050 x D430 x H1510mm

C214581	Sports Trolley	£419.51
---------	----------------	---------

* Please specify frame colour & tray colours

Please Specify:

1. Frame colour
2. Tray colour required - see page 356 for colour options

Frame Colour Options



Top Colour



Laptop Storage & Charging Units

Lapcabby - Horizontal

- 16 and 32 laptop trolley
- Stored on an individual sliding tray for improved accessibility
- Lockable unit to securely store and recharge laptops - sequential power supply included
- Rear facing doors allows easy access to the individual AC adapters supplied with laptops
- The Power7 timer allows schools to program which time each day they would prefer to charge their laptops according to the class schedule or Economy 7 to reduce energy bills
- An innovative cable storage system that keeps cables compact, neat and tidy

A. J214941	LapCabby 16 Horizontal W857 x D703 x H1215mm	£1440.54
B. J214942	LapCabby 32 Horizontal W1291 x D703 x H1215mm	£2147.49

* Please specify trim colour



When ordering please specify:
Trim colour required



A



B



Smooth rounded corners
for safety when moving



Please see Important Furniture Ordering Information on page 306 before placing your furniture order

Lapcabby - Vertical

- 10, 15 (includes projector and printer storage), 16 and 20 port laptop trolley
- Lockable unit to securely store and recharge laptops - sequential power supply included
- Specifically designed and tested air venting system maintains the security of the unit whilst increasing ventilation
- Soft rubber grips cushion and protect laptops when in storage and large L-shaped doors and sliding shelves provide easy, clear access to laptop storage compartment

C. J214931	LapCabby 10 Vertical W616 x D703 x H1115mm	£791.58
D. J214932	LapCabby 15 Vertical W1015 x D703 x H1115mm	£1184.03
E. J214933	LapCabby 16 Vertical W1015 x D703 x H1115mm	£983.29
F. J214934	LapCabby 20 Vertical W1015 x D703 x H1115mm	£1126.46

* Please specify trim colour



C



D



E



F



CALL US ON 01527 878348



VISIT WWW.FORWARDPRODUCTS.CO.UK



12

Early Years Furniture

Tables & Chairs	387-388
Themed Tables	389
Storage	390
Soft Seating	391-394



Beech Tables

- High quality long lasting tables
- Durable laminated tops with solid beech frame
- Meets EN1729 Part 1 primary height regulations
- Rounded bullnosed edged tops for extra durability and added safety
- Quick and easy installation, please call if you require cost for installation
- **Please see Important Furniture Ordering Information on page 306 before placing your furniture order**

Top Colour Options



Beech

Blue

Rectangular Tables

- 1100 x 550mm, three height options
- Option for Beech or Blue tops

E211121	Beech Table H530mm	£132.99
E211122	Beech Table H590mm	£132.99
E211123	Beech Table H640mm	£132.99

E211124	Blue Table H530mm	£132.99
E211125	Blue Table H590mm	£132.99
E211126	Blue Table H640mm	£132.99



Trapezoidal Tables

- 1100 x 550mm, three height options
- Option for Beech or Blue tops

E211131	Beech Table H530mm	£132.99
E211132	Beech Table H590mm	£132.99
E211133	Beech Table H640mm	£132.99

E211134	Blue Table H530mm	£132.99
E211135	Blue Table H590mm	£132.99
E211136	Blue Table H640mm	£132.99



Beech Chairs

- Popular solid hardwood chair with either coloured seats and backs or a Beech finish
- The chairs are stackable and are available in three heights
- Supplied in packs of 2, please call for a price if you require less than pack of 2

E211141	Beech Chair H310mm	pk 2	£80.11
E211142	Beech Chair H350mm	pk 2	£82.14
E211143	Beech Chair H380mm	pk 2	£84.39

E211144	Blue Chair H310mm	pk 2	£80.11
E211145	Blue Chair H350mm	pk 2	£82.14
E211146	Blue Chair H380mm	pk 2	£84.39

Chair Colour Options



Please see Important Furniture Ordering Information on page 306 before placing your furniture order



Rectangular Height Adjustable Table

- Premium quality table with sturdy 25mm laminated tops
- Durable moulded PVC edges
- Self levelling feet, perfect for uneven floors
- Powder coated scratch resistant black frames
- Size: W1500 x D750mm
- Adjustable height in 25mm increments: nominal 430-635mm

E211151	Rectangular Table, Red	£193.88
E211152	Rectangular Table, Blue	£193.88

Table Colour Options



Teachers Flower Height Adjustable Table

- The same high quality 25mm laminated tops, moulded PVC edges and self levelling feet as the rectangular tables
- Size: 1525mm diameter
- Adjustable height in 25mm increments: nominal 430-635mm

E211161	Teachers Flower Table, Red	£284.40
E211162	Teachers Flower Table, Blue	£284.40



CALL US ON 01527 878348



VISIT WWW.FORWARDPRODUCTS.CO.UK



Themed Tables

- Premium quality height adjustable tables perfect for group work, these theme tables are very popular in primary schools, special schools and nurseries
- Sturdy 25mm laminated tops with moulded black PVC edges
- Self levelling feet, perfect for uneven floors
- Scratch resistant black powder coated frames
- Quick and easy installation, please call if you require cost for installation
- **Please see Important Furniture Ordering Information on page 306 before placing your furniture order**

Table Colour Options



Great for early years group work



Horseshoe Table

- The horseshoe table is one of the largest of our themed tables
- Top size 1520 x 1442mm
- Height adjustable from 430 - 635mm

E211171	Red Horseshoe	£294.74
E211172	Blue Horseshoe	£294.74
E211173	Yellow Horseshoe	£294.74



Clover Table

- This table has a top shape designed for group work and interaction
- Top size is 1200 x 1200mm
- Height adjustable from 430 - 635mm

E211191	Red Clover Table	£158.71
E211192	Blue Clover Table	£158.71



Arc Table

- This table, like the horseshoe shape is specially developed for work with teachers
- Top size 750 x 1500mm
- Height adjustable from 430 - 635mm

E211181	Red Arc Table	£191.29
E211182	Blue Arc Table	£191.29
E211183	Yellow Arc Table	£191.29



Flower Table

- This table has a top shape designed for group work like the Clover table but a bit larger for 6+ students
- Top size 1525 x 1525mm
- Height adjustable from 430 - 635mm

E211211	Red Flower Table	£249.35
E211212	Blue Flower Table	£249.35
E211213	Yellow Flower Table	£249.35





9 Bin Tilt Storage

- Complete with strong lockable castors
- Each pack includes 9 colourful storage bins, each one with a clear plastic lid
- Manufactured from strengthened tubular plastic (flat packed)
- Bin Dimensions: H140mm x W230mm x L360mm
- Size (assembled): H838 x W838 x D381mm

E211214	Tilt Storage Unit	£151.50
---------	-------------------	---------



18 Bin Mobile Storage

- Complete with strong lockable castors
- Each pack includes 18 colourful storage bins, each one with a clear plastic lid
- Manufactured from strengthened tubular plastic (flat packed)
- Bin Dimensions: H140mm x W230mm x L360mm
- Size (assembled): H838 x W838 x D838mm

E211215	Mobile Storage Unit	£300.74
---------	---------------------	---------

Please see Important Furniture Ordering Information on page 306 before placing your furniture order



3 Shelf Maple Bookcase

- Manufactured from 15mm MDF (flat packed)
- At assembly, shelves can be adjusted every 96mm
- Size (assembled): H725 x W900 x D300mm

E211216	Maple Bookcase	£186.84
---------	----------------	---------

3 Shelf Primary Coloured Bookcase

E211217	Coloured Bookcase	£186.84
---------	-------------------	---------



Big Book Holder – Maple

- Manufactured from 15mm MDF (flat packed)
- 4 separate compartments for storing up to 50 Big Books, each compartment measures 107mm width
- Supplied complete with plastic feet
- Size (assembled): H555 x W510 x D420mm

E211218	Maple Big Book Holder	£166.89
---------	-----------------------	---------

Big Book Holder Primary Coloured

E211219	Coloured Big Book Holder	£166.89
---------	--------------------------	---------



CALL US ON 01527 878348



VISIT WWW.FORWARDPRODUCTS.CO.UK

 Now available in anti-microbial woven fabric, effective against Covid-19 see page 565

Allsorts Seating

- Join our Allsorts range together for a complete chair, sofa and table set
- The top is set within an upholstered lip for safety
- Popular colour options below, please see further fabric and vinyl options on pages 561-568



Allsorts Modular Chair

- W440 x D470 x SH350 / Overall Height 600mm

E211472 £227.12

* Please specify colour required

Allsorts Modular Sofa

- W880 x D470 x SH350 / Overall Height 600mm

E211473 £287.24

* Please specify colour required

Please see Important Furniture Ordering Information on page 3 before placing your furniture order



Allsorts Modular Beech Top Table

- W470 x D470 x H350mm

E211474 £262.19

* Please specify colour required

Popular Colour Options
Main Line Plus Fabric

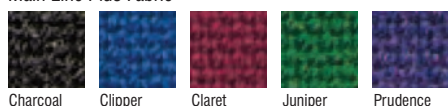

Anti-microbial Just Colour Vinyl (add 15% to prices)

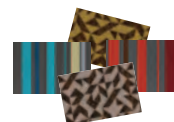

See pages 561-568 for further fabric options



Notes Seating

- Hardwearing seating range perfect for infant breakout and reading areas
- Fun design available in range of bright faux leather finishes
- One, two and three seater options
- Popular colour options shown on previous page, please see further fabric and vinyl options on pages 561-568
- **Please see Important Furniture Ordering Information on page 3 before placing your furniture order**



Single Seater

- Overall height 600mm
- W400 x D450 x SH360mm
- Popular colour options shown on previous page, please see further fabric and vinyl options on pages 561-568

E211414	Single Seater - Single Colour	£237.01
E211415	Single Seater - Two Tone	£237.01

* Please specify colour required

Mix & Match Colours to Produce Stunning Effects

Now available in anti-microbial woven fabric, effective against Covid-19 see page 565



Two Seater

- Overall height 600mm
- W820 x D450 x SH360mm
- Popular colour options shown on previous page, please see further fabric and vinyl options on pages 561-568

E211416	2 Seater - Single Colour	£304.84
E211417	2 Seater - Two Tone	£304.84

* Please specify colour required



Three Seater

- Overall height 600mm
- W1300 x D450 x SH360mm
- Popular colour options shown on previous page, please see further fabric and vinyl options on pages 561-568

E211418	3 Seater - Single Colour	£347.93
E211419	3 Seater - Two Tone	£347.93

* Please specify colour required

Tech2 Cloakroom Trolley

- 12 double coat/bag hooks each side to store 24 coats
- Perspex name card-holders for easy location and identification hooks
- Large base stand for shoes & bags etc. with a centre divide & lip for holding items (shelf depth each side 260mm)
- Label holder on end panel to identify name/class/year
- Reinforced powder coated (EPC) scratch resist and tubular frame structure gives superior strength
- Tested to BS58873 strength and stability standards
- Supplied flat packed for simple self assembly
- Size: W1300 x D740 x H1220mm

E211541	Cloakroom Trolley	each	£356.67
---------	-------------------	------	---------



CALL US ON 01527 878348



VISIT WWW.FORWARDPRODUCTS.CO.UK



+ Now available in anti-microbial woven fabric, effective against Covid-19 see page 565

Please see Important Furniture Ordering Information on page 3 before placing your furniture order

Versatile Seat Pods

- Colourful and fun these seat pods are great for reading corners and libraries
- Wipe clean finish also suitable for outdoor use
- Size: H200 x D380mm
- Assorted pack contains one each of Red, Blue, Green, Purple and Grey

E211236	Assorted	pk 5	£136.62
---------	----------	------	---------

Multicoloured Bean Bag

- Bring reading corners to life with these vibrant bean bags
- Waterproof and wipe clean
- Size: H750 x D640mm
- Bright orange, green and blue finish

E211341	Multicoloured Bean Bag		£75.35
---------	------------------------	--	--------

Kaleido Seating

- An armchair and sofa just the right size for children to get comfortable on
- Tough enough for group environments but stylish enough to have at home
- These chairs look particularly striking when the arms and seats are finished in different colours
- Popular colour options below, please see further fabric and vinyl options on pages 561-568



Kaleido 2 Seater Sofa

- Overall: W900 x D540 x H560mm
Seat: W780 x D380 x H320mm
Arm height: 445mm

E211311	2 Seater - Single Colour	each	£335.67
E211312	2 Seater - Two Tone	each	£354.04

* Please specify colour required

Kaleido Armchair

- Overall: W600 x D540 x H560mm
Seat: W380 x D380 x H320mm
Arm height: 445mm

E211321	Armchair - Single Colour	each	£297.26
E211322	Armchair - Two Tone	each	£312.29

* Please specify colour required

Popular Colour Options

Main Line Plus Fabric

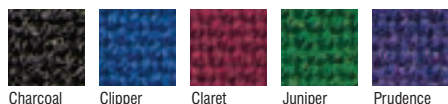

Anti-microbial Just Colour Vinyl (add 15% to prices)

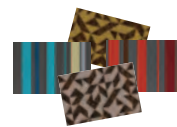

See pages 561-568 for further fabric options





Segment Soft Seating

- Tough enough to take rough and tumble treatment, yet light enough for children to move around
- Mix colour schemes and other items from our range to create your own personal seating environment
- Popular colour options shown on previous page, please see further fabric and vinyl options on pages 561-568
- **Please see Important Furniture Ordering Information on page 3 before placing your furniture order**

 Now available in anti-microbial woven fabric, effective against Covid-19 see page 565

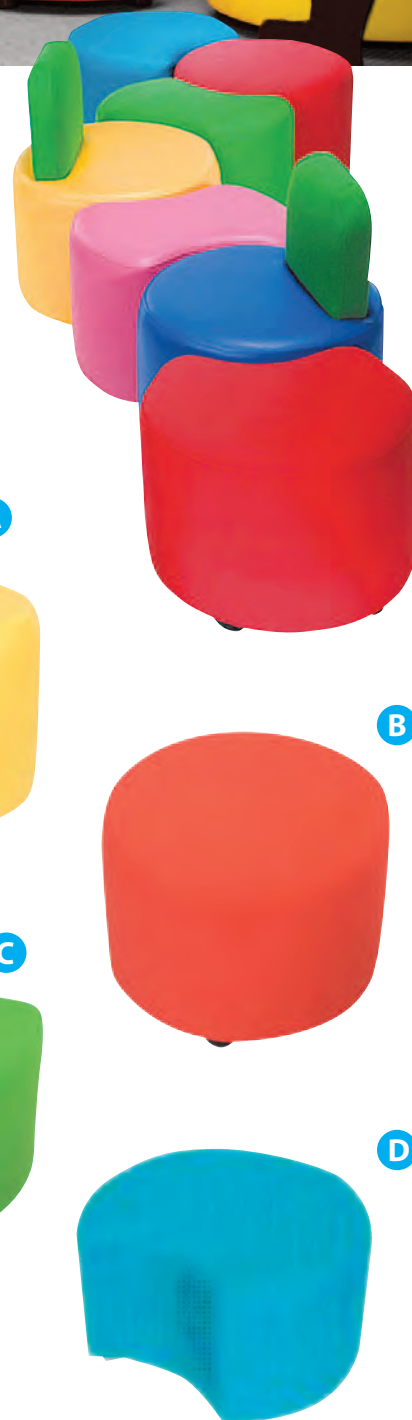

A Segment Circular Chair

- Overall height 510mm
W400 x D400 x H300mm

E211351	Circular Chair - Single Colour	each	£125.25
E211352	Circular Chair - Two Tone	each	£130.26

* Please specify colour required

B Segment Circular Pouffe

- W400 x D400 x H300mm

E211361	Circular Pouffe	each	£111.89
---------	-----------------	------	---------

* Please specify colour required

C Segment Dogbone Pouffe

- W310 x D400 x H300mm

E211371	Segment Pouffe	each	£111.89
---------	----------------	------	---------

* Please specify colour required

D Segment Curved Pouffe

- W350 x D400 x H300mm

E211381	Curved Pouffe	each	£111.89
---------	---------------	------	---------

* Please specify colour required



CALL US ON 01527 878348



VISIT WWW.FORWARDPRODUCTS.CO.UK



13

Healthcare

Covid Testing Pods	397
Floor Standing Screens	398
Testing Booths	399-400
Free-standing Desktop Screens	401-402



Swab procedure posters and sanitary equipment illustrated in the document not supplied.

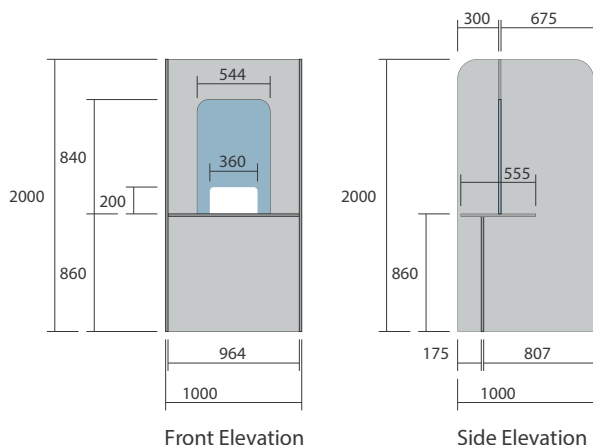
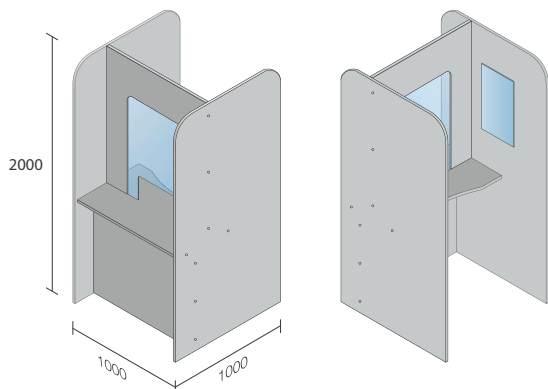

A. COVID Testing Pods - Grey

- Our Freestanding COVID Testing Pods provide a discreet and efficient area for staff and students and are designed to achieve a comfortable area while performing RNA tests
- Made from heavy duty MFC, they are both sturdy, practical and aesthetically pleasing, quick to install and can be easily moved around in your testing area as requirements evolve
- The acrylic safety screen has a cut out slot 200mm high x 360mm wide, which is large enough to post a test tube through inside a holder
- Mirror included for a participant to observe their RNA swab procedure
- 1000 x 1000 x H2000mm

	1-4	5-9	10+
CP1001	£577.23	£548.49	£498.49

- COVID testing pod as above but with heavy duty lockable castors
- Enables easy moving for greater flexibility

CP1011	Testing Pod with Locking Castors	£672.23
--------	----------------------------------	---------



A. Retractable Barrier Black Frame/Black Belt

- Ideal for channelling queues
- 2.5m long and connects into position with a 4-way safety button
- For indoor use
- £25 delivery charge

RB25 each £34.29



B. Mobile Medical Floor Standing Privacy Screen - White

- Free-standing mobile privacy screen
- Additional screens can be linked via a linking hinge
- Supplied with two individual locking castors
- Steel frame surrounds and leg supports MDF screen providing an acoustic barrier
- Screens can be nested when not in use to save space
- 100% recyclable and easily cleaned
- W1000 x H1900mm

MFSPS £246.15



C. Opaque Health Screen

- Our opaque healthcare screens are easy to assemble, hygienic and low maintenance making them ideal for COVID testing areas
- The top and bottom panels are made from easy clean opaque Akare material
- The sturdy steel frame and H base plates are powder-coated in matt black
- Supplied as a flat pack – 20 mins assembly time
- Black steel frame

SCR750	H1850 x W750mm	each	£199.00
SCR1500	H1850 x W1500mm	each	£279.00



CALL US ON 01527 878348



VISIT WWW.FORWARDPRODUCTS.CO.UK



A. Singular Covid Testing Booth

- Create a safe and user friendly Covid testing area with our freestanding, modular COVID Testing Booths
- DDA Compliant design
- Choose from standalone or linking add-on modules – with two different size options for greater flexibility and DDA wheelchair access
- The simplicity of add-on modules allows them to be quickly assembled or disassembled when not required
- Supplied with a mirror, built in table top, and an acrylic safety screen with a 200mm high x 360mm wide cut out slot which is large enough to post a completed Covid test through inside a holder
- The booths streamline the whole Covid testing process, helping to cut down the time spent on each test and to improve safety
- Made from heavy duty MFC in a durable white finish, the booths are sturdy, practical and aesthetically pleasing and can be repeatedly sanitised using sprays, wipes or fogging machines
- Delivery within 2-3 weeks of ordering to mainland UK - call for a quote on installation, or for deliveries outside of mainland UK



CP2001

CP2002



CP2003

CP2004

Starter Module

CP2001	W1250 x D2425 x H2000mm	£761.85
--------	-------------------------	---------

Add-on Module

CP2002	W1250 x D2425 x H2000mm	£684.92
--------	-------------------------	---------

B. Fully Accessible Covid Testing Booth

Starter Module

CP2003	W2475 x D2450 x H2000mm	£992.62
--------	-------------------------	---------

Add-on Module

CP2004	W2450 x D2450 x H2000mm	£915.69
--------	-------------------------	---------



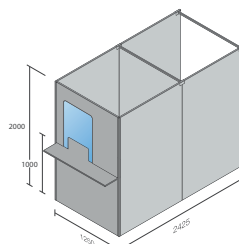
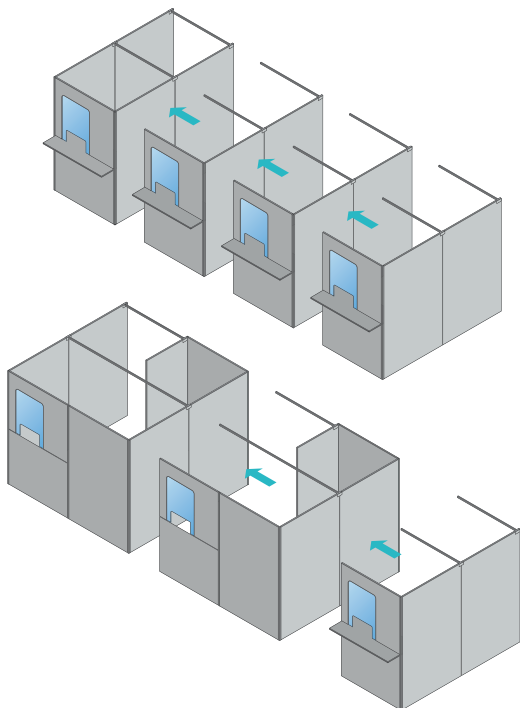

Singular Master Booth

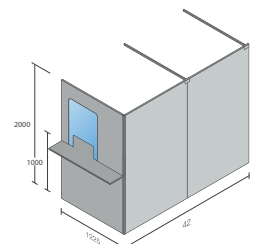

Singular Intermediate Booth

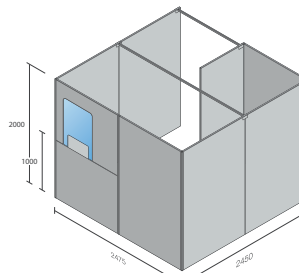

Singular Fully Accessible Master Booth

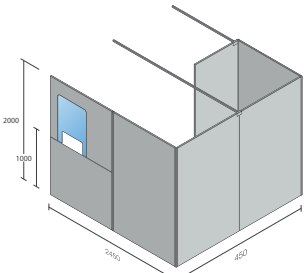

Singular Intermediate Fully Accessible Booth



CALL US ON 01527 878348



VISIT WWW.FORWARDPRODUCTS.CO.UK

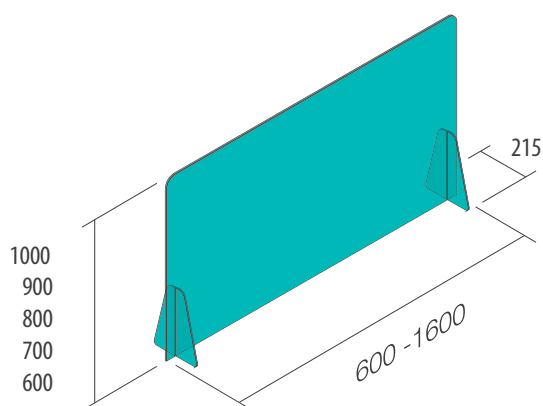
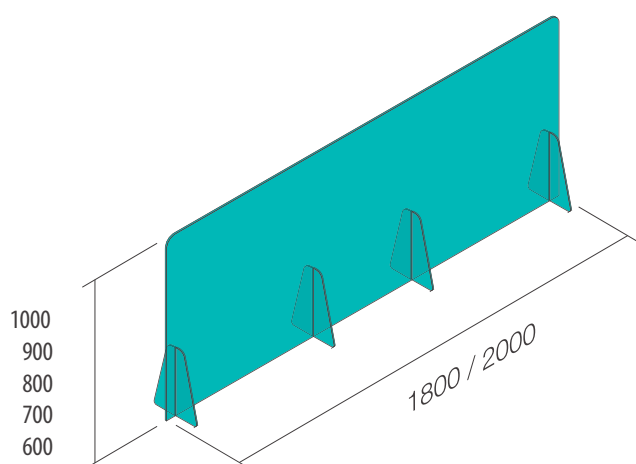

600mm, 700mm, 800mm, 900mm, 1000mm, 1200mm, 1400mm and 1600mm Wide Screens.

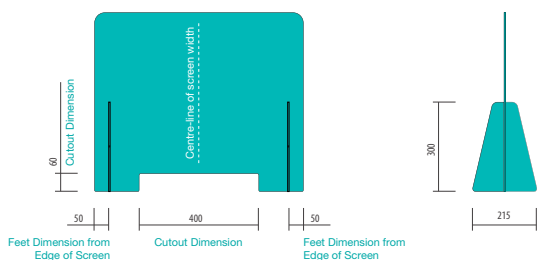

Desktop Safeguard Acrylic Screen Without Cutouts

- Free-standing screen - no fixings required
- Clear 5mm acrylic panel and support feet
- Easily assembled and disassembled
- Airborne pathogen barrier between individual people
- Can be moved freely
- No porous materials used - surfaces easily cleaned

A. 1800 & 2000mm Wide Without Cutout

- Single acrylic screen with 4 upstands

	Size W x D x H(mm)	1-10	11-25	26+
CP3001	1800 x 5 x 1000	£222.44	£200.00	£192.50
CP3002	1800 x 5 x 900	£200.40	£180.00	£171.88
CP3003	2000 x 5 x 800	£197.06	£178.13	£170.63
CP3004	1800 x 5 x 800	£179.02	£159.38	£153.13
CP3005	2000 x 5 x 700	£173.68	£155.00	£148.75
CP3006	1800 x 5 x 700	£169.62	£140.63	£134.38
CP3007	2000 x 5 x 600	£162.34	£133.13	£128.13
CP3008	1800 x 5 x 600	£145.60	£120.63	£115.63

B. 600 - 1600mm Wide Without Cutout

- Single acrylic screen with 2 upstands

	Size W x D x H(mm)	1-10	11-25	26+
CP3009	1600 x 5 x 1000	£197.06	£178.13	£170.63
CP3010	1400 x 5 x 1000	£173.68	£155.00	£148.75
CP3011	1200 x 5 x 1000	£148.96	£133.13	£128.13
CP3012	1000 x 5 x 1000	£123.58	£111.25	£106.25
CP3013	900 x 5 x 1000	£118.90	£106.25	£101.88
CP3014	800 x 5 x 1000	£115.02	£95.63	£90.63
CP3015	700 x 5 x 1000	£100.46	£83.13	£80.00
CP3016	600 x 5 x 1000	£85.90	£71.88	£68.75

CP3017	1600 x 5 x 900	£179.02	£159.38	£153.13
CP3018	1400 x 5 x 900	£155.64	£140.63	£134.38
CP3019	1200 x 5 x 900	£133.60	£120.63	£115.63
CP3020	1000 x 5 x 900	£112.22	£100.00	£95.63
CP3021	900 x 5 x 900	£106.88	£95.63	£92.50
CP3022	800 x 5 x 900	£104.10	£86.25	£81.25
CP3023	700 x 5 x 900	£91.00	£75.00	£71.88
CP3024	600 x 5 x 900	£86.40	£64.38	£61.25

CP3025	1600 x 5 x 800	£158.98	£142.50	£136.25
CP3026	1400 x 5 x 800	£138.94	£125.00	£118.75
CP3027	1200 x 5 x 800	£118.90	£106.25	£101.88
CP3028	1000 x 5 x 800	£98.86	£89.38	£84.38
CP3029	900 x 5 x 800	£95.52	£86.25	£81.25
CP3030	800 x 5 x 800	£93.18	£76.88	£73.75
CP3031	700 x 5 x 800	£80.08	£65.63	£64.38
CP3032	600 x 5 x 800	£76.00	£56.25	£55.00

CP3033	1600 x 5 x 700	£138.94	£125.00	£118.75
CP3034	1400 x 5 x 700	£122.24	£109.38	£105.00
CP3035	1200 x 5 x 700	£103.54	£93.75	£89.38
CP3036	1000 x 5 x 700	£86.84	£78.13	£75.00
CP3037	900 x 5 x 700	£83.50	£75.00	£71.88
CP3038	800 x 5 x 700	£80.08	£65.63	£64.38
CP3039	700 x 5 x 700	£71.34	£58.13	£56.25
CP3040	600 x 5 x 700	£66.40	£50.00	£48.75

CP3041	1600 x 5 x 600	£118.90	£106.25	£101.88
CP3042	1400 x 5 x 600	£103.54	£93.75	£89.38
CP3043	1200 x 5 x 600	£88.84	£80.00	£76.88
CP3044	1000 x 5 x 600	£73.48	£67.50	£64.38
CP3045	900 x 5 x 600	£72.14	£64.38	£61.25
CP3046	800 x 5 x 600	£69.16	£56.25	£55.00
CP3047	700 x 5 x 600	£66.40	£50.00	£48.75
CP3048	600 x 5 x 600	£56.00	£42.50	£40.63



Desktop Safeguard Acrylic Screen With Cutouts

- Free-standing screen - no fixings required
- Clear 5mm acrylic panel and support feet
- Easily assembled and disassembled
- Airborne pathogen barrier between individual people
- Can be moved freely
- No porous materials used - surfaces easily cleaned

A. 1800 & 2000mm Wide With Cutout

- Single acrylic screen with 4 upstands

	Size W x D x H(mm)	1-10	11-25	26+
CP3049	1800 x 5 x 1000	£222.44	£200.00	£192.50
CP3050	1800 x 5 x 900	£200.40	£180.00	£171.88
CP3051	2000 x 5 x 800	£197.06	£178.13	£170.63
CP3052	1800 x 5 x 800	£179.02	£159.38	£153.13
CP3053	2000 x 5 x 700	£173.68	£155.00	£148.75
CP3054	1800 x 5 x 700	£169.62	£140.63	£134.38
CP3055	2000 x 5 x 600	£162.34	£133.13	£128.13
CP3056	1800 x 5 x 600	£160.00	£120.63	£115.63

B. 600 - 1600mm Wide With Cutout

- Single acrylic screen with 2 upstands

	Size W x D x H(mm)	1-10	11-25	26+
CP3057	1600 x 5 x 1000	£197.06	£178.13	£170.63
CP3058	1400 x 5 x 1000	£173.68	£155.00	£148.75
CP3059	1200 x 5 x 1000	£148.96	£139.38	£128.13
CP3060	1000 x 5 x 1000	£123.58	£133.13	£106.25
CP3061	900 x 5 x 1000	£118.90	£106.25	£101.88
CP3062	800 x 5 x 1000	£115.02	£95.63	£90.63
CP3063	700 x 5 x 1000	£100.46	£83.13	£80.00
CP3064	600 x 5 x 1000	£94.40	£71.88	£68.75

CP3065	1600 x 5 x 900	£179.02	£159.38	£153.13
CP3066	1400 x 5 x 900	£155.64	£140.63	£134.38
CP3067	1200 x 5 x 900	£133.60	£120.63	£115.63
CP3068	1000 x 5 x 900	£112.22	£100.00	£95.63
CP3069	900 x 5 x 900	£106.88	£95.63	£92.50
CP3070	800 x 5 x 900	£104.10	£86.25	£81.25
CP3071	700 x 5 x 900	£91.00	£75.00	£71.88
CP3072	600 x 5 x 900	£86.40	£64.38	£61.25

CP3073	1600 x 5 x 800	£158.98	£142.50	£136.25
CP3074	1400 x 5 x 800	£138.94	£125.00	£118.75
CP3075	1200 x 5 x 800	£118.90	£106.25	£101.88
CP3076	1000 x 5 x 800	£98.86	£89.38	£84.38
CP3077	900 x 5 x 800	£95.52	£86.25	£81.25
CP3078	800 x 5 x 800	£93.18	£76.88	£73.75
CP3079	700 x 5 x 800	£80.08	£65.63	£64.38
CP3080	600 x 5 x 800	£76.00	£56.25	£55.00

CP3081	1600 x 5 x 700	£138.94	£125.00	£118.75
CP3082	1400 x 5 x 700	£122.24	£109.38	£105.00
CP3083	1200 x 5 x 700	£103.54	£93.75	£89.38
CP3084	1000 x 5 x 700	£86.84	£78.13	£75.00
CP3085	900 x 5 x 700	£83.50	£75.00	£71.88
CP3086	800 x 5 x 700	£80.08	£65.63	£64.38
CP3087	700 x 5 x 700	£71.34	£58.13	£56.25
CP3088	600 x 5 x 700	£66.40	£50.00	£48.75

CP3089	1600 x 5 x 600	£118.90	£106.25	£101.88
CP3090	1400 x 5 x 600	£103.54	£93.75	£89.38
CP3091	1200 x 5 x 600	£88.84	£80.00	£76.88
CP3092	1000 x 5 x 600	£73.48	£67.50	£64.38
CP3093	900 x 5 x 600	£72.14	£64.38	£61.25
CP3094	800 x 5 x 600	£69.16	£56.25	£55.00
CP3095	700 x 5 x 600	£66.40	£50.00	£48.75
CP3096	600 x 5 x 600	£56.00	£42.50	£40.63

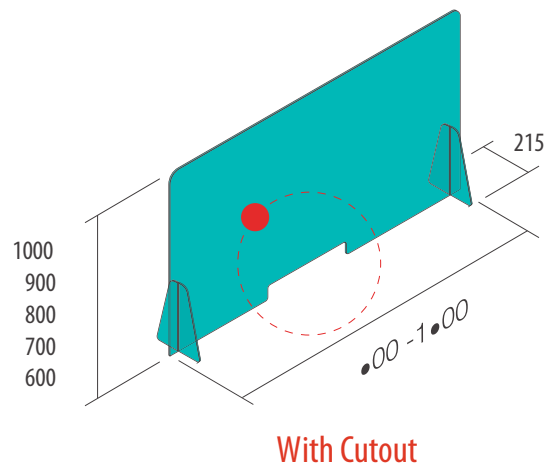
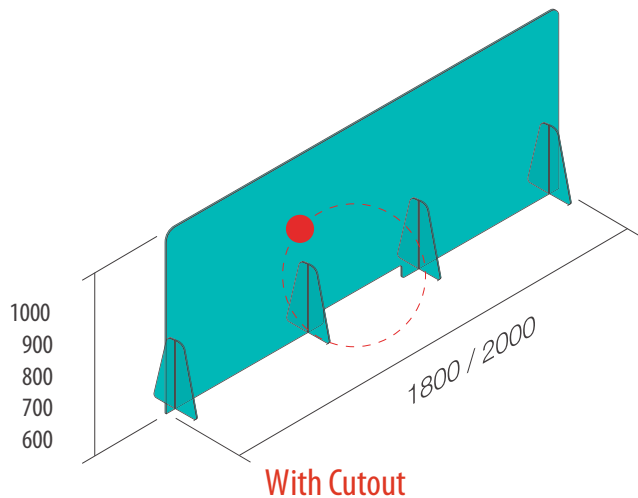

1800mm and 2000mm Wide Screens.

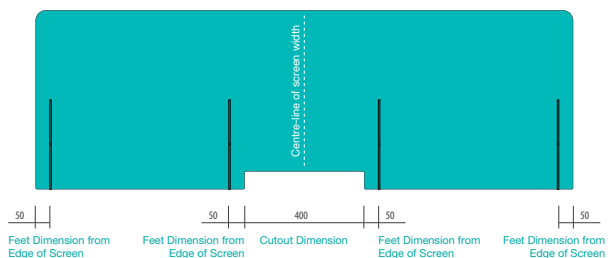



14

Office Accessories

Whiteboards	405-408
Drywipe Easels	409-410
Revolving Boards	411
Reading & Writing Centre	412
Noticeboards	413-419
Snap Display Frames	419
Display Panel Kits	420
Clocks	421
Key & First Aid Cabinets	422
Plants	423-424



A



Non-returnable items, please report damages or discrepancies within 72 hours

B



C

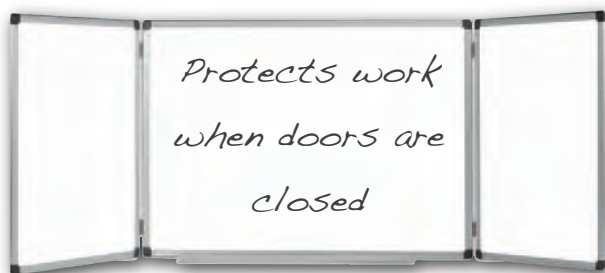

A Non-Magnetic Whiteboards

- This plain double sided whiteboard has a revolutionary new surface which is ultra smooth on both sides improving erasability and reducing ghosting
- Aluminium framed plain white surface, supplied with concealed wall fixings and pen tray
- All boards 1800mm wide and larger have extra central fixings at top and bottom for additional safety and stability

SMDW32	600 x 900mm	each	£22.14
SMDW43	900 x 1200mm	each	£32.09
SMDW44	1200 x 1200mm	each	£42.79
SMDW54	1500 x 1200mm	each	£54.56
SMDW64	1800 x 1200mm	each	£59.72
SMDW84	2400 x 1200mm	each	£74.87
SMDW88	2700 x 1200mm	each	£138.83

B Magnetic Whiteboards

- This economically priced whiteboard has a revolutionary new surface which is ultra smooth to improve erasability, with the added advantage of accepting magnets
- Aluminium framed plain white drywipe surface
- Supplied with concealed wall fixings and pen tray
- All boards 1800mm wide and larger have extra central fixings at top and bottom for additional safety and stability

SMDWM32	600 x 900mm	each	£33.77
SMDWM43	900 x 1200mm	each	£50.30
SMDWM44	1200 x 1200mm	each	£61.58
SMDWM54	1500 x 1200mm	each	£71.50
SMDWM64	1800 x 1200mm	each	£83.76
SMDWM84	2400 x 1200mm	each	£104.97
SMDWM88	2700 x 1200mm	each	£139.61

C Trio Whiteboards

- Unique design creates multifunctional ability
- Three separate magnetic whiteboard surfaces when open
- Aluminium framed with fixings and pen tray
- Sizes refer to central board

TR1010	900 x 600mm	each	£96.04
TR2020	1200 x 900mm	each	£154.84



A Vitreous Enamel Steel Magnetic Whiteboard

- Vitreous Enamel Steel - the ultimate in dry-wipe surfaces is guaranteed for 25 years - invest in the best
- Aluminium framed whiteboards with concealed corner fixings and pen tray
- Surface can be used with all brands of drywipe markers and also accept magnets
- All boards 1800mm wide and larger have extra central fixings at top and bottom for additional safety and stability

VDW32	900 x 600mm	each	£48.52
VDW43	1200 x 900mm	each	£69.97
VDW44	1200 x 1200mm	each	£95.74
VDW54	1500 x 1200mm	each	£120.17
VDW64	1800 x 1200mm	each	£140.64
VDW84	2400 x 1200mm	each	£179.39
VDW88	2700 x 1200mm	each	£229.55

25 YEAR WARRANTY

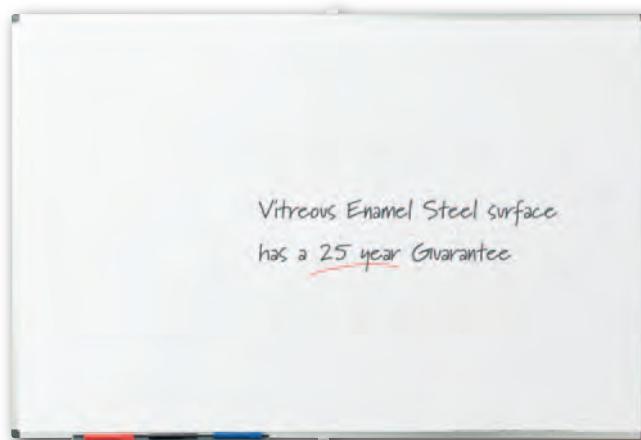

Non-returnable items, please report damages or discrepancies within 72 hours

B Glass Magnetic Whiteboard

- Incredibly stylish whiteboards, to give your rooms the finishing touch
- Works like a standard drywipe board, with standard drywipe markers and erasers
- Available in 8 sizes, right up to 2400 x 1200mm

GMW960	900 x 600mm	each	£97.16
GMW1065	1000 x 650mm	each	£116.91
GMW1290	1200 x 900mm	each	£168.06
GMW1212	1200 x 1200mm	each	£213.77
GMW1510	1500 x 1000mm	each	£221.85
GMW1812	1800 x 1200mm	each	£280.03
GMW2010	2000 x 1000mm	each	£300.46
GMW2412	2400 x 1200mm	each	£390.19



CALL US ON 01527 878348



VISIT WWW.FORWARDPRODUCTS.CO.UK

Non-returnable items, please report damages or discrepancies within 72 hours

A



A Eco-Friendly Whiteboards

- The attractive contoured 35mm wide frame is available in a choice of Aluminium (AL), Blue (BL) or Light Oak (LO) effect finishes
- Almost entirely constructed from timber industry bi-products, and recycled materials
- Quality laminate drywipe surface
- Boards can be mounted portrait or landscape with fixings provided
- Made in the UK

EFW96**	900 x 600mm	each	£31.44
EFW129**	1200 x 900mm	each	£45.41
EFW1212**	1200 x 1200mm	each	£55.06
EFW1512**	1500 x 1200mm	each	£71.04
EFW1812**	1800 x 1200mm	each	£80.55
EFW2412**	2400 x 1200mm	each	£110.50

**Please specify frame colour when ordering

Frame Options

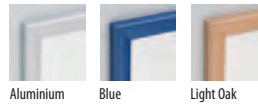

90% RECYCLED MATERIAL

ECO FRIENDLY PRODUCTS

These Eco-Friendly products are manufactured from sustainable and recycled raw materials and environmentally friendly manufacturing processes.

By weight these finished products use up to 90% recycled material, are assembled using solvent & VOC free adhesives, and all packaging uses recycled card.

We have also eliminated unnecessary plastic packaging and the product has the potential of 60% recyclability.



A Colour Edged Whiteboards

- Quality laminate drywipe surface
- Mounts flush to the wall due to its frameless design and simple 'through the board' fixings
- Choose from five bright colours with matching screw caps
- Low profile 2mm edge means boards can be mounted side by side virtually seamless
- Made in the UK

Non-returnable items, please report damages or discrepancies within 72 hours

CEW96**	900 x 600mm	each	£26.72
CEW129**	1200 x 900mm	each	£37.27
CEW1212**	1200 x 1200mm	each	£44.38
CEW1512**	1500 x 1200mm	each	£59.32
CEW1812**	1800 x 1200mm	each	£71.50
CEW2412**	2400 x 1200mm	each	£84.88

**Please specify frame colour when ordering

Frame Colour Options



Black Blue Green Red Yellow White

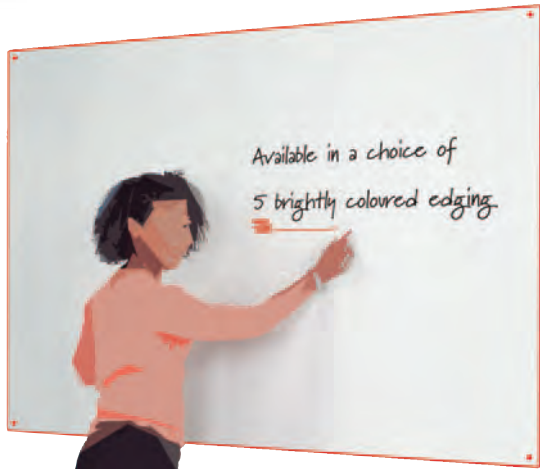

A

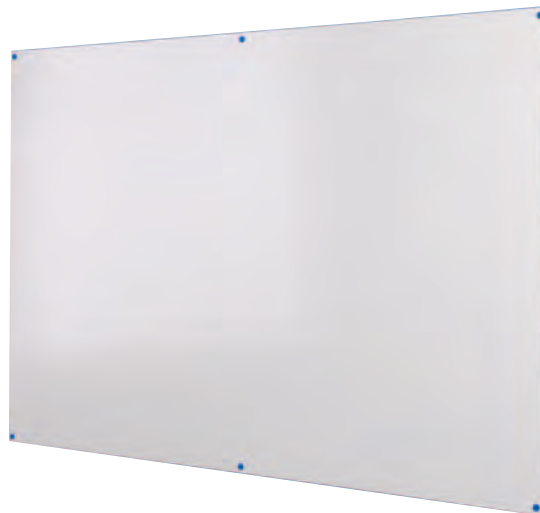

The tough ABS colour edging adds a modern accent to an everyday product

Have you seen our new range of Sienna office desking?



See pages 471-489 for details



CALL US ON 01527 878348



VISIT WWW.FORWARDPRODUCTS.CO.UK

Non-returnable items, please report damages or discrepancies within 72 hours

10 YEAR WARRANTY

A



- Magnetic drywipe surfaces
- Extremely durable, stable and safe
- Quick and easy height adjustments achievable within seconds
- Four locking castors (where illustrated)
- Available with red or blue, high gloss, powder coated frames
- Flip chart fittings (where illustrated)
- Comes complete with a manufacturer's 10 year warranty
- Full length pen ledge
- A full range of spares are available
- Where illustrated, Gratnells school storage trays are included

B



A Big A Frame Easel

- Includes two Gratnells storage trays
- White Board size: W900 x H900mm
- Height adjustable 1120, 1350, 1590 or 1800mm

BAFMEBL	Blue	each	£244.21
BAFMERD	Red	each	£244.21

B Single Sided Mobile Easel

- Includes one Gratnells storage tray
- White Board size: W600 x H900mm
- Height adjustable 1210, 1140, 1670 or 1880mm

SBMEPBL	Blue	each	£214.44
SBMEPRD	Red	each	£214.44

C



C Double Sided Mobile Easel

- Includes one Gratnells storage tray
- Front board adjustable only
- White Board size: W600 x H900mm
- Height adjustable 1220, 1440, 1680 or 1900mm

DBMEPBL	Blue	each	£260.37
DBMEPRD	Red	each	£260.37



A Double Sided Mobile Easel Landscape Style

- Includes three Gratrnels storage trays
- Boards can be stepped independently, (see illustration)
- Specifically designed for 4 – 11 year old children
- White Board size: W900 x H600mm
- Height adjustable 810, 1030 or 1350mm

DBMELBL	Blue	each	£275.69
DBMELRD	Red	each	£275.69

Non-returnable items, please report damages or discrepancies within 72 hours



A

B Large Desktop Easel

- Designed for easy transport between classrooms
- White Board size: W600 x H600mm

LMDTEBL	Blue	each	£117.20
LMDTERD	Red	each	£117.20



B

C Small Individual Desktop Easel

- Specifically designed for individual pupils
- White Board size: W600 x H300mm

SIDTEBL	Blue	each	£87.84
SIDTERD	Red	each	£87.84



C

A



A Magnetic Revolving Whiteboards

- Mobile revolving white board with pen tray and locking castors
- Board rotates 360° and will lock at any angle
- Anodised aluminium frame board
- Gridded one side and plain on the other
- 4 year warranty on board surface

EREV129	1200 x 900mm	each	£107.13
EREV1212	1200 x 1200mm	each	£127.73
EREV1215	1200 x 1500mm	each	£139.36
EREV1218	1200 x 1800mm	each	£157.27

Non-returnable items, please report damages or discrepancies within 72 hours

B



B Tilting Portable Duo Boards

- Flipchart easel and magnetic dry wipe board on one side, notice board on the other
- Ideal where space is limited
- Height adjustable
- Portable and easy to use
- Castors lock down when in use
- Includes a bracket for holding flipchart pad

DUONB127	1200 x 700mm	each	£114.01
----------	--------------	------	---------



A Royal Reading & Writing Centre

- A magnetic dry erase metal surface which also supports long chart paper, pocket charts and magnetic letters
- 24" x 34" removable and adjustable double-sided magnetic dry erase board with lines spaces 1" apart on one side – hangs long or wide
- Built-in big book storage rack
- Shelf with two built-in small tubs for marker storage
- Two magnetic bulldog clips
- Removable and width adjustable snap on hooks for chart paper, pocket charts etc
- Removable and adjustable spring loaded book/marker ledge fastens securely to front and back at nine different levels
- Four clear sliding tubs for ease of access
- Four locking castors
- Foot activated brake system
- Ten year frame warranty
- Size 76cm x 78.75cm x 145cms



A

LC500 each £315.56



Non-returnable items, please report damages or discrepancies within 72 hours

B Junior Mobile Tilting Magnetic Whiteboard

- Practical floor standing whiteboard with plain, gridded or lined magnetic surfaces
- Double sided whiteboard mounted in a mobile frame
- Board can pivot and lock at a 40deg angle, therefore ideal for resting books or artwork on the full width ledge
- 4 castors 2 of which are braked
- Overall height 1300mm
- Choose from white frame with anodised aluminium board trim or red frame with multi-coloured board trim and a choice of grid or lines



B

DJMWWH	White Frame	each	£116.95
DJMWRE	Red Frame	each	£142.26

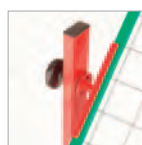

CALL US ON 01527 878348



VISIT WWW.FORWARDPRODUCTS.CO.UK

Non-returnable items, please report damages or discrepancies within 72 hours

A



B



C



Standard Felt Colours

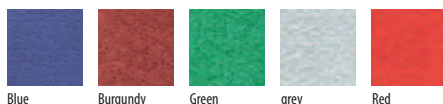

Please Specify:
Felt/fabric colour

A Unframed Noticeboards

- These frameless pinboards are made from high quality board and felt
- Fire resistant and colour fast
- Available in Blue (BL), Green (GR), Red (RD), Silver (SV) & Wine (WN)
- Can be made to a custom size - POA
- 3 largest sizes are supplied in 2 parts

UNB9060**	900 x 600mm	each	£19.27
UNB129**	1200 x 900mm	each	£26.93
UNB1212**	1200 x 1200mm	each	£32.30
UNB1512**	1500 x 1200mm	each	£43.95
UNB1812**	1800 x 1200mm	each	£47.77
UNB2412**	2400 x 1200mm	each	£57.99

**Please specify colour when ordering

B Standard Noticeboards

- Made in the UK to the highest standards
- Felt surface accepts Velcro® as well as pins - colour fast to BS1006
- Available in 5 standard felt colours - Blue (BL), Burgundy (BG), Red (RD), Green (GR) or Grey (GY) & special fabrics for an extra charge. Please call for more information
- Other sizes/colours are available – please enquire (P.O.A.)
- Flush fix corners conceal wall fixings (supplied)
- Fire retardant fabric

NBS96**	600 x 900mm	each	£23.64
NBS129**	900 x 1200mm	each	£30.44
NBS1212**	1200 x 1200mm	each	£37.63
NBS1512**	1500 x 1200mm	each	£51.26
NBS1812**	1800 x 1200mm	each	£53.40
NBS2412**	2400 x 1200mm	each	£63.44

** Please specify colour when ordering, see swatch at bottom of page

C Standard Tamperproof Noticeboards

- Inexpensive solution to protect displays from casual interference
- Each door secures with 2 matching lock for convenience
- Felt surface accepts Velcro® as well as pins - colour fast to BS1006
- Available in 5 standard felt colours - Blue (BL), Burgundy (BG), Green (GR), Grey (GY) or Red (RD) and special fabrics for an additional charge. Please call for more information
- Other sizes/colours are available – please enquire (P.O.A.)
- Fire Retardant Fabric

Single Door

LNB21**	600 x 450mm	each	£48.57
LNB32**	600 x 900mm	each	£56.91
LNB33**	900 x 900mm	each	£72.89
LNB43**	1200 x 900mm	each	£86.70
LNB44**	1200 x 1200mm	each	£116.56

Double Doors

LNB64**	1200 x 1800mm	each	£172.84
LNB84**	1200 x 2400mm	each	£207.95

** Please specify colour when ordering, see swatch below



Non-returnable items, please report damages or discrepancies within 72 hours

A Contemporary Unframed Noticeboard

- Eye catching range of noticeboards in bright contemporary felt colour finishes
- A selection of 6 fabric colours: Cyan (CY), Lilac (LC), Magenta (MG), Orange (OR) Bright Green (BG) & Purple (PU)
- Designed for use with both pins and Velcro
- 3 largest sizes are supplied in 2 parts

UNC960**	900 x 600mm	each	£25.78
UNC1290**	1200 x 1200mm	each	£34.07
UNC1512**	1500 x 1200mm	each	£53.22
UNC1812**	1800 x 1200mm	each	£67.15
UNC2412**	2400 x 1200mm	each	£67.53

** Please specify colour when ordering, see swatch at bottom of page



A

B Contemporary Framed Noticeboards

- Brighten up your school with these extra stylish noticeboards
- Available in 6 stylish felt options
- Made in the UK to the highest specification
- Accepts Velcro fasteners and pins
- 5 sizes available
- 2 largest sizes are supplied in 2 parts

CNB960**	900 x 600mm	each	£31.38
CNB1290**	1200 x 900mm	each	£43.62
CNB1512**	1500 x 1200mm	each	£63.41
CNB1812**	1800 x 1200mm	each	£68.81
CNB2412**	2400 x 1200mm	each	£85.76

** Please specify colour when ordering, see swatch at bottom of page



B

C Contemporary Tamperproof Noticeboards

- Brighten up your school with these extra stylish noticeboards
- Available in 6 stylish felt options
- Made in the UK to the highest specification
- Accepts Velcro fasteners and pins
- 4 sizes available

1 Door

CTPNB960**	900 x 600mm	each	£77.57
CTPNB990**	900 x 900mm	each	£103.87
CTPNB1290**	1200 x 900mm	each	£111.35
CTPNB1812**	1800 x 1200mm	each	£204.60

** Please specify colour when ordering, see swatch at bottom of page



C

Please Specify:
Felt/fabric colour

Contemporary Felt Colours

Purple	Magenta	Lilac	Orange	Cyan	Bright Green

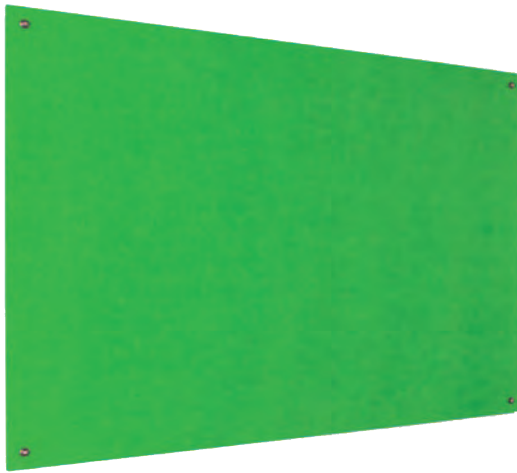

Please Specify:

Fabric colour

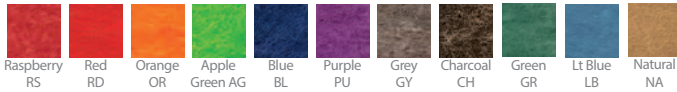

Frameless EcoColour® Noticeboards

A fantastic range of recycled noticeboards that are not only fire resistant but also have acoustic properties

- Fire Resistant to Class 0
- Made from recycled materials
- Acoustic properties up to NRC 0.8
- Self- coloured pinnable core
- Available in 11 different colours
- 3 largest sizes are supplied in 2 parts

DEUFB32*	W900 x H600mm	£28.23
DEUFB43 *	W1200 x H900mm	£47.90
DEUFB44 *	W1200 x H1200mm	£61.43
DEUFB54 *	W1500 x H1200mm	£74.70
DEUFB64 *	W1800 x H1200mm	£91.86
DEUFB84 *	W2400 x H1200mm	£123.24

*Please specify colour when ordering



Please Specify:

Fabric colour

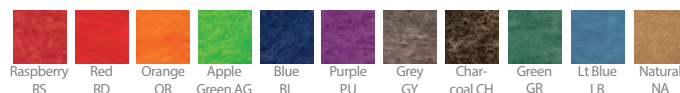

Aluminium Frame EcoColour® Noticeboards

A fantastic range of recycled noticeboards with aluminium frame that are not only fire resistant but also have acoustic properties

- Fire Resistant to Class 0
- Made from recycled materials
- Acoustic properties up to NRC 0.8
- Self- coloured pinnable core
- Available in 11 different colours

DE22632*	W900 x H600mm	£38.37
DE22643*	W1200 x H900mm	£68.54
DE22644*	W1200 x H1200mm	£84.61
DE22654*	W1500 x H1200mm	£100.97
DE22664*	W1800 x H1200mm	£122.02
DE22684*	W2400 x H1200mm	£151.38

* Please specify colour when ordering



Light Oak Effect Premium Aluminium Frame EcoColour® Tamperproof Noticeboard

Stunning light oak effect aluminium frame with EcoColour® recycled material which is not only fire resistant but also has acoustics properties.

- Fire resistant to Class 0
- Made from recycled material
- Acoustic properties up to NRC 0.8
- Attractive contour frame design
- Available in 11 different colours

Single Door

DECBT32*	W600 x H900mm	£102.40
DECBT43*	W900 x H1200mm	£143.97
DECBT44*	W1200 x H1200mm	£171.01

Double Door

DECBT64*	W1800 x H1200mm	£251.61
DECBT84*	W2400 x H1200mm	£303.00

* Please specify colour when ordering

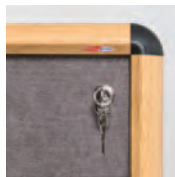

Please Specify:

Fabric colour



Non-returnable items, please report damages or discrepancies within 72 hours

Top Hinged Tamperproof EcoColour® Fire Resistant Noticeboards

- Top hinged lockable noticeboards with door supports
- Ideal for use in busy corridors
- Doors open upwards and are kept in place with support stays
- 2 locks per doors with matching keys
- Range of 11 standard colours

Single door

DE27301*	W900 x H600mm	£118.19
DE27302*	W900 x H900mm	£145.97
DE27303*	W900 x H1200mm	£157.93
DE27305*	W1200 x H900mm	£157.81
DE27304*	W1200 x H1200mm	£186.36

Double door

DE2736*	W1800 x H900mm	£289.82
DE2738*	W1800 x H1200mm	£313.47
DE2737*	W2400 x H1200mm	£374.15

*Please specify colour when ordering.



Please Specify:

Fabric colour

EcoColour® Resist-a-Flame® Range

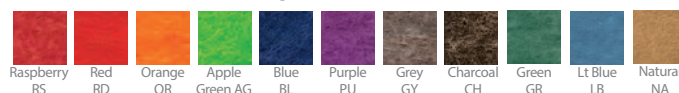

A

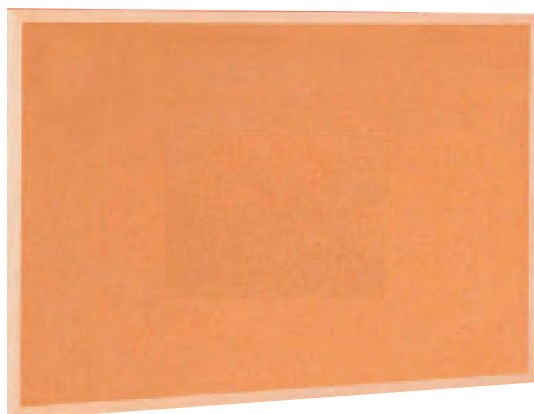

A Economy Cork Boards

- Lightweight double sided pin board
- Felt one side, cork on the other
- Supplied with fixings & free pins

F04071	600 x 900mm	each	£13.85
--------	-------------	------	--------

Non-returnable items, please report damages or discrepancies within 72 hours

B

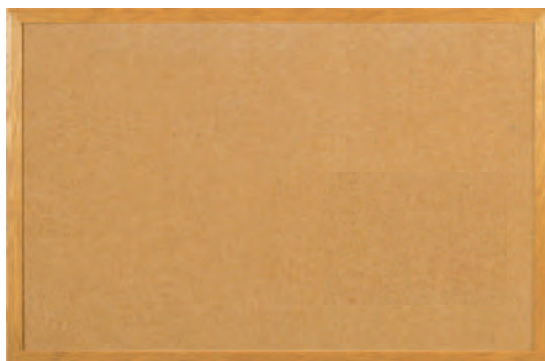

B Premium Cork Boards with MDF Frame

- Thick resilient cork for everyday use

MDFCK96	900 x 600mm	each	£27.47
MDFCK129	1200 x 900mm	each	£36.65
MDFCK1812	1800 x 1200mm	each	£53.96
MDFCK2412	2400 x 1200mm	each	£63.65

C

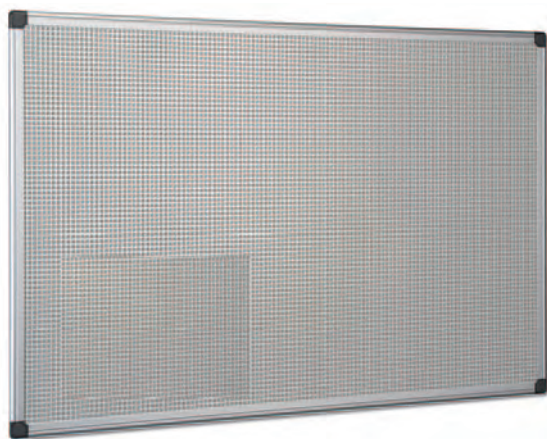

C Magnetic 'Pin Boards'

- Gridded metal over a grey cork notice board allows both pushpins, and magnets to be used
- Smart aluminium frame
- Hanging devices included
- Magnets and push pins included

42203	600 x 450mm	each	£39.57
42030	900 x 600mm	each	£57.93
42501	1200 x 900mm	each	£96.41



A Felt Noticeboards with Wooden MDF Frame

- Flame retardant felt to BS476 part 7 class 1
- All fabric is colourfast to BS1006
- Fixings pack included
- Available in Blue-BL Red-RD Green-GR Grey-GY Burgundy-BG

MDFFB96*	900 x 600mm	each	£31.72
MDFFB129*	1200 x 900mm	each	£44.67
MDFFB1812*	1800 x 1200mm	each	£72.10
MDFFB2412*	2400 x 1200mm	each	£96.01

*Please specify colour when ordering



A



B Eco-Friendly Noticeboards

- Ever popular range offering an environmental choice at economical prices
- Almost entirely constructed from timber industry bi-products and recycled materials
- Attractive contoured 35mm wide frame is available in a choice of Light Oak (LO), Mahogany (MG) or Aluminium (AL) effect finishes
- Available in 5 popular felt colours: Blue (BL), Burgundy (BG), Green (GR), Grey (GY), Red (RD) or Traditional Cork (CK)
- Felt accepts both pins and Velcro®, cork option is pinnable

ECF96*	900 x 600mm	£25.42
ECF129*	1200 x 900mm	£34.72
ECF1212*	1200 x 1200mm	£39.53
ECF1512*	1500 x 1200mm	£53.43
ECF1812*	1800 x 1200mm	£62.03
ECF2412*	2400 x 1200mm	£78.62

* Please specify frame type and board colour when ordering



B

Frame Options



Please Specify:

1. Frame finish
2. Felt/fabric colour



CALL US ON 01527 878348



VISIT WWW.FORWARDPRODUCTS.CO.UK

A



A Cork/Drywipe Boards

- Lightweight dual purpose boards
- Half drywipe and half cork pinboard surface
- Supplied with drywipe pen and pins

23010BQ	600 x 400mm	each	£5.86
27010BQ	900 x 600mm	each	£10.83



B



B Duo Felt/Whiteboards

- Twin surface boards offer the flexibility of both a dry-wipe whiteboard and a pinnable surface felt or cork noticeboard
- Drywipe surface is magnetic
- Felt surface accepts Velcro® as well as pins - colour fast to BS1006
- Available in 5 standard felt colours - Blue (BL), Burgundy (BG), Green (GR), Grey (GY) or Red (RD)
- Attractive anodised aluminium trim with concealed corner fixings (supplied)
- Made in UK

COMF32**	900 x 600mm	each	£26.32
COMF43**	1200 x 900mm	each	£38.12
COMF64**	1800 x 1200mm	each	£65.76

** Please specify colour when ordering

C



C Snap Display Poster Frames

- Attractive anodised aluminium frame
- Use to display information and signs
- Quick and easy to fit
- Clear plastic cover protects contents

SNFA4	A4	each	£13.91
SNFA3	A3	each	£18.62
SNFA2	A2	each	£20.88

D



D Photo & Certificate Frames

- Choose from smart black wooden frame or economical frameless version
- Non glass break resistant front
- Simple metal clips hold the contents in place, easy to open and insert display
- A4 black frame has back stand

F00400PHT	A4 Black Frame	each	£8.37
F00402PHT	A3 Black Frame	each	£10.26



BusyFold® Light Display Kits

Lightweight folding panel system with 600 x 900mm PVC framed panels which are linked with flexible hinging and clip on top of each other.

- The 7 and 10 panel unit features triangular plinth/s for displaying 3D objects
- Double sided panels are covered in a choice of 14 loop nylon colours which are fire retardant to BS5867
- Accepts Velcro®
- All kits include headers and a carrying bag

** Please state frame and felt colour required
- frames available in grey or black

Non-returnable items, please report damages or discrepancies within 72 hours

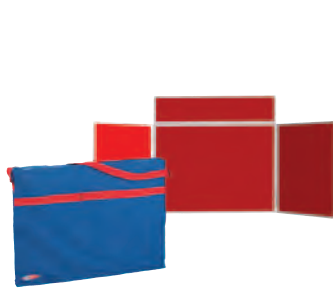

BusyFold Tabletop Landscape H x W

DBL3** 800 x 1800mm £76.10



BusyFold 6 Kit H x W

DB6** 2000 x 1800mm £163.45

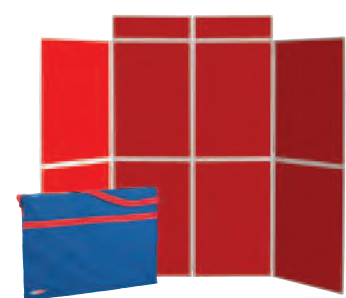

BusyFold 8 Kit H x W

DB8** 2000 x 2400mm £220.08



BusyFold Tabletop Portrait H x W

DB3P** 1100 x 1800mm £90.43



BusyFold 7 Kit H x W

DB7** 2000 x 1800mm £203.86

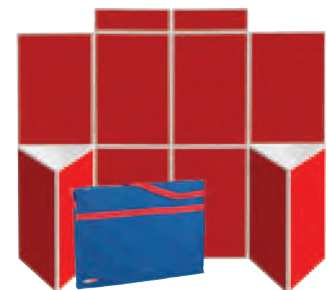

BusyFold 10 Kit H x W

DB10** 2000 x 2400mm £285.00

Please Specify:

Felt colour



Blue & Grey Royal Blue Emerald Alpha Red Light Blue Burgundy Black Yellow Orange Cyan Apple Purple Magenta Lilac



CALL US ON 01527 878348



VISIT WWW.FORWARDPRODUCTS.CO.UK

A



A Radio Controlled Clock

- Radio controlled office wall clock with a stylish metal case.
- 300mm diameter
- Brushed steel case with glass lens
- Keeps perfect time by itself. Never 'change the time' again!

RWC	Radio Controlled	each	£17.71
-----	------------------	------	--------

B



B The Original Exam Clock

- Large 300mm clock
- 12/24hr
- Plastic case
- Arabic dial
- Takes 1 AA battery (not included)

EWC	Exam Clock	each	£9.22
-----	------------	------	-------

C



C Silver Office Wall Clock

- Stylish office wall clock in silver
- 250mm diameter
- Plastic case
- Glass lens
- Arabic dial
- Takes 2 AA batteries (not included)

OWC	Office Wall Clock	each	£12.08
-----	-------------------	------	--------



A Colourful Wall Clocks

- Battery not included (1 x AA battery required)
- 255mm diameter

92301	White	each	£13.21
92302	Black	each	£13.21
92303	Red	each	£13.21
92308	Blue	each	£13.21



A

B Lockable Key Cabinets

- Features metal key hanger strips
- All steel construction available in grey finish
- Includes wall fixing kit, cylinder lock with two keys and key labelling strips

32881	20 Key	each	£16.91
32883	48 Key	each	£22.22
32886	80 Key	each	£31.42



B

C First Aid Wall Cabinets

- Sturdy, lockable, first aid metal wall cabinets supplied with internal shelves, first aid sticker, wall fixing points and 2 keys
- Ideal for preventing pilfering of first aid kit
- These units are supplied empty

Single Door 50 x 30 x 12 cm

11126	each	£38.04
-------	------	--------

Double Door 60 x 50 x 12.5 cm

11127	each	£69.25
-------	------	--------



C



CALL US ON 01527 878348



VISIT WWW.FORWARDPRODUCTS.CO.UK



White Orchid



Greenaloe



Green Ficus



Yucca Rostrata



Heliconia



Indoor Plants

- Instantly enhance reception areas or offices with this great selection of lifelike plants
- No watering & no withering plants or dropping leaves

R211111	White Orchid - Maxi White - H600mm	£93.91
R211116	Greenaloe Scarlet - H1300	£251.80
R211117	Green Ficus Black - H1900mm	£265.40
R211118	Yucca Rostrata Black - H1400mm	£265.40
R211119	Heliconia QR43 Black - H1800mm	£353.87





Buxus Ball



Entrance Spiral



Pyramid Buxus



Bay Ball - Silver



Yellow Pansy



Morning Glory - Window box

Outdoor Plants

- Bring life and vitality to your main entrance or carpark area without the hassle of attending to them

R211121	Buxus Ball LE30 Black - H900mm	£251.80
R211122	Entrance Spiral - H1600mm	£326.65
R211123	Pyramid Buxus LE30 Black - H1200mm	£287.52
R211126	Bay Ball QR43 Silver - H1400mm	£265.40
R211127	Morning Glory Window Box PT2 - W1000mm	£125.90
R211128	Red Geranium Window Box PT1 - W1000mm	£167.86
R211129	Yellow Pansy MHB1 - D400mm	£93.91



Red Geranium - Window Box



CALL US ON 01527 878348



VISIT WWW.FORWARDPRODUCTS.CO.UK



15

Office Seating

Operator Seating	427-432
Task Seating	434-438
Manager & Executive Seating	439-440
Backcare Seating	441-442
Conference Seating	443-448,450
Executive Conference Seating	449



Harlech Chair

- A comfortable operator chair to help you feel supported throughout the day
- Height adjustable ratchet back
- Available with adjustable arms, seat slide and pump up lumbar support
- Popular fabric options shown below. Many other fabric options available, please see ranges and price details on pages 561-568

T210251*	High Back Chair	£156.52
T210252*	High Back Chair with Adj Arms	£175.33
T210253	Polished Aluminium Base	£30.85
T210254	Seat Slide	£21.82
T210255	Pump Up Lumbar Support	£21.82

* Please specify fabric colour



Please see Important Furniture Ordering Information on page 306 before placing your furniture order

Popular Fabric Colour Options Standard Fabric - Advantage



Charcoal Clipper Wine Aqua Purple

Premium Fabric – Aquarius (add 35% to prices)



Rhino Purple Tombola Pascal Poison

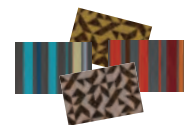

See pages 561-568 for further fabric options



Miranda Mesh Back Operator Chair

- Deep cushioned seat for extra comfort with a mesh back
- Free-float ride quality allows the chair to follow your movement or have the adjustment fixed in a position to suit you!
- Available with adjustable arms
- 5 Year Guarantee
- Mesh back available in Blue, Black, Green, Orange, Red or White - please specify when ordering
- Popular fabric options shown on previous page. Many other fabric options available, please see ranges and price details on pages 561-568



T210271*	Miranda Mesh Back	£175.60
T210272*	Miranda Mesh Back with Adjustable Arms	£212.12
T210273	Polished Aluminium Base	£31.61
T210274	Seat Slide	£25.64

* Please specify mesh colour and fabric colour



Now available in anti-microbial woven fabric, effective against Covid-19 see page 565

Please see Important Furniture Ordering Information on page 306 before placing your furniture order





Carlisle Chair

- Great support with large waterfall-front seat and well cushioned back
- UK fire retardant foam and tough-wearing fabric
- 1 year guarantee
- Adjustable, fixed or floating back setting
- Available in Havana and Scuba fabrics only

		1-2	3+
T211171*	Carlisle Medium Back	£87.10	£73.45
T211172*	Carlisle High Back	£90.25	£76.91
T211174*	Carlisle Medium Back with Fixed Arms	£108.08	£92.96
T211175*	Carlisle High Back with Fixed Arms	£109.20	£93.52

* Please specify fabric colour

Fabric Colour Options

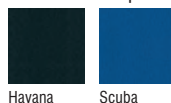

Perfect for ICT and Office Environments

Please see Important Furniture Ordering Information on page 306 before placing your furniture order

5 YEAR GUARANTEE

Whitley Chair

- Smart looking operator chair that compliments any office or classroom
- Deep upholstery for comfort and support
- Ratchet back height adjustment
- 5 year guarantee
- Popular fabric options shown below. Many other fabric options available, please see ranges and price details on pages 561-568

T210181*	Whitley High Back	£153.88
T210182*	Whitley with Fixed Arms	£179.08
T210183*	Whitley with Adj. Arms	£186.04
T210184	Polished Aluminium Base	£30.16
T210185	Seat Slide	£25.64
T210186	Pump Up Lumbar Support	£27.97

* Please specify fabric colour



Whitley Chair

Fixed Arms

Adjustable Arms & Aluminium Base

Popular Fabric Colour Options

Standard Fabric - Advantage



Charcoal

Clipper

Wine

Aqua

Purple

Premium Fabric – Aquarius (add 35% to prices)



Rhino

Purple

Tombola

Pascal

Poison

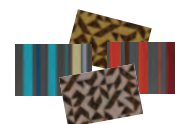

See pages 561-568 for further fabric options



Vaneto Chair

- Comfortable, durable and inexpensive range of quality task chairs
- Twin lever mechanism for easy adjustments
- Available in medium and high back options
- 5 year guarantee
- Popular fabric options shown on previous page. Many other fabric options available, please see ranges and price details on pages 561-568

T210191*	Vaneto Medium Back	£99.98
T210192*	Vaneto Medium Back with Fixed Arms	£116.48
T210193*	Vaneto Medium Back with Adjustable Arms	£132.14
T210194*	Vaneto High Back	£109.54
T210195*	Vaneto High Back with Fixed Arms	£126.06
T210196*	Vaneto High Back with Adjustable Arms	£141.70
T210197	Polished Aluminium Base	£30.16
T210198	Seat Slide	£23.15
T210199**	Pump Up Lumbar Support	£25.25

* Please specify fabric colour

** Only available for high back chair



High Back & Fixed Arms



Medium Back



Medium Back & Fixed Arms



Medium Back & Adjustable Arms



High Back



High Back, Adjustable Arms & Aluminium Base

Now available in anti-microbial woven fabric, effective against Covid-19 see page 565





Helmsley Chair

- Ergonomic operator chair
- Sculptured seat and back for greater comfort
- 2 lever mechanism
- Hand wheel back height adjustment
- 5 year guarantee
- Seat height 450 - 480mm, width 480mm, depth 450mm
- Popular fabric options shown on next page. Many other fabric options available, please see ranges and price details on pages 561-568

T211221*	High Back Operator Chair	£151.09
T211222*	High Back Operator Chair with Fixed Arms	£173.24
T211223*	High Back Operator Chair with Adjustable Arms	£186.26

* Please specify fabric colour



Toledo Ergonomic Chair

- An ergonomic chair for users with back pain, or for those who require an extra degree of comfort
- Triple lever mechanism with adjustable tension control
- Superior, free float ride quality and the facility to independently set the seat and back angle – great for stiff backs and aching joints
- Large, deep cushioned seat & back
- Ratchet back height adjustment
- 5 year guarantee
- Popular fabric options shown on next page. Many other fabric options available, please see ranges and price details on pages 561-568



High Back



Fixed Arms & Aluminium Base



Adjustable Arms

T210231*	Toledo High Back	£167.78
T210232*	Toledo High Back with Fixed Arms	£193.00
T210233*	Toledo High Back with Adjustable Arms	£199.96
T210234	Polished Aluminium Base	£32.87
T210235	Seat Slide	£25.64
T210236	Pump Up Lumbar Support	£27.97

* Please specify fabric colour



Fyvie Chair

- Superior operator chair range for the discerning buyer
- Large and deep cushioned seat
- 2 lever mechanism
- Oval sculptured back for increased comfort
- Optional aluminium base
- Matching visitor chairs
- Visitor chairs have 25mm steel cantilever frame
- Seat height 470 - 600mm, width 455mm depth 440mm
- Popular fabric options shown below. Many other fabric options available, please see ranges and price details on pages 561-568

T211241*	Fyvie Operator Chair	£128.45
T211242*	Fyvie with Fixed Arms	£154.20
T211243*	Fyvie with Adjustable Arms	£163.49
T211244	Polished Aluminium Base	£32.71
T211245*	Fyvie Visitor Chair	£139.61
T211246*	Visitor Chair with Fixed Arms	£162.97
T211247	Chrome Frame for Visitor Chair	£30.37

* Please specify fabric colour

 Now available in anti-microbial woven fabric, effective against Covid-19 see page 565



Operator Chair



Adjustable Arms & Aluminium Base



Visitor Chair Chrome Frame



Visitor Chair with Arms, Chrome Frame

Popular Fabric Colour Options
Standard Fabric - Advantage

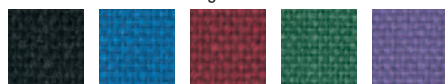

Charcoal

Clipper

Wine

Aqua

Purple

Premium Fabric – Aquarius (add 35% to prices)



Rhino

Purple

Tombola

Pascal

Poison

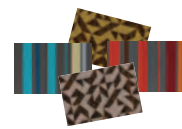

See pages 561-568 for further fabric options



CALL US ON 01527 878348



VISIT WWW.FORWARDPRODUCTS.CO.UK



Now available in anti-microbial woven fabric, effective against Covid-19 see page 565

Atlanta Ergonomic Task Chair

- Heavy duty ergonomic task chair for 24hrs/day use
- Inflatable lumbar support and extra-large, cushioned seat and back for maximum comfort
- Available with adjustable arms
- Ratchet back height adjustment
- With adjustable tension control and lumbar support as standard
- Popular fabric options shown on next page. Many other fabric options available, please see ranges and price details on pages 561-568

T210281*	Atlanta Ergonomic	£297.32
T210282*	Atlanta Ergonomic with Adjustable Arms	£342.54
T210283	Polished Aluminium Base	£31.61
T210284	Seat Slide	£25.64

* Please specify fabric colour

Please see Important Furniture Ordering Information on page 306 before placing your furniture order

Castelo Mesh Back Task Chair

- Black mesh back
- Ratchet back height adjustment
- Lumbar support back
- Available with adjustable arms
- 5 year guarantee
- Popular fabric options shown on next page. Many other fabric options available, please see ranges and price details on pages 561-568

T210291*	Castelo Mesh Back	£252.98
T210292*	Castelo Mesh Back with Adjustable Arms	£292.98
T210293*	Castelo Mesh Back with Synchro Mechanism	£273.86
T210294*	Castelo Mesh Back with Synchro Mechanism & Adj. Arms	£313.84
T210295	Polished Aluminium Base	£36.12
T210296	Seat Slide	£27.72

* Please specify fabric colour



5 YEAR
GUARANTEE



Please see Important Furniture Ordering Information on page 306 before placing your furniture order



Lift back 7 increments to desired height, 8th position returns back to lowest setting

Lift arm by lifting lever under the arm and adjusting to suit

Pump up lumbar support to a comfortable inflation and release with push button

Lift lever to adjust sliding seat, release to lock in position (left lever)

Lift levers to release back synchronised mechanism. Back and seat are now in free float. Push levers down to lock in position.

Turn to adjust tension depending upon operator's weight

Lift and hold lever to operate gas height adjustment. Set to desired height and release. (Front Lever)



Stokesay Chair

- Brilliant value for money task chair
- Highly ergonomic with contoured seat and back
- Synchronised or independent mechanism - synchronised moves seat and back together, independent mechanism adjusts them separately
- Pump up lumbar support
- Ratchet back height adjustment
- 5 year guarantee
- Seat height 500-600mm, width 510mm, depth 480mm
- Popular fabric options shown below. Many other fabric options available, please see ranges and price details on pages 561-568



T211311*	With Black Base	£244.05
T211312*	With Black Base & Adj. Arms	£281.03
T211313*	With Chrome Base	£281.03
T211314*	With Chrome Base & Adj. Arms	£329.10

* Please specify fabric colour
 **Please choose synchronised or independent mechanism

Popular Fabric Colour Options

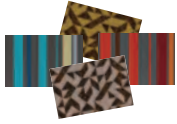
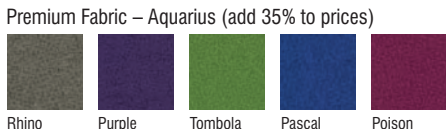
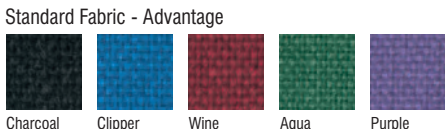

See pages 561-568 for further fabric options



Wentworth

- Sophisticated technical mesh back
- Weight responsive self-adjusting synchronised mechanism
- Antishock back tilt locking system (4 Positions)
- CMHR Moulded seat foam
- 685mm polished aluminium or black nylon 5 star base
- 60mm twin hard wheeled black castors
- Height adjustable lumbar support
- 50mm Sliding seat depth adjustment
- Popular fabric options shown below. Many other fabric options available, please see ranges and price details on pages 561-568
- **Please see Important Furniture Ordering Information on page 306 before placing your furniture order**

T211321*	Mesh Task Chair	£267.57
T211322*	Mesh Draughtsman Chair	£338.27
T211323*	Mesh Cantilever Chair	£249.51

* Please specify fabric colour

Additional Options

T211325	1D Arms (Height Adj)	£34.31
T211326	3D Arms (Height, Depth & 30° Rotation Adj)	£56.85
T211327	Polished Aluminium Base	£35.01
T211328	Contrasting Side Panel	£13.87
T211329	Chrome Frame	£23.39

Arm Options



1D Arm



3D Arm

Base Options



PB Base



CF Frame

User Controls

Wentworth's design is clean, crisp and uncluttered. All of the user controls are well arranged and located within easy ergonomic reach of the user.

- 1 Seat height adjustment.
- 2 Backrest tilt.
- 3 Seat slide adjustment.
- 4 Armrest height adjustment.
- 5 Height adjustable lumbar support.

Popular Fabric Colour Options Standard Fabric - Advantage

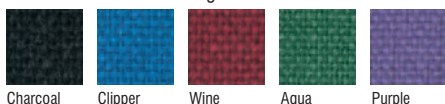

Charcoal

Clipper

Wine

Aqua

Purple

Premium Fabric – Aquarius (add 35% to prices)



Rhino

Purple

Tombola

Pascal

Poison

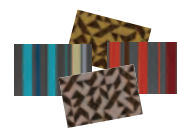

See pages 561-568 for further fabric options



Now available in anti-microbial woven fabric, effective against Covid-19 see page 565



Rochester Chair

- High back executive style chair at incredible value
- Superb back support
- Pump up lumbar support
- Adjustable seat and back angle
- Height adjustable arms and headrest available
- Available with chrome base and arms POA
- 5 year guarantee
- Seat height 480 - 640mm, width 530mm, depth 500mm
- Popular fabric options shown on previous page. Many other fabric options available, please see ranges and price details on pages 561-568

T211341*	Rochester Chair No Arms	£263.78
T211342*	Rochester Chair with Adjustable Arms	£329.10
T211343*	Rochester Chair with Headrest + Adjustable Arms	£409.22

* Please specify fabric colour

Please see Important Furniture Ordering Information on page 306 before placing your furniture order



Penrith Chair

- Executive task chair with cushioned rolled seat and double curvature back
- Synchronised mechanism
- Style base in black or chrome
- Height adjustable back
- Medium back chair also available, please call for details
- Popular fabric options shown on previous page. Many other fabric options available, please see ranges and price details on pages 561-568

T211351*	With Black Style Base	£327.26
T211352*	With Black Style Base - Adj. Arms	£387.11
T211353*	With Chrome Style Base	£374.36
T211354*	With Chrome Style Base - Adj. Arms	£432.95
T211355	Seat Slide	£29.96
T211356	Lumbar Support	£29.96

* Please specify fabric colour





Excel Cantilever Chair has a Chrome Frame as Standard



Stylish Curved Mesh Back



Back Lumbar Support - Adjustable from a Seated Position

Excel Mesh Back Chairs

- Enjoy stunning looks and high levels of comfort with this new mesh back range
- Optional unique lumbar support on task chair allows operator to adjust the lumbar support from a seated position
- 5 year guarantee
- **Please see Important Furniture Ordering Information on page 306 before placing your furniture order**



Excel Mesh Back Task Chair

- Seat slide as standard
- Popular fabric options shown on next page. Many other fabric options available, please see ranges and price details on pages 561-568

T211361*	Mesh Back Chair	£324.35
T211362*	Mesh Back Chair - Adjustable Arms	£367.68
T211363	Optional Polished Base	£38.08
T211365	Optional Soft Tyre Castors	£27.58
T211366	Optional Adjustable Lumbar Support	£32.83

* Please specify fabric colour

Excel Mesh Back Cantilever Chair

- Polished chrome frame
- Black mesh back as standard
- Popular fabric options shown on next page. Many other fabric options available, please see ranges and price details on pages 561-568

T211792*	Cantilever Chair	£315.15
T211794	Optional Grey Mesh Back	£19.73
T211795	Optional White Mesh Back	£19.73

* Please specify fabric colour





Unique Stepped Back Design

Two Tone Fabric Available - Please Call for Price

Special Angled Arms for ease of Keyboard Use

Style Pedestal Type Base

+ Now available in anti-microbial woven fabric, effective against Covid-19 see page 565

Excel Task Chair

- Beautiful and high quality task chair
- Unique stepped back design and waterfall seat
- Style pedestal type base as standard
- Seat slide as standard
- Optional adjustable arms are specially angled to allow for ease of use when typing
- 5 year guarantee
- Popular fabric options shown below. Many other fabric options available, please see ranges and price details on pages 561-568
- **Please see Important Furniture Ordering Information on page 306 before placing your furniture order**



See pages 561-568 for fabric colour options

Excel Optional Features

T211383*	High Back Chair	£287.58
T211384*	High Back Chair with Adjustable Arms	£330.91

T211391	Polished Base	£38.08
T211393	Soft Tyre Castors	£27.58
T211394	Pump Up Lumbar	£32.83

* Please specify fabric colour

Popular Fabric Colour Options
Standard Fabric - Advantage

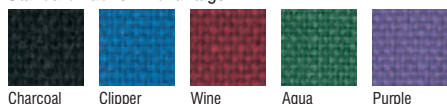

Premium Fabric – Aquarius (add 35% to prices)

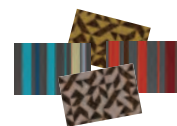

See pages 561-568 for further fabric options



CALL US ON 01527 878348



VISIT WWW.FORWARDPRODUCTS.CO.UK

Giovanni Executive Chair

- Premium managers task chair with inflatable lumbar support
- Set the chair up how you like for maximum comfort with its operator plus mechanism and multi-adjustable headrest and arms
- Ratchet back height adjustment
- 5 year guarantee
- Popular fabric and vinyl options shown below. Many other fabric options available, please see ranges and price details on pages 561-568

T210411* Giovanni with Adj. Arms £462.51

* Please specify fabric colour



Now available in anti-microbial woven fabric, effective against Covid-19 see page 565



Elegance Executive Chair

- Classy executive managers chair with stylish looks and superb comfort
- Set the chair up for you with inflatable lumbar support, back height adjustment, a seat slider and adjustable arms
- 5 year guarantee
- Popular fabric and vinyl options shown below. Many other fabric options available, please see ranges and price details on pages 561-568

T210421* Elegence with Adj. Arms £431.32

* Please specify fabric colour

Popular Fabric Colour Options
Standard Fabric - Advantage



Anti-microbial Just Colour Vinyl (add 15% to prices)

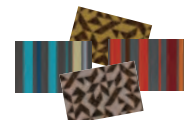

See pages 561-568 for further fabric options



Conquest Chair

- A generously cushioned high back executive armchair with pronounced head rest and attractive stitching detail
- Soft Black leather
- Matching padded black arms

T211441	Conquest Chair	£197.61
---------	----------------	---------



Please see Important Furniture Ordering Information on page 306 before placing your furniture order

Balmoral Chair

- Soft bonded leather finish
- Twin lever heavy duty mechanism
- Aluminium base and arm rest
- Classy ribbed design
- Available in black or ivory
- Matching cantilever visitors chair

T211481	Black Chair	£313.63
T211482	Ivory Chair	£313.63
T211483	Black Cantilever Chair	£276.95
T211484	Ivory Cantilever Chair	£276.95



CALL US ON 01527 878348



VISIT WWW.FORWARDPRODUCTS.CO.UK

Dual layer Reflexion heat reactive foam for correct degree of back support and ultimate long term comfort

Dual layer Reflexion heat reactive seat foam for pressure relieving body support
The seat has 65mm of horizontal travel for correct support behind the knees

Stockholm Posture Chair

The Stockholm back care chair has been tested to the rigorous strength and stability standard, BS5459 and is guaranteed structurally for 5 years whilst in 24 hour per day use by persons weighing up to 150kg.

The back and seat recline together in a fixed 2:1 ratio. The tension of the recline is adjusted by a rotating handwheel. The recline function can be left unlocked in dynamic freefloat mode. For added comfort the back angle is independently adjustable

Inflatable lumbar support for individually tailored, "S" shaped spinal curve

Back height is adjustable for precise positioning of lumbar support

Synchro Plus with 6 adjustable functions to allow all users to achieve healthy and comfortable set up

Gas lift suitable for 150Kg user weight

 Now available in anti-microbial woven fabric, effective against Covid-19 see page 565

- Reflexion, heat reactive memory foam in seat and back
- Seat slider and inflatable lumbar support
- Synchro Plus mechanism with tension adjustment and anti-kick safety feature
- Easy to use ratchet back height adjustment
- 4-way multifunctional, fully adjustable arms with ergonomically shaped, soft polyurethane pads
- Multi adjustable neck and head support
- Seat height 480 - 610mm, width 505mm, depth 470mm
- Popular fabric options shown on next page. Many other fabric options available, please see ranges and price details on pages 561-568



T211521*	Stockholm Chair	£632.98
T211522*	Stockholm Chair with Arms	£703.15
T211523*	Stockholm Chair with Adjustable Headrest	£707.83
T211524*	Stockholm Chair with Adjustable Headrest and Arms	£786.62
T211525	Chrome Base	£41.91

* Please specify fabric colour



Trebuchet Posture Chair

- Very popular back care task chair
- Superior pelvic and spinal support
- Distinctive height adjustable shaped arms
- Black base as standard, polished metal base available POA
- Inflatable lumbar support as standard
- Popular fabric options shown below. Many other fabric options available, please see ranges and price details on pages 561-568



T211531*	Medium Back	£449.47
T211532*	High Back	£499.39
T211533*	High Back with Headrest	£572.00

* Please specify fabric colour

Please see Important Furniture Ordering Information on page 306 before placing your furniture order



Imperial Posture Chair

- The ultimate in back support and cushioning
- Ergonomically shaped back with body tension adjustment
- Independent mechanism and seat slide come as standard
- Option for height and depth adjustable headrest
- Height adjustable arms with gel inserts
- Popular fabric options shown below. Many other fabric options available, please see ranges and price details on pages 561-568

T211541*	Medium Back	£699.77
T211542*	Medium Back with Headrest	£773.37
T211543*	High Back	£745.33
T211544*	High Back with Headrest	£815.42

* Please specify fabric colour

Popular Fabric Colour Options
Standard Fabric - Advantage

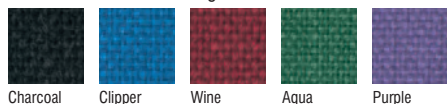

Premium Fabric – Aquarius (add 35% to prices)

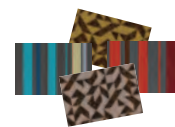

See pages 561-568 for further fabric options



CALL US ON 01527 878348



VISIT WWW.FORWARDPRODUCTS.CO.UK

Vita Skid Base Chair

- This stackable chair is the perfect solution for hospitality, education and commercial environments
- Sturdy polypropylene-fibreglass seat and back with additional comfort foam
- 5 year guarantee
- Popular fabric options shown below. Many other fabric options available, please see ranges and price details on pages 561-568



T210681* Vita Skid Base Chair £138.64

* Please specify fabric colour

Please see Important Furniture Ordering Information on page 306 before placing your furniture order



Catania Chair

- Sleek conference chair with square shaped back
- Robust and durable construction
- Standard frames stack up to four high (cantilever frame non-stacking)
- Silver frame (chrome also available POA)
- 5 year guarantee
- Popular fabric options shown below. Many other fabric options available, please see ranges and price details on pages 561-568



T211721* Side Chair £99.36

T211722* Cantilever Chair £97.25

* Please specify fabric colour

Popular Fabric Colour Options Standard Fabric - Advantage



Premium Fabric – Aquarius (add 35% to prices)

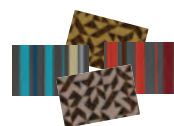

See pages 561-568 for further fabric options



Venice Chair

- Stackable conference chair
- Modern shaped back and deep padded seat
- Durable chrome frame as standard
- 5 year guarantee
- Popular fabric options shown on previous page.
Many other fabric options available, please see ranges and price details on pages 561-568

T211731*	4 Leg Chair	£105.66
T211732*	Cantilever Chair - Upholstered Back	£172.50

* Please specify fabric colour



Please see Important Furniture Ordering Information on page 306 before placing your furniture order

Now available in anti-microbial woven fabric, effective against Covid-19 see page 565

See pages 507-518 for our range of meeting tables

Verona Chair

- Exceedingly comfortable visitors chair
- Waterfall shaped seat and rolled back styling
- Generously proportioned padding
- Stackable
- 5 year guarantee
- Popular fabric options shown on previous page.
Many other fabric options available, please see ranges and price details on pages 561-568

T211741*	Chair	£124.42
T211742*	Chair with Arms	£149.43

* Please specify fabric colour



CALL US ON 01527 878348



VISIT WWW.FORWARDPRODUCTS.CO.UK



15 YEAR
FRAME
GUARANTEE

Valencia Banquet Chair

- Stylish chair for any occasion
- Black frame as standard
- Stack up to 10 high
- Seat height 470mm, seat width 455mm
- 15 year frame guarantee
- Linking option - please ask for details
- Popular fabric options shown below. Many other fabric options available, please see ranges and price details on pages 561-568

T211621* Valencia Banquet Chair £56.03

* Please specify fabric colour

Please see Important Furniture Ordering Information on page 306 before placing your furniture order

Vigo Stacking Chair

- Black welded frame
- Excellent value for money
- Stack up to 5 high
- Seat height 495mm, seat width 495mm
- 15 year frame guarantee
- Popular fabric options shown below. Many other fabric options available, please see ranges and price details on pages 561-568



T211631* Vigo Chair £53.77

T211632* Vigo with Arms £80.66

* Please specify fabric colour

Now available in anti-microbial woven fabric, effective against Covid-19 see page 565

Popular Fabric Colour Options
Standard Fabric - Advantage



Premium Fabric – Aquarius (add 35% to prices)

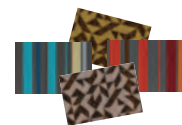

See pages 561-568 for further fabric options



Sevilla Chair

- A collection of multipurpose stacking chairs suitable for conference, meeting and training rooms, public waiting areas, canteens and schools
- Features include comfortable deep foam, three dimensional waterfall seat, plastic feet to eliminate floor scratching with a choice of black or chrome steel frames
- Stackable up to eight high
- Available with a fold-down writing tablet for training rooms
- Seat height 440mm, width 535mm
- Popular fabric options shown below. Many other fabric options available, please call for prices

		1-9	10+
T211651*	Sevilla Chair	£52.06	£46.98
T211653*	Sevilla Chrome Chair	£52.85	£47.68
T211656	Sevilla Canteen Side Chair	£50.70	£48.00

* Please specify fabric colour



T211651



T211653



T211656

Sevilla Chair Fabric Options



Royal Blue Charcoal Claret Black Green Red

Please see Important Furniture Ordering Information on page 306 before placing your furniture order



CALL US ON 01527 878348



VISIT WWW.FORWARDPRODUCTS.CO.UK

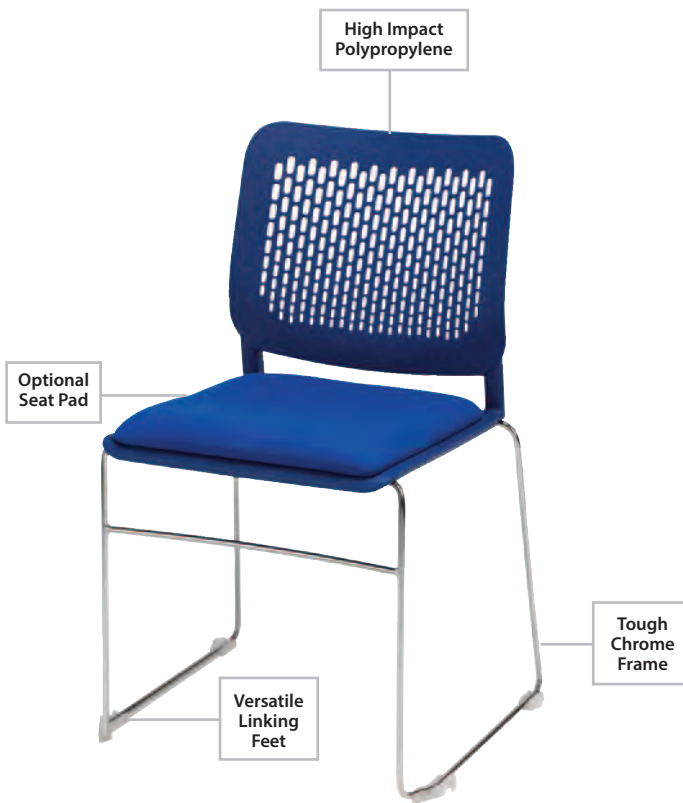

Abele Chair

- Durable multipurpose side chair
- Stackable: 25 un-upholstered, 12 upholstered
- Chrome frame
- Cantilever chairs have integral link
- Chrome chair trolley with lockable castors available
- Chairs also available with arms - POA
- Choice of 7 colours of plastic seat and back: Red, Blue, Black, White, Green, Brown and Grey
- Popular fabric options shown below. Many other fabric options available, please see ranges and price details on pages 561-568
- **Please see Important Furniture Ordering Information on page 306 before placing your furniture order**

T211811*	Cantilever	£99.97
T211812*	Cantilever with Seatpad	£123.73
T211813*	Cantilever with Seat & Back Pad	£140.05
T211814*	4 Leg	£95.66
T211815*	4 Leg with Seatpad	£119.42
T211816*	4 Leg with Seat and Back Pad	£136.30
T211817	Chair Trolley	£198.82

* Please specify fabric and shell colour

 Now available in anti-microbial woven fabric, effective against Covid-19 see page 565



Please Specify:

1. Chair colour
2. Seat and back colours

Shell Colour Options



Popular Fabric Colour Options

Standard Fabric - Advantage



Premium Fabric – Aquarius (add 35% to prices)

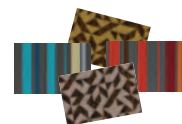
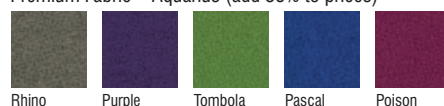

See pages 561-568 for further fabric options





Bianca Chair

- Superior mesh back
- Comfortably padded moulded seat
- Hardwearing chrome frame as standard
- Distinctive curved back and shaped legs
- 5 year guarantee
- Black mesh back as standard, coloured mesh also available, please call for price
- Popular fabric options shown below. Many other fabric options available, please see ranges and price details on pages 561-568
- **Please see Important Furniture Ordering Information on page 306 before placing your furniture order**

T211821*	4 Leg Chair	£188.30
T211822*	Cantilever Chair	£202.66

* Please specify fabric colour

Modena Chair

- Stylish mesh back training and conference chair
- Mesh back available in 11 colours
- Stackable
- Chrome frame as standard
- 5 year guarantee
- Please specify mesh back colour
- Popular fabric options shown below. Many other fabric options available, please see ranges and price details on pages 561-568
- **Please see Important Furniture Ordering Information on page 306 before placing your furniture order**



T211761*	4 Leg Chair	£126.71
T211762*	4 Leg Chair with Arms	£164.33
T211763*	Cantilever Chair	£187.47

* Please specify fabric colour and mesh back colour

Please Specify:

1. Mesh back colour
2. Fabric

Mesh back colour options - Black is standard, all other colours POA

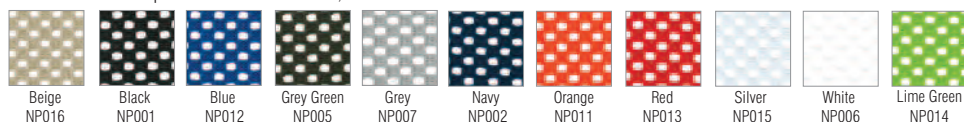

Popular Fabric Colour Options

Standard Fabric - Advantage



Premium Fabric – Aquarius (add 35% to prices)

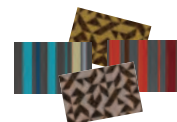
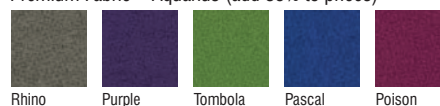

See pages 561-568 for further fabric options



CALL US ON 01527 878348



VISIT WWW.FORWARDPRODUCTS.CO.UK



Abingdon Chair

- Ideal chair for any conference or breakout area
- Soft, upholstered seat and back rest
- Solid wood armrest pads
- Chair linking available
- Wooden, folding writing top also available
- Black leather upholstery

T211891	Abingdon Chair	£133.29
---------	----------------	---------

Please see Important Furniture Ordering Information on page 306 before placing your furniture order

Ascott Chair

- Classic executive conference chair
- Chrome cantilever frame
- Wide, comfortable seat and backrest
- Soft, natural leather upholstered armrests
- Natural split leather faced - Black

T211911	Ascott Chair	£230.64
---------	--------------	---------



Brodsworth Chair

- Slimline and practical leather conference chair
- Chrome frame
- Size: W450 x D430 x H470mm
- Comfortable soft black leather upholstery

T211931	Brodsworth Chair	£147.18
---------	------------------	---------



Abingdon Visitor Chair

- Extra-large, deep cushioned chair for maximum comfort
- Durable, wooden frame with antibacterial lacquer
- 5 year guarantee
- Popular fabric options shown below. Many other fabric options available, please see ranges and price details on pages 561-568

T212571*	Medium Back	£260.93
T212572*	Medium Back With Arms	£290.59
T212573*	High Back	£282.22
T212574*	High Back With Arms	£311.89

* Please specify fabric colour

 Now available in anti-microbial woven fabric, effective against Covid-19 see page 565



Lorenzo Wood Framed Chair

- Durable, wooden frame with antibacterial lacquer
- Stackable 4 high
- 5 year guarantee
- Popular fabric options shown below. Many other fabric options available, please see ranges and price details on pages 561-568



T212561*	Stacking Side Chair	£140.72
T212562*	Arm Chair	£140.72

* Please specify fabric colour

Popular Colour Options
Main Line Plus Fabric

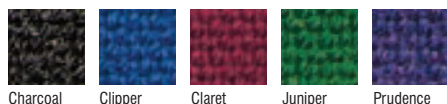

Anti-microbial Just Colour Vinyl (add 15% to prices)

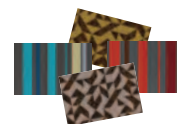

See pages 561-568 for further fabric options



CALL US ON 01527 878348



VISIT WWW.FORWARDPRODUCTS.CO.UK



16

Soft Seating

Modular Seating	453-456
Visitor Seating	457-458
Easy Seating	459-460, 463-469
Tub Chairs	459, 461-462
Bean Bags	470



Now available in anti-microbial woven fabric, effective against Covid-19 see page 262



S210636
W480 x D440 x SH400/440mm

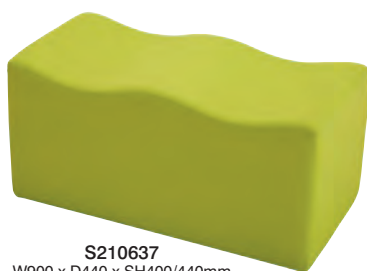

S210637
W900 x D440 x SH400/440mm



S210638
W1350 x D440 x SH400/440mm

Gravity Modular Stool

- A wide range of upholstered stools that work just as well on their own or joined to other stools
- Make each space unique with different stools joined together
- Available in a wide range of shapes and sizes
- Popular fabric options shown on next page. Many other fabric options available, please see ranges and price details on pages 561-568

S210621*	Square	£165.60
S210622*	Perch Square	£185.40
S210623*	Round	£158.40
S210624*	Perch Round	£181.80
S210625*	2 Seater	£216.00
S210626*	3 Seater	£255.60
S210627*	Oval	£201.60
S210628*	Wedge	£169.20
S210629*	Quadrant ¼ Segment	£216.00
S210630*	Tangent ½ Segment	£284.40
S210631*	Tripod	£441.00
S210632*	Octagon	£207.00
S210633*	Arrow ¼ Segment	£208.80
S210634*	Figure of 8	£257.40
S210635*	Opal	£342.00
S210636*	Square Scoop	£187.20
S210637*	2 Seater Scoop	£243.00
S210638*	3 Seater Scoop	£307.80

* Please specify fabric colour





S210621
W400 x D400 x SH440mm



S210622
W400 x D400 x SH820mm



S210623
W400 x D400 x SH440mm



S210624
W400 x D400 x SH820mm



S210625
W800 x D400 x SH440mm



S210626
W1200 x D400 x SH440mm



S210627
W780 x D400 x SH440mm



S210628
W530/400 x D400 x SH440mm

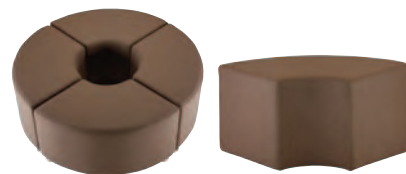

S210629
W860 x D400 x SH440mm

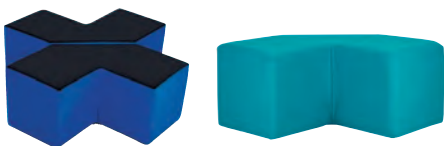

S210630
W790 x D400 x SH440mm



S210631
W980 x D980 x SH440mm

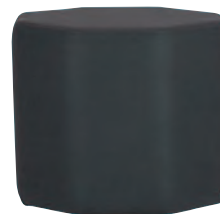

S210632
W470 x D470 x SH440mm

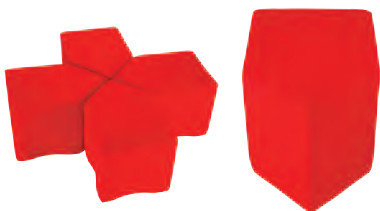

S210633
W790 x D600 x SH440mm



S210634
W980 x D400 x SH440mm



S210635
W1100 x D440 x SH440mm

Popular Colour Options
Main Line Plus Fabric

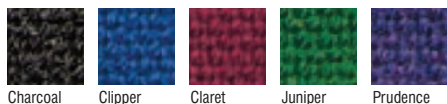

Charcoal Clipper Claret Juniper Prudence

Anti-microbial Just Colour Vinyl (add 15% to prices)



Grape Ocean Blue Citrus Green Cool Blue Deep Rose

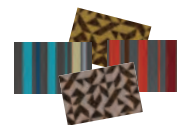

See pages 561-568 for further fabric options



CALL US ON 01527 878348



VISIT WWW.FORWARDPRODUCTS.CO.UK



Swirl Modular Chair

- A flexible range of modular seating with wide range of arm choices
- Fully upholstered modular furniture with deep filled cushions for comfort
- Matching table with oak or glass top
- W560 x D720 x H400mm plus arms
- Popular fabric options shown below. Many other fabric options available, please see ranges and price details on pages 561-568
- **Please see Important Furniture Ordering Information on page 306 before placing your furniture order**

S211111*	Chair - No Arms	£135.30
S211112*	Chair - Left Arm	£173.05
S211113*	Chair - Right Arms	£173.05
S211114*	Armchair	£220.60
S211115*	2 Seater Sofa with Arms	£358.77
S211116*	3 Seater Sofa with Arms	£528.85
S211117*	Corner Unit	£227.22
S211118*	30° Internal Link	£167.21
S211119*	30° Internal Link with Left Arm	£207.95
S211121*	30° Internal Link with Right Arm	£207.95
S211122*	60° External Link	£166.90
S211123*	60° External Link with Left Arm	£206.14
S211124*	60° External Link with Right Arm	£202.52

S211125*	Oak Top Table	£119.37
S211126*	Glass Top Table	£119.37

* Please specify fabric colour

Popular Colour Options

Main Line Plus Fabric

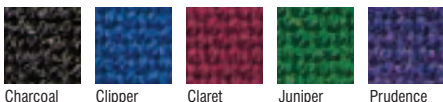

Anti-microbial Just Colour Vinyl (add 15% to prices)

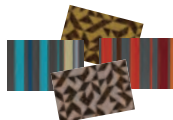

See pages 561-568 for further fabric options





Tangent Modular Chair

- Executive range of modular seating
- Seat height 400mm, seat width 610mm (without arms)
- Bespoke sizes available, please call for details
- Sprung, deep cushioned seats
- Square coffee table with glass top and upholstered sides
- Popular fabric options shown on previous page. Many other fabric options available, please see ranges and price details on pages 561-568
- **Please see Important Furniture Ordering Information on page 306 before placing your furniture order**



Now available in anti-microbial woven fabric, effective against Covid-19 see page 565

Bespoke Sizes Available

S211131*	Chair - No Arms	£199.68
S211132*	Chair - Right Arm	£283.32
S211133*	Chair - Left Arm	£283.32
S211134*	Armchair	£352.71
S211135*	Corner Unit	£261.44
S211136*	Coffee Table	£190.22

* Please specify fabric colour

Torus Modular Chair

- Stylish modular seating
- Chrome feet as standard
- Comprehensive range
- Angled seats also available with arms, please call for details
- Popular fabric options shown on previous page. Many other fabric options available, please see ranges and price details on pages 561-568



S211141*	Chair - No Arms	£210.52
S211142*	Chair - Left Arm	£297.53
S211143*	Chair - Right Arm	£297.53
S211144*	Armchair	£372.54
S211145*	30° Concave Segment	£217.36
S211146*	60° Convex Segment	£217.36

* Please specify fabric colour



CALL US ON 01527 878348



VISIT WWW.FORWARDPRODUCTS.CO.UK



Aruba Modular Chair

- Distinctly designed modular chair
- Looks good in any environment
- 5 year guarantee
- Tables with oak wood top
- Seat height 395mm, seat width 570mm
- Popular fabric options shown below. Many other fabric options available, please see ranges and price details on pages 561-568

S211151*	Chair	£237.67
S211152*	Square Table	£154.06
S211153*	Round Table	£234.26

* Please specify fabric colour



Abingdon Visitor Chair

- Extra-large, deep cushioned chair for maximum comfort
- Durable, wooden frame with antibacterial lacquer
- 5 year guarantee
- Popular fabric options shown below. Many other fabric options available, please see ranges and price details on pages 561-568

T212571*	Medium Back	£260.93
T212572*	Medium Back With Arms	£290.59
T212573*	High Back	£282.22
T212574*	High Back With Arms	£311.89

* Please specify fabric colour



Lorenzo Wood Framed Chair

- Durable, wooden frame with antibacterial lacquer
- Are stackable 4 high
- 5 year guarantee
- Popular fabric options shown below. Many other fabric options available, please see ranges and price details on pages 561-568

T212561*	Stacking Side Chair	£140.72
T212562*	Arm Chair	£140.72

* Please specify fabric colour

Popular Colour Options
Main Line Plus Fabric

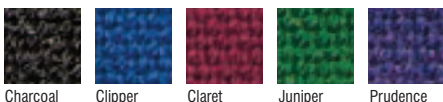

Charcoal

Clipper

Claret

Juniper

Prudence

Anti-microbial Just Colour Vinyl (add 15% to prices)



Grape

Ocean Blue

Citrus Green

Cool Blue

Deep Rose

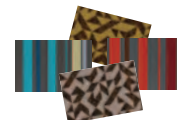

See pages 561-568 for further fabric options



Abingdon Seating

- Excellent for staffrooms, common rooms and heavy use areas
- Extra heavy duty skid base reception chair
- 25mm square tubular frame with 15 year guarantee
- Extra deep foam padding for extra comfort
- Black frame as standard, silver and grey available to order
- Size: W520 x D450 x H410mm
- Popular fabric options shown on previous page. Many other fabric options available, please see ranges and price details on pages 561-568

S211221* Side Chair £123.41

* Please specify fabric colour



Sherborne Seating

- Extremely durable range of chairs
- 25mm square tubular frame with a 15 year guarantee
- Extra deep foam padding
- Black frame as standard, silver and grey available to order
- Size: W520 x D450 x H410mm
- Popular fabric options shown on previous page. Many other fabric options available, please see ranges and price details on pages 561-568

S211211* Side Chair £108.57
S211214* Armchair £153.80

* Please specify fabric colour



 Now available in anti-microbial woven fabric, effective against Covid-19 see page 565





Antol Seating

- Classic attractive tub chair
- Sturdily built chair
- Attractive beech wood or chrome feet
- Deep, fibre-topped seat cushions
- Size: W720 x D510 x H470mm
2 seater width 1240mm
- Popular fabric options shown below. Many other fabric options available, please see ranges and price details on pages 561-568
- **Please see Important Furniture Ordering Information on page 306 before placing your furniture order**

Beech Feet

S211281*	Tub Chair	£394.97
S211282*	2 Seater	£578.97

Chrome Feet

S211283*	Tub Chair	£468.57
S211284*	2 Seater	£659.93

* Please specify fabric colour

Popular Colour Options
Main Line Plus Fabric

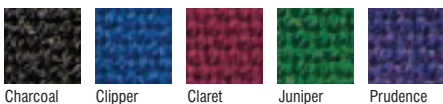

Anti-microbial Just Colour Vinyl (add 15% to prices)

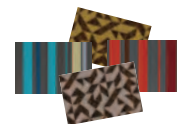

See pages 561-568 for further fabric options



Dominica Seating

- Contemporary designer tub seating
- Armchair and two seater options
- Rectangular glass coffee table W1200 x D600 x H465mm
- Two tone upholstery available, please call for pricing
- Chrome feet as standard
- Popular fabric options shown on previous page. Many other fabric options available, please see ranges and price details on pages 561-568



S211291*	Tub Armchair	£470.40
S211292*	Tub Two Seater	£837.20
S211484	Rectangular Glass Coffee Table	£324.79

* Please specify fabric colour



Please see Important Furniture Ordering Information on page 306 before placing your furniture order



Now available in anti-microbial woven fabric, effective against Covid-19 see page 565



Monaco Seating

- Distinctive modern seating
- Flared arm rests
- Armchair and two seater options
- Complements Dominica seating
- Chrome feet as standard
- Two tone upholstery available, please call for pricing
- Popular fabric options shown on previous page. Many other fabric options available, please see ranges and price details on pages 561-568



S211311*	Armchair	£470.40
S211312*	Two Seater	£837.20
S211483	Square Glass Coffee Table	£268.80

* Please specify fabric colour



CALL US ON 01527 878348



VISIT WWW.FORWARDPRODUCTS.CO.UK



Memphis Tub Chair

- Classy designer tub chair at low prices
- Ideal for any reception area, staff seating area or student areas
- Comfortable deep padded seat
- Stylish Chrome feet
- Available in Black, Red, Navy, Brown or Cream Faux leather

		1-9	10+
S211241*	Memphis Tub Chair	£191.53	£181.95

* Please specify colour

Please see Important Furniture Ordering Information on page 306 before placing your furniture order



Portland Tub Chair

- Stylish tub chair
- Ideal for head teacher's office or reception
- Very modern design
- Sturdy and comfortable
- Black faux leather finish
- Other colours available to order

S211251	Tub Chair Black	£233.25
S211253	Tub Two Seater Black	£344.76



Vancouver Tub Chair

With its deep, comfortable upholstery Vancouver makes the perfect chair for reception areas.

- Built with a robust wooden frame
- 5 year guarantee
- Popular fabric options shown below. Many other fabric options available, please see ranges and price details on pages 561-568

S212261	Tub Chair	£298.79
S212262	Tub Sofa	£523.66
S212263	Round Stool with Chrome Legs & Single Scalloped Cut Out	£191.71
S212264	Round Stool with Chrome Legs & Double Scalloped Cut Out	£207.50



S212263
Single Scalloped



S212264
Double Scalloped

 Now available in anti-microbial woven fabric, effective against Covid-19 see page 565

Please see Important Furniture Ordering Information on page 306 before placing your furniture order



Lexington Tub Chair

- Compact stylish tub chair
- Modern chrome feet
- 2-tone fabric at no extra cost
- Ideal for areas with limited space
- Seat height 440mm, width 650mm overall
- Popular fabric options shown below. Many other fabric options available, please see ranges and price details on pages 561-568

Popular Colour Options
Main Line Plus Fabric

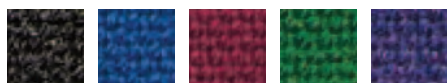

Charcoal Clipper Claret Juniper Prudence

Anti-microbial Just Colour Vinyl (add 15% to prices)

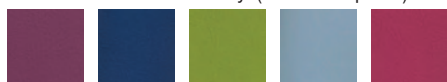

Grape Ocean Blue Citrus Green Cool Blue Deep Rose

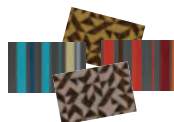

See pages 561-568 for further fabric options

S211271*	Tub Chair	£399.65
----------	-----------	---------

* Please specify fabric colour



CALL US ON 01527 878348



VISIT WWW.FORWARDPRODUCTS.CO.UK



Sorrento Seating

- Classy leather sofa range
- Attractive welded chrome frame
- Size: W580 or 1140 x D560 x H420mm
- Soft black leather upholstery
- **Please see Important Furniture Ordering Information on page 306 before placing your furniture order**



S211321	1 Seater Armchair	£561.16
S211322	2 Seater Sofa	£812.44





Atlanta Seating

- Attractive and popular Atlanta range
- Striking square features
- Deep fill cushions
- One, two and three seater options
- Funky chrome legs
- Popular fabric options shown below. Many other fabric options available, please see ranges and price details on pages 561-568
- **Please see Important Furniture Ordering Information on page 306 before placing your furniture order**



Perfect for reception areas and breakout zones

S211341	1 Seater Armchair	£796.46
S211342	2 Seater Sofa	£1344.06
S211343	3 Seater Sofa	£1452.00

* Please specify fabric colour

Popular Colour Options

Main Line Plus Fabric



Charcoal Clipper Claret Juniper Prudence

Anti-microbial Just Colour Vinyl (add 15% to prices)



Grape Ocean Blue Citrus Green Cool Blue Deep Rose

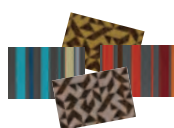

See pages 561-568 for further fabric options

Now available in anti-microbial woven fabric, effective against Covid-19 see page 565



CALL US ON 01527 878348



VISIT WWW.FORWARDPRODUCTS.CO.UK

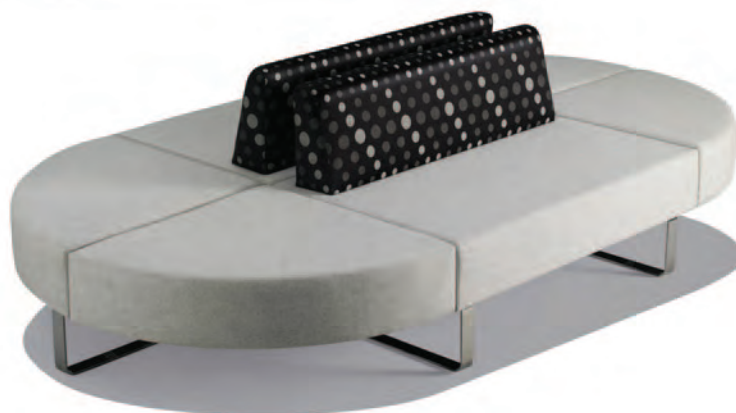
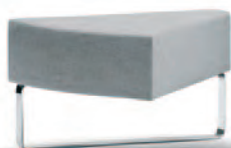

Popular Colour Options

Main Line Plus Fabric



Charcoal Clipper Claret Juniper Prudence

Anti-microbial Just Colour Vinyl (add 15% to prices)



Grape Ocean Blue Citrus Green Cool Blue Deep Rose

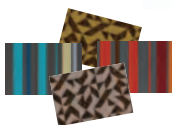

See pages 561-568 for further fabric options

Alfonso Seating

- Fantastic seating concept
- Endlessly flexible arrangements can be created
- Satin silver skid frame
- 5 year guarantee
- Popular fabric options shown below. Many other fabric options available, please see ranges and price details on pages 561-568
- **Please see Important Furniture Ordering Information on page 306 before placing your furniture order**

S211351*	Single Bench	£269.86
S211352*	Single Seat with Back	£362.38
S211353*	Single Seat with Back and Left Hand Arm	£454.91
S211354*	Single Seat with Back and Right Hand Arm	£454.91
S211355*	Double Bench	£402.22
S211356*	Double Seat with Back	£553.86
S211357*	Double Seat with Back and Left Hand Arm	£641.24
S211358*	Double Seat with Back and Right Hand Arm	£641.24
S211359*	45 Degree Connecting Piece	£280.15
S211361*	90 Degree Connecting Piece	£345.68

* Please specify fabric colour



Neapolitan Seating

- Unique tilting design
- Stylish chrome feet
- Well padded seat and back
- Matching armchair and coffee tables
- Two tone fabric available, please call for price
- Popular fabric options shown on previous page.
Many other fabric options available, please see ranges and price details on pages 561-568

S211371*	Chair - No Arms	£226.92
S211372*	Armchair	£309.33
S211373*	Coffee Table Glass Top	£201.84
S211374*	Coffee Table Oak Wood Top	£205.42

* Please specify fabric colour



Please see Important Furniture Ordering Information on page 306 before placing your furniture order

Now available in anti-microbial woven fabric, effective against Covid-19 see page 565



Bugati Seating

- Eye catching and comfortable yet cost effective chair
- Distinctive sturdy build
- Attractive silver feet
- Can be used singularly or side by side
- 5 year guarantee
- Size: W550 x D570mm
- Popular fabric options shown on previous page.
Many other fabric options available, please see ranges and price details on pages 561-568

S211381*	Reception Chair	£325.67
----------	-----------------	---------

* Please specify fabric colour

5 YEAR GUARANTEE



CALL US ON 01527 878348



VISIT WWW.FORWARDPRODUCTS.CO.UK



Brooklyn Seating

- Versatile, quality modular seating system
- Comfortably sprung seats with well cushioned upholstery
- Stylish beech feet as standard, eco chrome feet available as an optional extra
- Ideal for breakout areas, reception areas, staffrooms and common rooms
- Two-tone fabric available, please call for price
- Popular fabric options shown below. Many other fabric options available, please see ranges and price details on pages 561-568
- **Please see Important Furniture Ordering Information on page 306 before placing your furniture order**

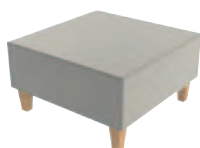

Single Seat Bench

- W730 x D720 x SH420mm

S211561* Single Bench £271.31

* Please specify fabric colour

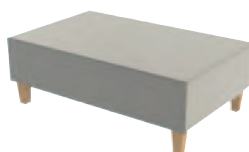

Double Seat Bench

- W1230 x D720 x SH420mm

S211562* Double Bench £375.25

* Please specify fabric colour



Single Seat With Back

- W730 x D720 x SH420mm

S211563* Single Seat With Back £363.79

* Please specify fabric colour



Single Seat With Corner Arm

- W940 x D720 x SH420mm

S211564* Corner Seat Right Arm £451.00

S211565* Corner Seat Left Arm £451.00

* Please specify fabric colour



Two Seater With Back

- W1230 x D720 x SH420mm

S211566* Two Seater With Back £541.72

* Please specify fabric colour



Two Seater With Corner Arm

- W1445 x D720 x SH420mm

S211567* Two Seater Left Arm £661.51

S211568* Two Seater Right Arm £661.51

* Please specify fabric colour



Two Seater Sofa

- W1880 x D720 x SH420mm

S211569* Two Seater Sofa £1005.00

* Please specify fabric colour

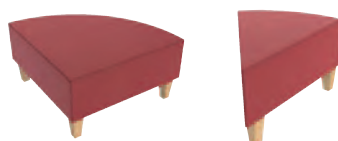

Angled Wedge Benches

- 45 degree wedge: W720 x D720 x SH420mm
- 90 degree wedge: W725 x D725 x SH420mm

S211571* 45° Wedge £275.70

S211572* 90° Wedge £375.25

* Please specify fabric colour



Eco Chrome Foot

Beech Foot
(supplied as standard)

Optional Extras

S211581 Eco Chrome Feet £49.88

S211582 Linking Plate £23.63

Popular Colour Options

Main Line Plus Fabric

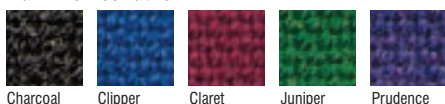

Charcoal

Clipper

Claret

Juniper

Prudence

Anti-microbial Just Colour Vinyl (add 15% to prices)



Grape

Ocean Blue

Citrus Green

Cool Blue

Deep Rose

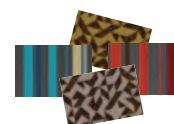

See pages 561-568 for further fabric options





Veneto Seating

- Modern feel with simple, clean lines
- Deep cushioning for extra comfort
- One, two and three seater options
- Popular fabric options shown on previous page. Many other fabric options available, please see ranges and price details on pages 561-568
- **Please see Important Furniture Ordering Information on page 306 before placing your furniture order**



Now available in anti-microbial woven fabric, effective against Covid-19 see page 565

Armchair : W810 x D760 x SH415mm

S211591 £1027.04

2 Seater Sofa: W1410 x D760 x SH415mm

S211592 £1373.12

3 Seater Sofa: W2010 x D760 x SH415mm

S211593 £1723.68



CALL US ON 01527 878348



VISIT WWW.FORWARDPRODUCTS.CO.UK



+ Now available in anti-microbial woven fabric, effective against Covid-19 see page 565



Full Back, Spider Base



Open Back, Spider Base



Open Back, 4 Leg

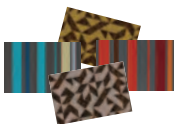

See pages 561-568 for further fabric options



Open Back, Skid Base

Tassimo Chair

- Eyecatching and comfortable breakout seating range
- Full back and open back options
- Open back chairs have curved base and waterfall arms
- Wide range of base options
- Platinum finish bases as standard
- Spider base available in chrome finish, please call for prices
- Popular fabric options shown below. Many other fabric options available, please see ranges and price details on pages 561-568
- **Please see Important Furniture Ordering Information on page 306 before placing your furniture order**

S211651*	Full Back Chair, Spider Base	£357.63
S211653*	Open Back Chair, Spider Base	£374.60
S211654*	Open Back Chair, Four Leg Base	£338.53
S211655*	Open Back Chair, Skid Base	£338.53

* Please specify fabric colour

Popular Colour Options

Main Line Plus Fabric



Charcoal Clipper Claret Juniper Prudence

Anti-microbial Just Colour Vinyl (add 15% to prices)



Grape Ocean Blue Citrus Green Cool Blue Deep Rose





Please see Important Furniture Ordering Information on page 306 before placing your furniture order



Academia Reading Pods

- High back study bean bags
- Perfect for reading and laptop use
- Waterproof and wipe clean
- H1180 x D660mm

S211531 Reading Pods - Fabric £102.17



Perfect for study zones, libraries and breakout areas



Academia Giant Bean Bag

- "Easi-in easi-out" bean bag with plenty of back support
- Waterproof and wipe clean
- High seat ideal for secondary school environments
- W920 x D900mm

S211541 Giant Bean Bag - Fabric £128.45

Academia Giant Floor Cushion

- Versatile giant floor cushion allowing multiple seating positions
- Big enough for students in flat position
- Waterproof and wipe clean fabric finish
- W1400 x L1800mm

S211551 Giant Floor Cushion - Fabric £136.04

Please Specify:
Fabric colour

Fabric Options



CALL US ON 01527 878348



VISIT WWW.FORWARDPRODUCTS.CO.UK



17

Office Furniture

Panel End Desks	473-474
Cantilever Desks	475-476
Executive Desks	477-480
Bench Desking	481-484
Pedestals	485-486
Height Adjustable Desks	487-488
Desk Extensions	489
Pigeon Hole Units	490
Accessories	491-494
Screens	495-498
Storage	499-506
Meeting Tables	507-508
Training Tables	509-511
Flip Top Tables	512
Boardroom Tables	513-518
Coffee Tables	519-522



Sienna Panel End Desks

- For a smart and inexpensive desking solution, choose the Sienna Panel End desk range.
- The 25mm panel legs create a very strong workstation, and also give an extra degree of privacy
- All Sienna furniture is made in the UK and carries a 10 year warranty
- Supplied fully assembled for your convenience



Rectangular 800mm Deep

	W x D x H(mm)	
O223611	800 x 800 x 740	£152.18
O223612	1000 x 800 x 740	£159.43
O223613	1200 x 800 x 740	£166.68
O223614	1400 x 800 x 740	£174.53
O223615	1600 x 800 x 740	£182.38
O223616	1800 x 800 x 740	£191.44
O223617	2000 x 800 x 740	£200.49



Rectangular 600mm Deep

	W x D x H(mm)	
O223621	800 x 600 x 740	£144.94
O223622	1000 x 600 x 740	£150.98
O223623	1200 x 600 x 740	£158.83
O223624	1400 x 600 x 740	£166.07
O223625	1600 x 600 x 740	£173.32
O223626	1800 x 600 x 740	£181.77
O223627	2000 x 600 x 740	£190.83

Top Finishes





Crescent 800/600mm Ends

- Please specify hand (RH shown)

	W x D x H(mm)	
O223631	1200 x 1200 x 740	£193.25
O223632	1400 x 1200 x 740	£201.70
O223633	1600 x 1200 x 740	£213.18
O223634	1800 x 1200 x 740	£224.65
O223635	2000 x 1200 x 740	£242.77



Wave 1000/800mm Ends

- Please specify hand (RH shown)

	W x D x H(mm)	
O223641	1000 x 1000 x 740	£177.55
O223642	1200 x 1000 x 740	£183.59
O223643	1400 x 1000 x 740	£191.44
O223644	1600 x 1000 x 740	£199.29
O223645	1800 x 1000 x 740	£208.35



CALL US ON 01527 878348



VISIT WWW.FORWARDPRODUCTS.CO.UK



Sienna Cantilever Desks

- Looking for robust and inexpensive desks? The Sienna Cantilever range is for you! Available in all popular sizes, and in a wide range of wood finishes, these desks are ideal for educational settings
- All Sienna furniture is made in the UK and carries a 10 year warranty
- Supplied fully assembled for your convenience

Top Finishes



Metalwork Finishes - Silver supplied if not specified

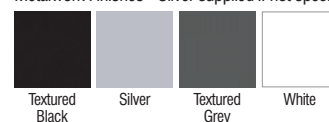

Rectangular 800mm Deep

	W x D x H(mm)	
O223651	800 x 800 x 740	£137.20
O223652	1000 x 800 x 740	£137.20
O223653	1200 x 800 x 740	£141.40
O223654	1400 x 800 x 740	£147.00
O223655	1600 x 800 x 740	£153.30
O223656	1800 x 800 x 740	£166.60



Rectangular 600mm Deep

	W x D x H(mm)	
O223661	800 x 600 x 740	£133.70
O223662	1000 x 600 x 740	£133.70
O223663	1200 x 600 x 740	£137.20
O223664	1400 x 600 x 740	£142.80
O223665	1600 x 600 x 740	£148.40
O223666	1800 x 600 x 740	£161.70



Crescent 800/600mm Ends

- Please specify hand (RH shown)

	W x D x H(mm)	
O223671	1400 x 1200 x 740	£189.70
O223672	1600 x 1200 x 740	£201.60
O223673	1800 x 1200 x 740	£216.30



Wave 1000/800mm Ends

- Please specify hand (RH shown)

	W x D x H(mm)	
O223681	1000 x 1000 x 740	£158.20
O223682	1200 x 1000 x 740	£162.40
O223683	1400 x 1000 x 740	£171.50
O223684	1600 x 1000 x 740	£193.90
O223685	1800 x 1000 x 740	£207.20





Sienna Executive Wire Managed Desks

- The Sienna Executive range brings together a stylish wire-managed frame design with a huge array of top shapes and sizes. Raise the bar with a modern looking office environment!
- Choose from a wide range of stylish wood finishes, and combine with metalwork colour of your choice!
- All Sienna furniture is made in the UK and carries a 10 year warranty
- Supplied fully assembled for your convenience

Rectangular 800mm Deep



W x D x H(mm)

O223691	800 x 800 x 740	£216.49
O223692	1000 x 800 x 740	£222.89
O223693	1200 x 800 x 740	£231.22
O223694	1400 x 800 x 740	£239.55
O223695	1600 x 800 x 740	£247.23
O223696	1800 x 800 x 740	£257.48
O223697	2000 x 800 x 740	£267.09

Rectangular 600mm Deep



W x D x H(mm)

O223711	800 x 600 x 740	£207.52
O223712	1000 x 600 x 740	£215.21
O223713	1200 x 600 x 740	£222.25
O223714	1400 x 600 x 740	£229.94
O223715	1600 x 600 x 740	£238.27
O223716	1800 x 600 x 740	£246.59
O223717	2000 x 600 x 740	£256.84

Top Finishes



Metalwork Finishes - Silver supplied if not specified

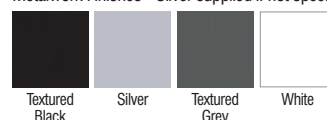

D Ended 800mm Deep

- Please specify hand (RH shown)

	W x D x H(mm)	
O223721	2000 x 800 x 740	£345.23
O223722	2200 x 800 x 740	£360.60



Angular 800 Ends

- Please specify hand (RH shown)

	W x D x H(mm)	
O223731	2000 x 1134 x 740	£377.25
O223732	2200 x 1134 x 740	£395.83



S Shape 800/600mm Ends

- Please specify hand (RH shown)

	W x D x H(mm)	
O223741	1600 x 1200 x 740	£303.60
O223742	1800 x 1200 x 740	£315.77
O223743	2000 x 1200 x 740	£337.54



Bow Front S Shape 800/600mm Ends

- Please specify hand (RH shown)

	W x D x H(mm)	
O223751	1600 x 1400 x 740	£345.87
O223752	1800 x 1400 x 740	£376.61
O223753	2000 x 1400 x 740	£408.00



Compact S Shape 800/600mm Ends

- Please specify hand (RH shown)

	W x D x H(mm)	
O223761	1600 x 1000 x 740	£301.68
O223762	1800 x 1000 x 740	£310.64



Symmetrical 800/800mm Ends

- Please specify hand (RH shown)

	W x D x H(mm)	
O223771	1600 x 1600 x 740	£506.64
O223772	1800 x 1800 x 740	£536.74





Sienna Executive Wire Managed Desks Continued

Crescent 800/600mm Ends

- Please specify hand (RH shown)

	W x D x H(mm)	
O223781	1200 x 1200 x 740	£259.40
O223782	1400 x 1200 x 740	£268.37
O223783	1600 x 1200 x 740	£280.54
O223784	1800 x 1200 x 740	£292.07
O223785	2000 x 1200 x 740	£311.28

Crescent 800/800mm Ends

- Please specify hand (RH shown)

	W x D x H(mm)	
O223791	1200 x 1200 x 740	£267.73
O223792	1400 x 1200 x 740	£276.70
O223793	1600 x 1200 x 740	£289.51
O223794	1800 x 1200 x 740	£302.32
O223795	2000 x 1200 x 740	£322.17

Crescent 600/600mm Ends

- Please specify hand (RH shown)

	W x D x H(mm)	
O223811	1200 x 1200 x 740	£251.08
O223812	1400 x 1200 x 740	£260.04
O223813	1600 x 1200 x 740	£271.57
O223814	1800 x 1200 x 740	£282.46
O223815	2000 x 1200 x 740	£301.68

Wave 1000/800mm Ends

- Please specify hand (RH shown)

	W x D x H(mm)	
O223821	1000 x 1000 x 740	£242.11
O223822	1200 x 1000 x 740	£249.15
O223823	1400 x 1000 x 740	£257.48
O223824	1600 x 1000 x 740	£265.17
O223825	1800 x 1000 x 740	£275.42

Wave 800/600mm Ends

- Please specify hand (RH shown)

	W x D x H(mm)	
O223831	1000 x 800 x 740	£233.14
O223832	1200 x 800 x 740	£239.55
O223833	1400 x 800 x 740	£246.59
O223834	1600 x 800 x 740	£255.56
O223835	1800 x 800 x 740	£263.89

Double Wave 1000mm Ends

- Please specify hand (RH shown)

	W x D x H(mm)	
O223841	1600 x 1000 x 740	£297.19
O223842	1800 x 1000 x 740	£308.08





Bow Fronted 1000mm Deep

- 800 ends

	W x D x H(mm)	
O223851	1200 x 1000 x 740	£280.54
O223852	1400 x 1000 x 740	£287.58
O223853	1600 x 1000 x 740	£297.19
O223854	1800 x 1000 x 740	£308.08



120° Core Unit

	W x D x H(mm)	Ends mm	
O223861	1558 x 970 x 740	600	£416.97
O223862	1905 x 1243 x 740	800	£425.93
O223863	2078 x 1120 x 740	600	£451.55
O223864	2078 x 1293 x 740	800	£482.94



Curved 800mm Ends

	W x D x H(mm)	
O223871	1800 x 950 x 740	£387.50



Top Finishes



Metalwork Finishes - Silver supplied if not specified

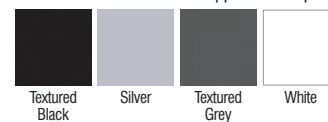

CALL US ON 01527 878348



VISIT WWW.FORWARDPRODUCTS.CO.UK



Sienna Bench Desks

- With clean and unfussy lines, Sienna bench desking creates a professional office environment at affordable prices
- Tops include a scallop for cables and top sizes over 1400mm wide accept return desks on page 483
- All Sienna furniture is made in the UK and carries a 10 year warranty
- Supplied fully assembled for your convenience

Single Bench Starter 800mm Deep

	W x D x H(mm)	
O223881	1000 x 800 x 740	£182.80
O223882	1200 x 800 x 740	£193.20
O223883	1400 x 800 x 740	£209.30
O223884	1600 x 800 x 740	£220.50
O223885	1800 x 800 x 740	£231.70

Single Bench Add-On 800mm Deep

	W x D x H(mm)	
O223891	1000 x 800 x 740	£163.80
O223892	1200 x 800 x 740	£173.60
O223893	1400 x 800 x 740	£188.30
O223894	1600 x 800 x 740	£198.80
O223895	1800 x 800 x 740	£208.60

Double Bench Starter 800mm Deep

	W x D x H(mm)	
O223911	1000 x 1600 x 740	£324.80
O223912	1200 x 1600 x 740	£340.90
O223913	1400 x 1600 x 740	£357.00
O223914	1600 x 1600 x 740	£363.30
O223915	1800 x 1600 x 740	£379.40

Double Bench Add-On 800mm Deep

	W x D x H(mm)	
O223921	1000 x 1600 x 740	£292.60
O223922	1200 x 1600 x 740	£307.30
O223923	1400 x 1600 x 740	£320.60
O223924	1600 x 1600 x 740	£327.60
O223925	1800 x 1600 x 740	£341.50



Single Bench Starter 600mm Deep

	W x D x H(mm)	
O223931	1000 x 600 x 740	£163.80
O223932	1200 x 600 x 740	£182.00
O223933	1400 x 600 x 740	£205.10
O223934	1600 x 600 x 740	£216.30
O223935	1800 x 600 x 740	£226.80



Single Bench Add-On 600mm Deep

	W x D x H(mm)	
O223941	1000 x 600 x 740	£147.00
O223942	1200 x 600 x 740	£163.80
O223943	1400 x 600 x 740	£184.80
O223944	1600 x 600 x 740	£193.90
O223945	1800 x 600 x 740	£205.10



Double Bench Starter 600mm Deep

	W x D x H(mm)	
O223951	1000 x 1200 x 740	£288.40
O223952	1200 x 1200 x 740	£319.90
O223953	1400 x 1200 x 740	£352.80
O223954	1600 x 1200 x 740	£359.10
O223955	1800 x 1200 x 740	£375.20



Double Bench Add-On 600mm Deep

	W x D x H(mm)	
O223961	1000 x 1200 x 740	£260.40
O223962	1200 x 1200 x 740	£287.70
O223963	1400 x 1200 x 740	£317.10
O223964	1600 x 1200 x 740	£322.70
O223965	1800 x 1200 x 740	£337.40



Top Finishes



Metalwork Finishes - Silver supplied if not specified



CALL US ON 01527 878348



VISIT WWW.FORWARDPRODUCTS.CO.UK



1000 x 600mm Bench Desk Return

	W x D x H(mm)	
O223971	1000 x 600 x 740	£151.90

Top Finishes



Beech Classic Ash Light Oak Modern Oak Maple Plain Grey Portofino Cherry Swiss Elm Verade Oak Walnut White

Metalwork Finishes - Silver supplied if not specified

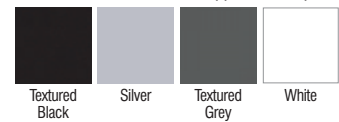

Textured Black Silver Textured Grey White



Sienna Bench Desking Accessories

Bench Desk Extensions

	W x D x H(mm)	
O223981	1200 x 550 x 55	£133.00
O223982	1600 x 550 x 55	£148.40



Mod Panels

- Hooks over frame - no tools needed

	To Fit (mm)	
O223991	1000	£59.50
O223992	1200	£64.40
O223993	1400	£73.50
O223994	1600	£87.50
O223995	1800	£102.20

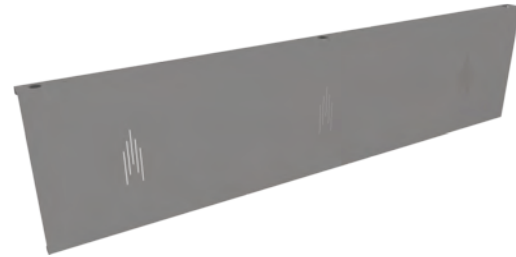

Cable Trays

	To Fit (mm)	
O224011	1000	£28.70
O224012	1200	£30.80
O224013	1400	£32.90
O224014	1600	£35.70
O224015	1800	£39.90



Wire-Managed Insert

- Fits to Add-On legs only

O224021	Insert only	£94.50
---------	-------------	--------



Top Finishes



Metalwork Finishes - Silver supplied if not specified



CALL US ON 01527 878348



VISIT WWW.FORWARDPRODUCTS.CO.UK



Sienna Pedestal Units

- Robust pedestal drawer units in matching wood finishes to the Sienna desking ranges
- All Sienna furniture is made in the UK and carries a 10 year warranty
- Supplied fully assembled for your convenience

Desk High Pedestal

- Locking, 2 Keys

W438 x D800 x H740mm

O224031	4 Drawers	£185.40
O224032	3 Drawers	£185.40
O224033	2 Drawers	£185.40

W438 x D600 x H740mm

O224036	4 Drawers	£166.07
O224037	3 Drawers	£166.07
O224038	2 Drawers	£166.07



Mobile Underdesk Pedestal

- Locking, 2 Keys

W438 x D550 x H635mm

O224041	4 Drawers	£168.49
O224042	3 Drawers	£168.49
O224043	2 Drawers	£168.49

W438 x D514 x H635mm

O224046	4 Drawers	£168.49
O224047	3 Drawers	£168.49
O224048	2 Drawers	£168.49



Small Mobile Pedestal

- Locking, 2 Keys

W438 x D605 x H595mm

O224111	3 Drawers	£140.10
O224112	2 Drawers	£140.10

Wood Finishes



Drawer Options

2 Drawer



2 Deep Filing Drawers
NB: Files hang front to back

3 Drawer



2 Shallow Drawers 1 Deep
NB: Files hang front to back

4 Drawer



4 Shallow Drawers

Straight Pedestal Extension

- Locking, 2 Keys
- Adjustable feet
- Supplied assembled
- Price includes pedestal and extension top

W1000 x D800 x H740mm

O224071	4 Drawers	£224.65
O224072	3 Drawers	£224.65
O224073	2 Drawers	£224.65

W1000 x D600 x H740mm

O224076	4 Drawers	£197.48
O224077	3 Drawers	£197.48
O224078	2 Drawers	£197.48



Curved Pedestal Extension

- Locking, 2 Keys
- Adjustable feet
- Supplied assembled
- Price includes pedestal and extension top

W1000 x D800 x H740mm

O224091	4 Drawers	£247.00
O224092	3 Drawers	£247.00
O224093	2 Drawers	£247.00



Fixed Pedestal

- Locking, 2 Keys

W426 x D577 x H505mm

O224061	3 Drawers	£109.31
O224062	2 Drawers	£109.31

W426 x D520 x H505mm

O224063	3 Drawers	£109.31
O224064	2 Drawers	£109.31





Sienna Height Adjustable Desks

Sienna height adjustable desks are made in Europe with a minimalistic design and a reliable dual motor mechanism. Our three stage lifting column allows for an incredibly long stroke to cater for the smallest to the tallest user and with a 38mm per second movement you can get from sitting to standing in seconds.



Sienna Height Adjustable Desks

- 3 stage dual LINAK motor
- 670 - 1270mm height adjustment
- 5 year parts guarantee on electric components
- 10 years parts on wooden components
- Accepts standard screens with C clamp
- Only small pedestals will fit desk at lowest height
- High underdesk pedestals can fit providing desk is not lowered to lowest setting (or ideally programmed through software)

	W x D(mm)	
O224121	1000 x 800	£672.53
O224122	1200 x 800	£689.18
O224123	1400 x 800	£706.47
O224124	1600 x 800	£723.77
O224125	1800 x 800	£741.06

	W x D(mm)	
O224131	1000 x 600	£648.19
O224132	1200 x 600	£665.48
O224133	1400 x 600	£682.77
O224134	1600 x 600	£700.07
O224135	1800 x 600	£717.36



Single Wire Snake

- Tidy up your Sienna height adjustable desk with a wire snake
- Floor to desktop - for single desks only

O224141	£59.57
---------	--------



Metal Cable Tray

- Fixes to underside of desk to organise and tidy away your cables

	To Fit (mm)	
O224151	1000	£26.26
O224152	1200	£28.18
O224153	1400	£30.10
O224154	1600	£32.67
O224155	1800	£36.51

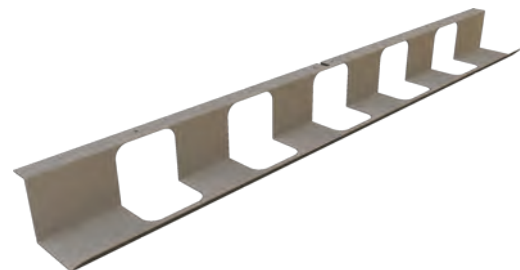

Top Finishes



Frame Colours



CALL US ON 01527 878348



VISIT WWW.FORWARDPRODUCTS.CO.UK

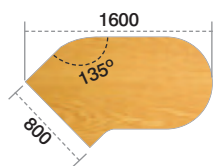

Sienna Meeting End Extension

- 60mm Tubular legs or Trumpet base
- Please specify left or right hand left hand shown on image, right hand on illustration

	W x D x H(mm)	Leg Style	
O224161	1600 x 945 x 740	Tubular	£315.77
O224162	1600 x 945 x 740	Trumpet	£350.99

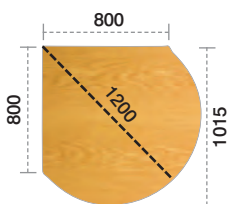

Sienna Teardrop Desk Extension

- 60mm tubular legs or trumpet base

	W x D x H(mm)	Leg Style	
O224171	1200 x 1015 x 740	Tubular	£304.88
O224172	1200 x 1015 x 740	Trumpet	£345.23

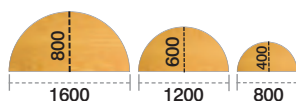

Sienna Radial Desk Extension

- 60mm Tubular legs

	W x D x H(mm)	
O224181	1600 x 800 x 740	£264.53
O224182	1200 x 600 x 740	£247.23
O224183	800 x 400 x 740	£219.05

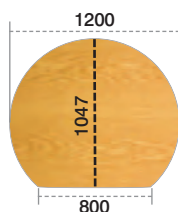

Sienna Radial Desk Extension

- 60mm Tubular legs or Trumpet base

	W x D x H(mm)	Leg Style	
O224191	1200 x 1047 x 740	Tubular	£304.88
O224192	1200 x 1047 x 740	Trumpet	£345.23

Top Finishes



Metalwork Finishes - Silver supplied if not specified

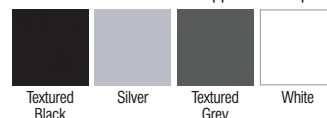



Windsor Pigeonhole Units

Pigeonhole units are still a very popular solution for storing and organising documents

- Manufactured from grade E1 melamine-faced high density particleboard
- 25mm top and base
- 18mm sides, shelves and doors
- Polypropylene feet
- The feet at the front of each unit have a height levelling mechanism built-in
- Compartment sizes 230 x 363 x 120mm high

	W x D x H(mm)	Compartments	
O224200	538 x 400 x 1900	20	£438.16
O224201	786 x 400 x 1900	30	£528.05
O224202	1034 x 400 x 1900	40	£585.80
O224203	1285 x 400 x 1900	50	£652.74



O224200



O224201



O224202



O224203

Wood Finishes

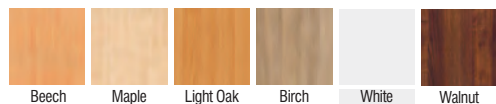

Beech

Maple

Light Oak

Birch

White

Walnut



CALL US ON 01527 878348



VISIT WWW.FORWARDPRODUCTS.CO.UK

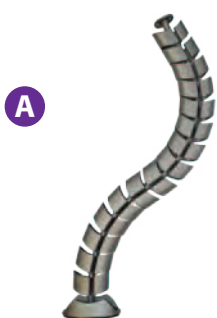

A

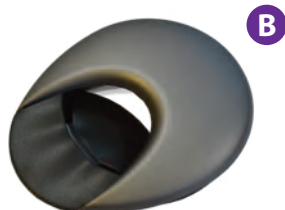

B



C

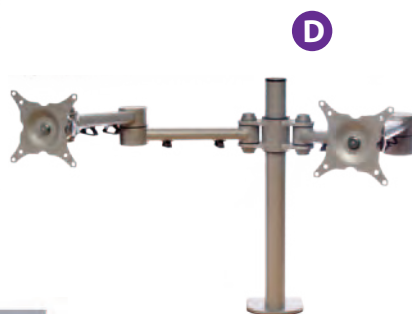

D



E



F



G



H

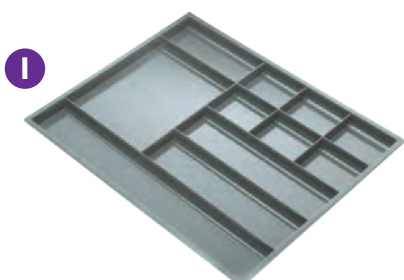

I

A. Cable Spine

- Fixes to underside of any top
- Silver

O224211		£40.99
---------	--	--------

B. 80mm Cable Port

O224221	Grey	£4.48
O224222	Silver	£4.48

C. Single Monitor Arm

- Supplied with both through-desk & edge C-clamp fittings
- Vesa plate included
- Fully adjustable

O224231		£92.87
---------	--	--------

D. Double Monitor Arm

- Supplied with both through-desk & edge C-clamp fittings
- Vesa plate included
- Fully adjustable

O224241		£188.31
---------	--	---------

E. CPU Holder (Strapped)

- Please state which desk range the holder is being attached to
- Also suitable for bench desking

O224251		£57.00
---------	--	--------

F. CPU Holder (Adjustable)

- Please state which desk range the holder is being attached to
- Also suitable for bench desking

O224261		£108.24
---------	--	---------

G. Mobile Adjustable CPU Holder

O224262		£60.85
---------	--	--------

H. Table Connectors

- Supplied in a connecting pair (as per image)

O224271		£10.25
---------	--	--------

I. Pen Tray

- To fit in any 438mm width pedestal
- O224281 is a factory fitted option
- O224291 is a drop-in tray (cannot fit in top drawers due to locking mechanism)

O224281	Factory Fitted	£39.71
O224291	Drop-in	£12.81



A. 4 Gang Power Socket

- Unswitched
- Includes 3m power cable
- Spare fuse in every socket

O224311 £35.87



A

B. Desktop Power Module

- Includes 3m power cable
- Spare fuse in every socket
- 2 Power 2 USB charge 1 Switch

O224321 £140.27



B

C. Flip Power Module

- Includes 3m power cable
- Spare fuse in every socket
- 2 Power 2 Data 1 Switch
- Factory-fitted includes fitting module into table of your choice

O224331 £162.05

O224332 Factory-fitted £206.88



C

D. Cable Access Module

- Available in black, white and silver
- Single or double option available.
- Factory-fitted includes fitting module into table of your choice
- Other sizes available

O224341 Single Option £42.27

O224342 Factory-fitted £87.11

O224343 Double Option £47.40

O224344 Factory-fitted £92.23

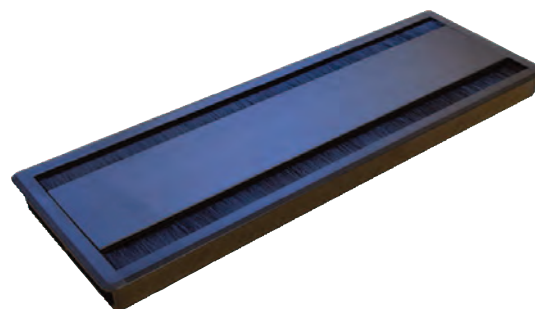

D

E. Metal Cable Tray

- Please state which desk range the tray is fitting on to

	To Fit (mm)	
O224361	600	£23.06
O224362	800	£24.34
O224363	1000	£26.26
O224364	1200	£28.18
O224365	1400	£30.10
O224366	1600	£32.67
O224367	1800	£36.51
O224368	2000	£41.63

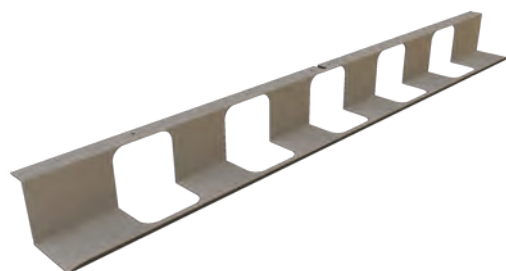

E



CALL US ON 01527 878348



VISIT WWW.FORWARDPRODUCTS.CO.UK

A



A. Arc - Wireless Charger

- Arc H LD 10 Watts of wireless charging power
- Includes 1.5m power cable
- Supplied loose, fixes to underside of any top
- Silver

O224371

£55.08

B



B. Powerdot 80mm Grommet

- Supplied loose, slots into any desk with a cable grommet
- Can be fitted to units without cable grommets, please call for price

O224391 1 x UK Fused Socket £44.19

O224392 1 x TUF (A+C) USB Fast Charging £90.31

O224393 1 x TUF (A+C) USB Fast Charging, Data £102.48

C

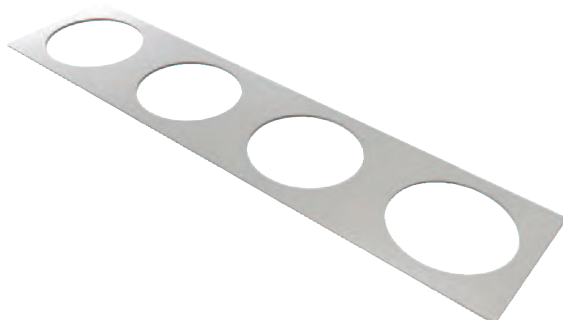

C. Powerdot Frame

- Metal frame for power dot, available in black, white and silver

O224411 2 Hole Frame £33.31

O224412 4 Hole Frame £52.52

D



D. Podium Socket Box

- 2 x UK fused Socket
- 1 x TUF-R (A+C) USB Fast Charging
- 2 x RJ45 Outlet with CAT 5E or CAT 6 data
- Based on Stainless Steel, Simple clamping kit
- Factory-fitted into furniture unit of your choice, please call to confirm positioning required

O224431

£376.69

E



E. Puma Socket Box

- 2 or 3 gang option
- 2 x UK fused sockets, 1 x TUF-R (A+C)
- USB Fast Charging
- Factory-fitted into furniture unit of your choice, please call to confirm positioning required

O224441

£149.24



A. Pluto Socket Box

- 2 x UK fused Socket
- 1 x TUF-R (A+C) USB Fast Charging
- For 80mm aperture or rubber feet with side exit cable
- Available in various colours
- Supplied loose, slots into any desk with a cable grommet
- Can be fitted to units without cable grommets, please call for price

O224451 £206.24



A

B. Pluto Data Cartridge Socket Box

- 2 x RJ45 outlet
- 1 x HDMI
- Requires Pluto main module to work
- Supplied loose, slots into any desk with a cable grommet
- Can be fitted to units without cable grommets, please call for price

O224461 £218.41



B

C. Phase Socket Box

- 1 x UK fused Socket
- 1 x TUF-R (A+C) USB Fast Charging
- Screw down bracket
- In white or black
- Supplied loose, fixes to underside of any top

O224471 £182.54



C

D. Pandora Socket Box

- 2 x UK fused sockets
- 1 x TUF-R (A+C) USB Fast Charging
- Inlay frame – Black with stainless steel bezel
- Module flips to hide sockets and gives a smooth flat finish, available in a number of finishes
- Supplied loose, slots into any desk with a cable grommet
- Can be fitted to units without cable grommets, please call for price

O224481 £262.61



D

E. Prism Socket Box

- 2 or 4 x UK fused socket
- 2 or 4 x RJ45 Outlet CAT 5e or CAT 6
- Black socket fascia's endcaps and flexilip natural anodised internal and external extrusion
- Factory-fitted into furniture unit of your choice, please call to confirm positioning required

O224491 2 or 4 x UK fused Socket £247.95

O224492 2 or 4 x RJ45 Outlet CAT 5e or CAT6 £362.60



E

F. Nilla Lamp

- 1100 / 880 / 660 / 440 / 220 Lux
- 95 Lm/W
- 4 hour eco-timer
- 1 x USB-charger (5v, 2.1 A)
- 220-240V, DC 12V 2A, Max 24W
- 7W power consumption (Energy A rating)
- LED lamp with USB charger
- Adjustable brightness with eco timer

O224511 £144.11



F



CALL US ON 01527 878348



VISIT WWW.FORWARDPRODUCTS.CO.UK



Floorstanding Screens

- For noise reduction and privacy, floor standing screens come in a variety of heights and widths.
- Choose linking screens if you need to separate larger areas with more than just one screen.
- Please select code from grid that combines the required width and height

Popular Colour Options
Standard Fabric - Cara

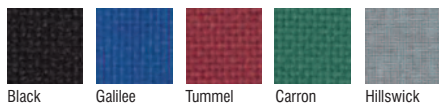

Black Galilee Tummel Carron Hillswick

Premium Fabric - Lucia (add 10% to prices)



Madura Campeche Calypso Bluebell Solano Mauve

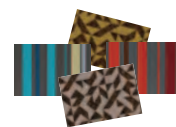

See pages 569-570 for further fabric options



Floorstanding Screens 1000, 1100 & 1200mm High

- Includes T feet as standard
- Please select code from grid that combines the required width and height

Width	Height 1000mm	Height 1100mm	Height 1200mm	
1000mm	O224521	O224531	O224541	£181.17
1100mm	O224522	O224532	O224542	£188.42
1200mm	O224523	O224533	O224543	£195.66
1300mm	O224524	O224534	O224544	£202.91
1400mm	O224525	O224535	O224545	£210.16
1500mm	O224526	O224536	O224546	£217.40
1600mm	O224527	O224537	O224547	£224.65
1700mm	O224528	O224538	O224548	£231.90
1800mm	O224529	O224539	O224549	£239.14

Floorstanding Screens 1300, 1400 & 1500mm High

- Includes T feet as standard
- Please select code from grid that combines the required width and height

Width	Height 1300mm	Height 1400mm	Height 1500mm	
1000mm	O224551	O224561	O224571	£210.16
1100mm	O224552	O224562	O224572	£217.40
1200mm	O224553	O224563	O224573	£224.65
1300mm	O224554	O224564	O224574	£231.90
1400mm	O224555	O224565	O224575	£239.14
1500mm	O224556	O224566	O224576	£246.39
1600mm	O224557	O224567	O224577	£253.64
1700mm	O224558	O224568	O224578	£260.88
1800mm	O224559	O224569	O224579	£268.13

Floorstanding Screens 1600, 1700 & 1800mm High

- Includes T feet as standard
- Please select code from grid that combines the required width and height

Width	Height 1600mm	Height 1700mm	Height 1800mm	
1000mm	O224581	O224591	O224611	£231.90
1100mm	O224582	O224592	O224612	£239.14
1200mm	O224583	O224593	O224613	£246.39
1300mm	O224584	O224594	O224614	£253.64
1400mm	O224585	O224595	O224615	£260.88
1500mm	O224586	O224596	O224616	£268.13
1600mm	O224587	O224597	O224617	£282.63
1700mm	O224588	-	-	£289.87
1800mm	O224589	-	-	£299.53

Linking Screens 1000, 1100 & 1200mm High

- Includes T feet as standard
- Please select code from grid that combines the required width and height

Width	Height 1000mm	Height 1100mm	Height 1200mm	
1000mm	O224521L	O224531L	O224541L	£202.31
1100mm	O224522L	O224532L	O224542L	£209.55
1200mm	O224523L	O224533L	O224543L	£216.80
1300mm	O224524L	O224534L	O224544L	£224.05
1400mm	O224525L	O224535L	O224545L	£231.29
1500mm	O224526L	O224536L	O224546L	£238.54
1600mm	O224527L	O224537L	O224547L	£245.79
1700mm	O224528L	O224538L	O224548L	£253.03
1800mm	O224529L	O224539L	O224549L	£260.28

Linking Screens 1300, 1400 & 1500mm High

- Includes T feet as standard
- Please select code from grid that combines the required width and height

Width	Height 1300mm	Height 1400mm	Height 1500mm	
1000mm	O224551L	O224561L	O224571L	£233.71
1100mm	O224552L	O224562L	O224572L	£240.96
1200mm	O224553L	O224563L	O224573L	£248.20
1300mm	O224554L	O224564L	O224574L	£255.45
1400mm	O224555L	O224565L	O224575L	£262.70
1500mm	O224556L	O224566L	O224576L	£269.94
1600mm	O224557L	O224567L	O224577L	£277.19
1700mm	O224558L	O224568L	O224578L	£284.44
1800mm	O224559L	O224569L	O224579L	£291.68

Linking Screens 1600, 1700 & 1800mm High

- Includes T feet as standard
- Please select code from grid that combines the required width and height

Width	Height 1600mm	Height 1700mm	Height 1800mm	
1000mm	O224581L	O224591L	O224611L	£257.87
1100mm	O224582L	O224592L	O224612L	£265.11
1200mm	O224583L	O224593L	O224613L	£272.36
1300mm	O224584L	O224594L	O224614L	£279.61
1400mm	O224585L	O224595L	O224615L	£286.85
1500mm	O224586L	O224596L	O224616L	£294.10
1600mm	O224587L	O224597L	O224617L	£308.59
1700mm	O224588L	-	-	£315.84
1800mm	O224589L	-	-	£325.50



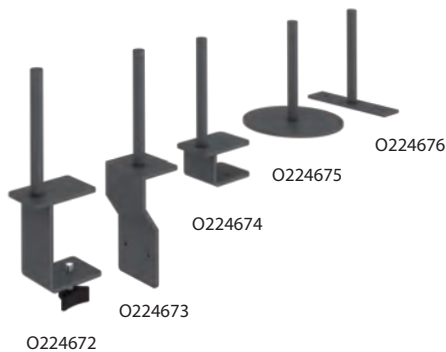

Standard Desktop Screens

- Available in a wide range of sizes and finishes.
- Supplied non-linking as standard.
- Linking option available for additional £45 + VAT, please specify if required.

A. Rectangular Desktop Screen

- Available in 300mm, 380mm & 480mm heights - please specify when ordering
- Supplied with standard C clamp brackets, see below for other clamp options available for an extra cost

	Width(mm)	
O224631	800	£73.66
O224632	1000	£74.94
O224633	1100	£78.14
O224634	1200	£79.42
O224635	1400	£83.27
O224636	1500	£86.47
O224637	1600	£89.67
O224638	1638	£89.67
O224639	1800	£92.23
O224641	2000	£101.20

B. Shaped Desktop Screen

- Available in 300mm, 380mm & 480mm heights - please specify when ordering
- Supplied with standard C clamp brackets, see below for other clamp options available for an extra cost

	Width(mm)	
O224651*	800	£79.42
O224652*	1000	£84.55
O224653*	1100	£86.47
O224654*	1200	£88.39
O224655*	1400	£91.59
O224656*	1500	£94.79
O224657*	1600	£96.62
O224658*	1638	£96.72
O224659*	1800	£101.84
O224661*	2000	£109.53

- Please specify Arc(A), Curved(C), Wave(W)

C. Screen Clamps

- Individual Single Clamp (as shown)

O224672	Over-Leg	£11.53
O224673	Panel End	£11.53
O224674	End	£11.53
O224675	Circular	£11.53
O224676	T	£11.53

Popular Colour Options
Standard Fabric - Cara

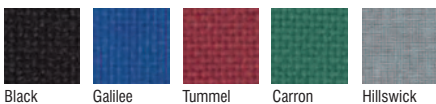

Premium Fabric - Lucia (add 10% to prices)

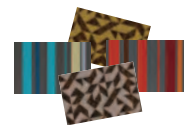
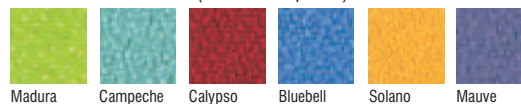

See pages 569-570 for further fabric options



A. Premium Aluminium Desktop Screen

- Premium desktop screens with an aluminium System Surround that accepts the below accessories.
- Non-linking, non-pinnable
- Available in 300mm, 380mm and 480mm high at the same price - supplied 480mm high if not specified

	Width(mm)	
O224681	800	£99.92
O224682	1000	£105.04
O224683	1100	£107.60
O224684	1200	£110.17
O224685	1400	£113.37
O224686	1500	£117.85
O224687	1600	£121.70
O224688	1638	£121.70
O224689	1800	£124.90
O224691	2000	£136.43



Popular Colour Options

Standard Fabric - Cara



Black Gaillee Tummel Carron Hillswick

Premium Fabric - Lucia (add 10% to prices)

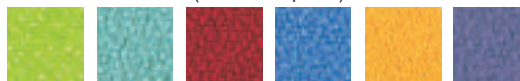

Madura Campeche Calypso Bluebell Solano Mauve

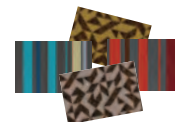

See pages 569-570 for further fabric options

B. Single Toolbar Monitor Arm

- Available in silver only

O224711	£121.70
---------	---------



C. Single Toolbar Monitor Arm

- Available in Silver only

O224721	£67.25
---------	--------



D. Metal Toolbar A4 Paper Tray

- Landscape
- Available in Silver only

O224731	£39.07
---------	--------

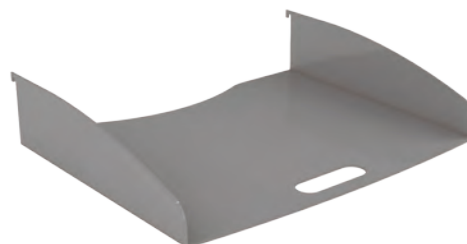

Sienna storage units are made in the UK with a 10 year warranty and are supplied fully assembled



Base Unit

- Locking, 2 keys
- 1 Adjustable shelf
- Adjustable feet

	W x D x H(mm)	
O224741	800 x 600 x 740	£234.42
O224742	1000 x 600 x 740	£254.28
O224743*	1200 x 600 x 740	£285.66

* These units have a central support

Glass Door Base Unit

- 1 Adjustable shelf
- Adjustable feet

	W x D x H(mm)	
O224751	800 x 600 x 740	£373.41
O224752	1000 x 600 x 740	£408.64
O224753*	1200 x 600 x 740	£447.07

* These units have a central support

Sliding Door Base Unit

- Locking, 2 keys
- 1 Adjustable shelf

	W x D x H(mm)	
O224761	800 x 600 x 740	£288.87
O224762	1000 x 600 x 740	£331.14
O224763*	1200 x 600 x 740	£367.01
O224764*	1600 x 600 x 740	£452.83

* These units have a central support

Credenza

- Locking, 2 keys
- Adjustable feet
- Unit has centre support
- O224771 is supplied with adjustable shelf
- O224772 is supplied with adjustable shelf on one side and fridge on other side (includes ventilation holes)
- Dimensions W1200 x D600 x H740mm

O224771	Credenza with Shelf	£304.88
O224772	Credenza with Shelf & Fridge	£627.05

Wood Finishes



Side Filer

- Locking, 2 keys
- Accepts foolscap files
- Sideways filing

	W x D x H(mm)	
O224781	800 x 600 x 740	£479.09



Desk High Tambour

- Accommodates 2 rows of A4 filing
- Locking, 2 keys
- 1 Adjustable shelf
- Hidden adjustable feet
- Silver tambour doors

	W x D x H(mm)	
O224791	800 x 600 x 740	£429.78



90° Desk High Tambour

- Accommodates 2 rows of A4 filing
- Locking, 2 keys
- 1 Fixed shelf
- Hidden adjustable feet
- Silver tambour doors

	W x D x H(mm)	
O224811	800 x 800 x 740	£466.92



Small Sideboard Unit

- Locking, 2 Keys
- 1 Adjustable shelf, adjustable feet
- Drawers determine hand (RH shown)
- 3 drawer shown
- Please specify hand required when ordering

	W x D x H(mm)		
O224821	1200 x 600 x 740	Open	£327.30
O224822	1200 x 600 x 740	2 Drawer	£421.45
O224823	1200 x 600 x 740	3 Drawer	£421.45
O224824	1200 x 600 x 740	4 Drawer	£421.45



Sideboard Unit

- Locking, 2 keys
- 1 Adjustable shelf (each side)
- Adjustable feet

	W x D x H(mm)		
O224831	1600 x 600 x 740	Open	£527.77
O224832	1600 x 600 x 740	2 Drawer	£620.64
O224833	1600 x 600 x 740	3 Drawer	£620.64
O224834	1600 x 600 x 740	4 Drawer	£620.64



Sienna storage units are made in the UK with a 10 year warranty and are supplied fully assembled



Top Unit

- Units have a flush base allowing for 2x lever arch files to fit

	W x D x H(mm)	Adjustable Shelves	
O224841	800 x 410 x 740	1	£127.46
O224842	800 x 410 x 1060	2	£147.96
O224843*	1200 x 410 x 740	1	£166.53
O224844*	1600 x 410 x 740	1	£185.75

* These units have a central support

Sliding Door Glazed Top Unit

- Optional extra lock for doors

	W x D x H(mm)	Adjustable Shelves	
O224851	800 x 410 x 740	1	£285.66
O224852	800 x 410 x 1060	2	£313.85
O224853	Lock		£27.54

Glass Door Top Unit

- Non-locking

	W x D x H(mm)	Adjustable Shelves	
O224861	800 x 410 x 740	1	£346.51
O224862	800 x 410 x 1060	2	£411.20
O224863*	1200 x 410 x 740		£430.42

* These units have a central support

90° Desk High Bookcase

- 25mm top & shelves
- 1 Fixed Shelf
- Adjustable Feet

	W x D x H(mm)	End	
O224871	600 x 600 x 740	600	£242.75
O224872	800 x 800 x 740	800	£260.04

Wood Finishes



Document Sorter

- 25mm top & shelves
- Compartment size 240W x 190H

	W x D x H(mm)	
O224881	800 x 332 x 1102	£324.09



Multi Combi Unit

- Right hand shown (position of cupboard determines hand)
- Locking, 2 Keys
- Unit supplied with sliding glide feet
- Silver tambour doors

	W x D x H(mm)	
O224891	650 x 800 x 1200	£817.28



Desktop Overhead Tambour

- Locking
- Frame height clearance 505mm
- Accommodates A4 box files
- Silver tambour doors

	W x D x H(mm)	
O224911	1600 x 465 x 1010	£522.65
O224912	1800 x 465 x 1010	£554.67



Glass 2 Door Cupboard

- Non-locking

	W x D x H(mm)	Adjustable Shelves	
O224921	800 x 410 x 740	1	£346.51
O224922	800 x 410 x 1200	2	£507.92
O224923	800 x 410 x 1600	3	£586.06
O224924	800 x 410 x 1800	3	£618.08
O224925	800 x 410 x 2000	4	£653.95



Sienna storage units are made in the UK with a 10 year warranty and are supplied fully assembled



Desk High Mobile Storage Unit

- Single Sided
- Unit comes on castors
- 2 Adjustable shelves

	W x D x H(mm)	
O225011	1000 x 410 x 740	£273.49
O225012*	1200 x 410 x 740	£293.35
O225013*	1600 x 410 x 740	£331.14

* These units have a central support

Desk High Mobile Storage Unit

- Double Sided
- Unit comes on castors
- 4 Adjustable shelves

	W x D x H(mm)	
O225021	1000 x 600 x 740	£367.01
O225022*	1200 x 600 x 740	£441.30
O225023*	1600 x 600 x 740	£587.98

* These units have a central support

Under Desk Storage Mobile Unit

- Please specify left or right handed
- Left hand shown (position of cupboard determines hand)

	W x D x H(mm)	
O225031	1200 x 400 x 620	£464.36
O225032	1600 x 400 x 620	£500.87

Under Desk Mobile Storage Unit

- Single Sided
- 25mm top & shelves
- Unit comes on castors
- 2 Adjustable shelves

	W x D x H(mm)	
O225041	1000 x 410 x 620	£297.83
O225042*	1200 x 410 x 620	£356.76
O225043*	1600 x 410 x 620	£476.53

* These units have a central support

Under Desk Mobile Storage Unit

- Double Sided
- 25mm top & shelves
- Unit comes on castors
- 4 Adjustable shelves

	W x D x H(mm)	
O225051	1000 x 600 x 620	£348.43
O225052*	1200 x 600 x 620	£417.61
O225053*	1600 x 600 x 620	£555.95

* These units have a central support



Bookcase

	W x D x H(mm)	Adjustable Shelves	
O225061	800 x 410 x 2000	4	£252.36
O225062	800 x 410 x 1800	3	£228.66
O225063	800 x 410 x 1600	3	£211.37
O225064	800 x 410 x 1200	2	£152.44
O225065	800 x 410 x 1000	2	£134.51
O225066	800 x 410 x 740	1	£127.46
O225067*	800 x 410 x 740	1	£127.46
O225068	1000 x 410 x 2000	4	£294.63
O225069	1000 x 410 x 1800	3	£270.29
O225071	1000 x 410 x 1600	3	£247.23
O225072	1000 x 410 x 1200	2	£183.18
O225073	1000 x 410 x 1000	2	£160.13
O225074	1000 x 410 x 740	1	£154.36
O225075*	1000 x 410 x 740	1	£154.36

*Supplied with shallow base to allow for 2 rows of lever arch files



2 Door Cupboard

- Locking, 2 Keys

	W x D x H(mm)	Adjustable Shelves	
O225081	800 x 410 x 2000	4	£399.67
O225082	800 x 410 x 1800	3	£371.49
O225083	800 x 410 x 1600	3	£341.39
O225084	800 x 410 x 1200	2	£281.18
O225085	800 x 410 x 1000	2	£252.36
O225086	800 x 410 x 740	1	£218.41
O225087*	800 x 410 x 740	1	£218.41
O225088	1000 x 410 x 2000	4	£463.08
O225089	1000 x 410 x 1800	3	£426.57
O225091	1000 x 410 x 1600	3	£391.35
O225092	1000 x 410 x 1200	2	£319.61
O225093	1000 x 410 x 1000	2	£282.46
O225094	1000 x 410 x 740	1	£247.23
O225095*	1000 x 410 x 740	1	£247.23

*Supplied with shallow base to allow for 2 rows of lever arch files



Filing Cabinet

- 25mm top
- Supplied assembled
- Locking, 2 Keys
- Anti-tilt mechanism
- 100% drawer opening
- 15kg safe hanging weight limit per drawer
- Suspension files

	W x D x H(mm)		
O225111	484 x 658 x 740	2 Drawer	£224.18
O225112	484 x 658 x 1048	3 Drawer	£299.75
O225113	484 x 658 x 1360	4 Drawer	£372.77



Wood Finishes



CALL US ON 01527 878348



VISIT WWW.FORWARDPRODUCTS.CO.UK



System Storage Cupboard

- 25mm top, supplied assembled
- Locking, 2 keys
- Supplied empty, accepts Bisley accessories from page 506

	W x D x H(mm)	
O225121	955 x 580 x 740	£257.48
O225122	955 x 580 x 1000	£288.23
O225123	955 x 580 x 1200	£326.01
O225124	955 x 580 x 1600	£365.73
O225125	955 x 580 x 1800	£417.61
O225126	955 x 580 x 2000	£461.16

Sienna storage units are made in the UK with a 10 year warranty and are supplied fully assembled



System Storage Tambour Cupboard

- Locking, 2 Keys
- Supplied empty, accepts Bisley accessories from page 506
- Silver tambour doors

	W x D x H(mm)	
O225131	1100 x 531 x 740	£342.67
O225132	1100 x 531 x 1000	£386.22
O225133	1100 x 531 x 1200	£432.34
O225134	1100 x 531 x 1600	£474.61
O225135	1100 x 531 x 1800	£518.81
O225136	1100 x 531 x 2000	£560.44



Contract Tambour Cupboard

- 25mm top
- Locking, 2 keys
- Includes wooden shelves
- Silver tambour doors

	W x D x H(mm)	Adjustable Shelves	
O225141	1050 x 600 x 1139	2	£452.19
O225142	1050 x 600 x 1539	3	£500.87
O225143	1050 x 600 x 1739	3	£563.64
O225144	1050 x 600 x 1939	4	£601.43

Wood Finishes



Glass Shelf

- Please state which unit shelves are for when ordering

O225151	£48.04
---------	--------

Wooden Shelf

- Please state which unit shelves are for when ordering

O225161	£35.23
---------	--------

Bisley Slotted Shelf

- Fits into System storage units on page 505
- Shelf dividers come in a pack of 5

O225171	Shelf	£38.43
O225172	Dividers	£41.63

Bisley Standard Metal Shelf

- Sold in Silver as standard
- Fits into System storage units on page 505

O225181	£27.54
---------	--------

Bisley Wardrobe Shelf Rail

- Sold in Silver as standard
- Hanging rail sits under shelf
- Fits into System storage units on page 505

O225191	£48.04
---------	--------

Bisley Lateral Filing Rail

- Fits into System storage units on page 505

O225211	£31.38
---------	--------

Bisley Roll Out Suspension Filing Frame

- Fits into System storage units on page 505
- Foolscap or 2 rows of A4
- Includes anti-tilt

O225221	£108.24
---------	---------

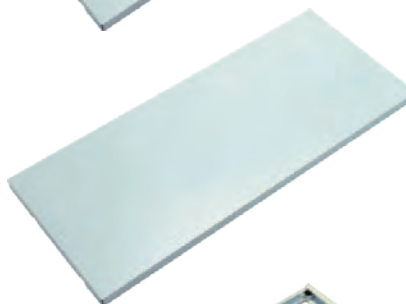
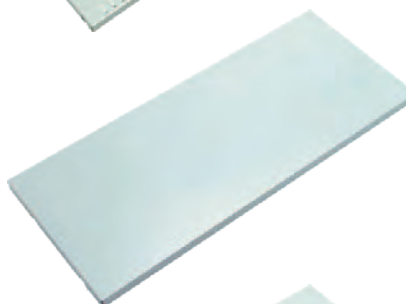



Circular Meeting Table

	Diameter x H(mm)	
O225231	800 x 740	£298.47
O225232	900 x 740	£315.77
O225233	1000 x 740	£339.47
O225234	1200 x 740	£377.25
O225235	1600 x 740	£477.81



Square Meeting Table

	W x D x H(mm)	
O225241	800 x 800 x 740	£298.47
O225242	900 x 900 x 740	£315.77
O225243	1000 x 1000 x 740	£339.47
O225244	1200 x 1200 x 740	£377.25
O225245	1600 x 1600 x 740	£477.81

Wood Finishes



Metalwork Finishes - Silver supplied if not specified

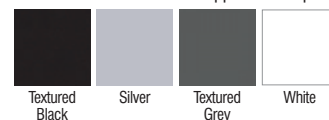



Circular Table - Trumpet Base

	Diameter x H(mm)	
O225251	800 x 740	£223.53
O225252	1000 x 740	£242.11
O225253	1200 x 740	£264.53
O225254	1400 x 740	£301.68

Sienna tables are made in the UK with a 10 year warranty and are supplied fully assembled



Circular Table Crucifix Base

	Diameter x H(mm)	
O225261	800 x 740	£210.08
O225262	900 x 740	£219.69
O225263	1000 x 740	£237.63
O225264	1200 x 740	£264.53
O225265	1600 x 740	£427.21



CALL US ON 01527 878348



VISIT WWW.FORWARDPRODUCTS.CO.UK



40mm Welded Sienna Training Tables

Our 40mm fully welded training tables are built to withstand rigorous use in the most demanding environments.

- 40mm diameter fully welded frame
- Frames are supplied with adjustable feet

Wood Finishes



Metalwork Finishes - Silver supplied if not specified

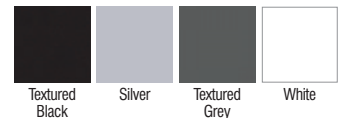

Sienna Rectangular Welded Table

	W x D x H(mm)	
O225271	800 x 800 x 400	£119.13
O225272	800 x 800 x 740	£125.54
O225273	1000 x 800 x 740	£139.63
O225274	1200 x 800 x 740	£144.75
O225275	1400 x 800 x 740	£148.60
O225276	1600 x 800 x 740	£152.44
O225277	1800 x 800 x 740	£168.45
O225278	800 x 600 x 740	£121.70
O225279	1000 x 600 x 740	£134.51
O225281	1200 x 600 x 740	£138.99
O225282	1400 x 600 x 740	£144.75
O225283	1600 x 600 x 740	£147.96
O225284	1800 x 600 x 740	£162.69



Sienna Circular Welded Table

	W x D x H(mm)	
O225291	800 x 800 x 740	£194.71
O225292	1000 x 1000 x 740	£204.96
O225293	1200 x 1200 x 740	£222.89



Sienna tables are made in the UK with a 10 year warranty and are supplied fully assembled

Sienna Semi-Circular Welded Table

	W x D x H(mm)	
O225311	1200 x 600 x 740	£186.39
O225312	1600 x 800 x 740	£208.80



Sienna Trapezoidal Welded Table

	W x D x H(mm)	
O225321	1200 x 693 x 740	£186.39
O225322	1600 x 693 x 740	£208.80





Sienna Rectangular Tubular Leg Table

- Robust design with 80mm tubular legs

	W x D x H(mm)	
O225331	800 x 800 x 740	£201.12
O225332	1000 x 800 x 740	£205.60
O225333	1200 x 800 x 740	£212.01
O225334	1400 x 800 x 740	£223.53
O225335	1600 x 800 x 740	£234.42
O225336	1800 x 800 x 740	£256.84
O225337	800 x 600 x 740	£178.06
O225338	1000 x 600 x 740	£182.54
O225339	1200 x 600 x 740	£185.10
O225341	1400 x 600 x 740	£200.48
O225342	1600 x 600 x 740	£210.72
O225343	1800 x 600 x 740	£232.50

Sienna tables are made in the UK with a 10 year warranty and are supplied fully assembled



Sienna Circular Tubular Leg Table

- Robust design with 80mm tubular legs

	W x D x H(mm)	
O225351	800 x 800 x 740	£252.36
O225352	900 x 900 x 740	£269.65
O225353	1000 x 1000 x 740	£292.07
O225354	1200 x 1200 x 740	£328.58
O225355	1600 x 1600 x 740	£426.57



Sienna Foldaway Table

- Chrome legs as standard

	W x D x H(mm)	
O225361	1400 x 800 x 740	£233.14
O225362	1600 x 800 x 740	£249.15
O225363	1800 x 800 x 740	£270.93

Wood Finishes



Metalwork Finishes - Silver supplied if not specified

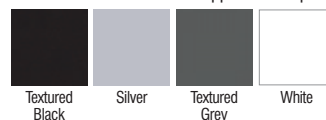

Sienna Rectangular Flip Top Table

- Supplied with lockable castors

	W x D x H(mm)	
O225371	800 x 800 x 740	£273.49
O225372	1000 x 800 x 740	£282.46
O225373	1200 x 800 x 740	£292.07
O225374	1400 x 800 x 740	£303.60
O225375	1600 x 800 x 740	£313.85
O225376	1800 x 800 x 740	£325.37
O225377	800 x 600 x 740	£259.40
O225378	1000 x 600 x 740	£267.09
O225379	1200 x 600 x 740	£275.42
O225381	1400 x 600 x 740	£288.23
O225382	1600 x 600 x 740	£299.11
O225383	1800 x 600 x 740	£307.44



Sienna Trapezoidal Flip Top Table

- 800mm ends
- Supplied with lockable castors

	W x D x H(mm)	
O225391	1600 x 800 x 740	£374.69



Sienna Semi Circular Flip Top Table

- Supplied with lockable castors

	W x D x H(mm)	
O225411	1600 x 800 x 740	£374.69
O225412	1800 x 900 x 740	£385.58



Sienna Rectangular Flip Top Table

- Supplied with lockable castors
- Matt black frame with polished alloy foot

	W x D x H(mm)	
O225421	1200 x 800 x 720	£331.14
O225422	1400 x 800 x 720	£348.43
O225423	1600 x 800 x 720	£356.76
O225424	1800 x 800 x 720	£364.44





Sienna Rio Rectangular Boardroom Table

- Cutting edge design with solid European oak legs to create the right impression in your meeting room
- Sienna Rio boardroom tables are made in the UK with a 10 year warranty and come in a wide range of stylish wood finishes
- Solid European Oak legs
- 2 piece tables will be supplied with 2 tops & 1 leg frame (with central support legs)

	W x D x H(mm)	Top	
O225431	2000 x 1200 x 740	1-Piece	£883.25
O225432	2400 x 1200 x 740	1-Piece	£951.14
O225433	2600 x 1200 x 740	1-Piece	£1018.40
O225434	2800 x 1200 x 740	1-Piece	£1223.36
O225435	3000 x 1200 x 740	2-Piece	£1257.94
O225436	3200 x 1200 x 740	2-Piece	£1325.19
O225437	3400 x 1200 x 740	2-Piece	£1392.45
O225438	3600 x 1200 x 740	2-Piece	£1460.34
O225439	3800 x 1200 x 740	2-Piece	£1527.59
O225441	4000 x 1200 x 740	2-Piece	£1597.41

(Please note that like real woodgrain the MFC grain may not line up exactly on the 2-Piece tops)

Top Finishes





Sienna Rio Rectangular Boardroom Table

- Sleek design with square steel legs to impress staff and visitors
- Sienna Rio boardroom tables are made in the UK with a 10 year warranty and come in a wide range of stylish wood finishes

	W x D x H(mm)	Top	
O225451	2000 x 1200 x 740	1-Piece	£618.08
O225452	2400 x 1200 x 740	1-Piece	£694.94
O225453	2600 x 1200 x 740	1-Piece	£771.80
O225454	2800 x 1200 x 740	2-Piece	£810.87
O225455	3000 x 1200 x 740	2-Piece	£849.94
O225456	3200 x 1200 x 740	2-Piece	£926.16
O225457	3400 x 1200 x 740	2-Piece	£1003.02
O225458	3600 x 1200 x 740	2-Piece	£1079.88
O225459	3800 x 1200 x 740	2-Piece	£1156.74
O225461	4000 x 1200 x 740	2-Piece	£1236.17

(Please note that like real woodgrain the MFC grain may not line up exactly on the 2-Piece tops)



Wood Finishes



Metalwork Finishes - Silver supplied if not specified

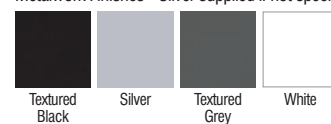

CALL US ON 01527 878348



VISIT WWW.FORWARDPRODUCTS.CO.UK



Sienna Riviera Boardroom Tables

- Create a stylish and airy environment in your meeting room!
- Sienna Riviera boardroom tables are made in the UK with a 10 year warranty and come in a wide range of stylish wood finishes
- Available with rectangular tops, or with shaped tops in 3 different styles, please specify when ordering
- 2800mm - 4000mm tables will be supplied with 2 tops, 2 leg frames and 2 pairs of connecting plates

Rectangular Boardroom Table



	W x D x H(mm)	Top	
O225471	2000 x 1200 x 740	1-Piece	£512.40
O225472	2400 x 1200 x 740	1-Piece	£580.93
O225473	2600 x 1200 x 740	1-Piece	£661.00
O225474	2800 x 1200 x 740	2-Piece	£700.71
O225475	3000 x 1200 x 740	2-Piece	£737.22
O225476	3200 x 1200 x 740	2-Piece	£786.53
O225477	3400 x 1200 x 740	2-Piece	£835.21
O225478	3600 x 1200 x 740	2-Piece	£885.81
O225479	3800 x 1200 x 740	2-Piece	£1005.59
O225481	4000 x 1200 x 740	2-Piece	£1050.42

(Please note that like real woodgrain the MFC grain may not line up exactly on the 2-Piece tops)

Shaped Boardroom Table

- State required shape with order - Oval, D End or Boat options available



'D' D End



'BS' Boat Shaped



'O' Oval

	W x D x H(mm)	Top	
O225491	2000 x 1200 x 740	1-Piece	£643.70
O225492	2400 x 1200 x 740	1-Piece	£674.45
O225493	2600 x 1200 x 740	1-Piece	£801.91
O225494	2800 x 1200 x 740	2-Piece	£866.60
O225495	3000 x 1200 x 740	2-Piece	£930.01
O225496	3200 x 1200 x 740	2-Piece	£1005.59
O225497	3400 x 1200 x 740	2-Piece	£1050.42
O225498	3600 x 1200 x 740	2-Piece	£1112.55
O225499	3800 x 1200 x 740	2-Piece	£1270.11
O225511	4000 x 1200 x 740	2-Piece	£1332.88

(Please note that like real woodgrain the MFC grain may not line up exactly on the 2-Piece tops)

Top Finishes



Metalwork Finishes - Silver supplied if not specified

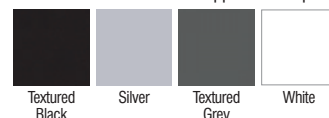

Sienna Vienna Boardroom Tables

- Smart and durable, Vienna boardroom tables provide an inexpensive and professional meeting environment
- Sienna Vienna boardroom tables are made in the UK with a 10 year warranty and come in a wide range of stylish wood finishes
- 2800mm, 3000mm, 3200mm & 3400mm tables will be supplied with 2 tops, 1 leg frame & 2 supporting bars
- 3600mm - 4000mm tables will be supplied with 2 tops, 2 leg frames and 2 pairs of fish plates



Rectangular Boardroom Table

	W x D x H(mm)	Top	
O225521	2000 x 1200 x 740	1-Piece	£399.67
O225522	2400 x 1200 x 740	1-Piece	£459.88
O225523	2600 x 1200 x 740	1-Piece	£525.21
O225524	2800 x 1200 x 740	2-Piece	£559.16
O225525	3000 x 1200 x 740	2-Piece	£593.10
O225526	3200 x 1200 x 740	2-Piece	£639.22
O225527	3400 x 1200 x 740	2-Piece	£689.18
O225528	3600 x 1200 x 740	2-Piece	£737.22
O225529	3800 x 1200 x 740	2-Piece	£872.36
O225531	4000 x 1200 x 740	2-Piece	£930.01

(Please note that like real woodgrain the MFC grain may not line up exactly on the 2-Piece tops)



Shaped Boardroom Table

- State required shape with order - Oval, D End or Boat options available

	W x D x H(mm)	Top	
O225541	2000 x 1200 x 740	1-Piece	£546.99
O225542	2400 x 1200 x 740	1-Piece	£582.21
O225543	2600 x 1200 x 740	1-Piece	£684.05
O225544	2800 x 1200 x 740	2-Piece	£735.29
O225545	3000 x 1200 x 740	2-Piece	£786.53
O225546	3200 x 1200 x 740	2-Piece	£850.58
O225547	3400 x 1200 x 740	2-Piece	£907.59
O225548	3600 x 1200 x 740	2-Piece	£979.97
O225549	3800 x 1200 x 740	2-Piece	£1147.78
O225551	4000 x 1200 x 740	2-Piece	£1197.74

(Please note that like real woodgrain the MFC grain may not line up exactly on the 2-Piece tops)



Wood Finishes



CALL US ON 01527 878348



VISIT WWW.FORWARDPRODUCTS.CO.UK



Sienna Barcelona Boardroom Tables

- Add some design flair to your meeting room with a Sienna Barcelona table
- The curved leg and modesty panel design adds visual interest, specify different panel colours to take this to the next level!
- Sienna furniture is made in the UK and carries a 10 year warranty
- 2800mm, 3000mm, 3200mm & 3400mm tables will be supplied with 2 tops, 1 leg frame & 2 supporting bars
- 3600mm - 4000mm tables will be supplied with 2 tops, 2 leg frames and 2 pairs of fish plates



'D' D End



'BS' Boat Shaped



'O' Oval

Top Finishes



Rectangular Boardroom Table

	W x D x H(mm)	Top	
O225561	2000 x 1200 x 740	1-Piece	£487.42
O225562	2400 x 1200 x 740	1-Piece	£553.39
O225563	2600 x 1200 x 740	1-Piece	£614.88
O225564*	2800 x 1200 x 740	2-Piece	£645.62
O225565*	3000 x 1200 x 740	2-Piece	£676.37
O225566*	3200 x 1200 x 740	2-Piece	£738.50
O225567*	3400 x 1200 x 740	2-Piece	£800.63
O225568*	3600 x 1200 x 740	2-Piece	£860.83
O225569*	3800 x 1200 x 740	2-Piece	£949.86
O225571*	4000 x 1200 x 740	2-Piece	£1036.33

(Please note that like real woodgrain the MFC grain may not line up exactly on the 2-Piece tops)

Shaped Boardroom Table

- State required shape with order - Oval, D End or Boat options available

	W x D x H(mm)	Top	
O225581	2000 x 1200 x 740	1-Piece	£612.96
O225582	2400 x 1200 x 740	1-Piece	£641.78
O225583	2600 x 1200 x 740	1-Piece	£718.64
O225584*	2800 x 1200 x 740	2-Piece	£755.15
O225585*	3000 x 1200 x 740	2-Piece	£792.94
O225586*	3200 x 1200 x 740	2-Piece	£870.44
O225587*	3400 x 1200 x 740	2-Piece	£945.38
O225588*	3600 x 1200 x 740	2-Piece	£1020.96
O225589*	3800 x 1200 x 740	2-Piece	£1097.82
O225591*	4000 x 1200 x 740	2-Piece	£1227.20

(Please note that like real woodgrain the MFC grain may not line up exactly on the 2-Piece tops)





Sienna Panel End Boardroom Tables

- With a fantastic range of shapes and sizes, Sienna Panel End boardroom tables offer the perfect balance of style and value
- Sienna boardroom tables are made in the UK and carry a 10 year warranty
- 2800mm, 3000mm, 3200mm & 3400mm tables will be supplied with 2 tops, 1 leg frame & 2 supporting bars
- 3600mm - 4000mm tables will be supplied with 2 tops, 2 leg frames and 2 pairs of fish plates

Rectangular Boardroom Table

	W x D x H(mm)	Top	
O225611	2000 x 1200 x 740	1-Piece	£399.67
O225612	2400 x 1200 x 740	1-Piece	£459.88
O225613	2600 x 1200 x 740	1-Piece	£525.21
O225614*	2800 x 1200 x 740	2-Piece	£559.16
O225615*	3000 x 1200 x 740	2-Piece	£593.10
O225616*	3200 x 1200 x 740	2-Piece	£639.22
O225617*	3400 x 1200 x 740	2-Piece	£689.18
O225618*	3600 x 1200 x 740	2-Piece	£737.22
O225619*	3800 x 1200 x 740	2-Piece	£872.36
O225621*	4000 x 1200 x 740	2-Piece	£930.01

(Please note that like real woodgrain the MFC grain may not line up exactly on the 2-Piece tops)



Shaped Boardroom Table

- State required shape with order - Oval, D End or Boat options available

	W x D x H(mm)	Top	
O225631	2000 x 1200 x 740	1-Piece	£546.99
O225632	2400 x 1200 x 740	1-Piece	£582.21
O225633	2600 x 1200 x 740	1-Piece	£684.05
O225634*	2800 x 1200 x 740	2-Piece	£735.29
O225635*	3000 x 1200 x 740	2-Piece	£786.53
O225636*	3200 x 1200 x 740	2-Piece	£850.58
O225637*	3400 x 1200 x 740	2-Piece	£907.59
O225638*	3600 x 1200 x 740	2-Piece	£979.97
O225639*	3800 x 1200 x 740	2-Piece	£1147.78
O225641*	4000 x 1200 x 740	2-Piece	£1197.74

(Please note that like real woodgrain the MFC grain may not line up exactly on the 2-Piece tops)



'D' D End



'BS' Boat Shaped



'O' Oval



CALL US ON 01527 878348



VISIT WWW.FORWARDPRODUCTS.CO.UK



Sienna Trumpet Base Coffee Tables

- Stylish trumpet base design with a robust 25mm MFC top
- Supplied with stainless steel base as standard - otherwise please specify powder coat colour from below options
- Made in the UK with a 10 year warranty

Circular

	W x D x H(mm)	
O225651	600 x 600 x 465	£155.00
O225652	700 x 700 x 465	£163.33
O225653	800 x 800 x 465	£172.94

Curved Square

	W x D x H(mm)	
O225661	600 x 600 x 465	£155.00
O225662	700 x 700 x 465	£163.33
O225663	800 x 800 x 465	£172.94

Square

	W x D x H(mm)	
O225671	600 x 600 x 465	£131.94
O225672	700 x 700 x 465	£139.63
O225673	800 x 800 x 465	£149.88

Rectangular

	W x D x H(mm)	
O225681	800 x 600 x 465	£139.63
O225682	900 x 500 x 465	£139.63
O225683	1200 x 600 x 465	£263.25

Top Finishes



Metalwork Finishes - Stainless Steel supplied if not specified

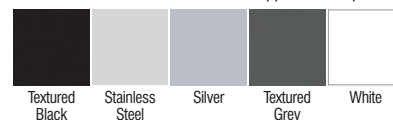



Sienna Hairpin Leg Coffee Tables

- A modern classic, hairpin legs add elegance to your breakout areas!
- Frames come in black only, with a wide range of wood finishes
- Made in the UK with 10 year warranty
- Available with black frame only

Circular

	W x D x H(mm)	
O225691	600 x 600 x 410	£155.00
O225692	700 x 700 x 410	£163.33
O225693	800 x 800 x 410	£172.94

Curved Square

	W x D x H(mm)	
O225711	600 x 600 x 410	£155.00
O225712	700 x 700 x 410	£163.33
O225713	800 x 800 x 410	£172.94

Square

	W x D x H(mm)	
O225721	600 x 600 x 410	£131.94
O225722	700 x 700 x 410	£139.63
O225723	800 x 800 x 410	£149.88

Rectangular

	W x D x H(mm)	
O225731	800 x 600 x 410	£139.63
O225732	900 x 500 x 410	£139.63
O225733	1200 x 600 x 410	£196.63

Top Finishes



CALL US ON 01527 878348



VISIT WWW.FORWARDPRODUCTS.CO.UK



Sienna Tubular Leg Coffee Tables

- Robust tubular legs and 25mm MFC top
- Available in a wide range of colours
- Made in the UK with a 10 year warranty

Circular

	W x D x H(mm)	
O225741	600 x 600 x 400	£155.00
O225742	700 x 700 x 400	£163.33
O225743	800 x 800 x 400	£172.94

Curved Square

	W x D x H(mm)	
O225751	600 x 600 x 400	£155.00
O225752	700 x 700 x 400	£163.33
O225753	800 x 800 x 400	£172.94

Square

	W x D x H(mm)	
O225761	600 x 600 x 400	£131.94
O225762	700 x 700 x 400	£139.63
O225763	800 x 800 x 400	£149.88

Rectangular

	W x D x H(mm)	
O225771	800 x 600 x 400	£139.63
O225772	900 x 500 x 400	£139.63
O225773	1200 x 600 x 400	£196.63

Top Finishes



Metalwork Finishes - Silver supplied if not specified

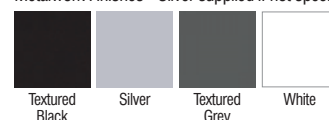

Signature Tables

- Funky range of two tier tables
- Mixture of clear and frosted glass for unique looks
- Polished chrome legs
- Toughened glass tops

S211481	Boat Shaped Table W1190 x D690 x H450mm	£247.03
S211482	Shield Shaped Table W890 x D890 x H450mm	£240.45
S211483	Square Table W700 x H450mm	£268.80
S211484	Rectangular Table W1200 x D600 x H465mm	£324.79



Signature Boat Table



Signature Shield Table



Signature Square Table

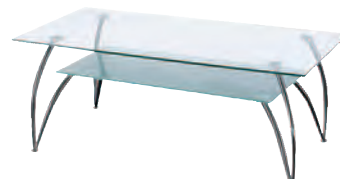

Signature Rectangular Table



Crystal Circular

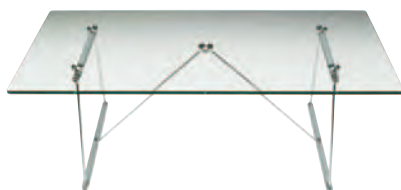

Crystal Rectangular

Crystal Tables

- Stylish clear glass tables
- Silver and brushed steel bases
- Toughened glass tops

S211491	Circular D500 x H590mm	£213.03
S211492	Rectangular W1200 x D600 x H420mm	£277.43

Please see Important Furniture Ordering Information on page 306 before placing your furniture order

Shimmer Tables

- Classic glass top coffee tables
- Chrome legs
- Toughened clear glass tops

S211511	Rectangular W900 x D500 x H340mm	£240.09
S211512	Square W500 x H340mm	£185.07



Shimmer Rectangular



Shimmer Square



CALL US ON 01527 878348



VISIT WWW.FORWARDPRODUCTS.CO.UK



Our
Express Furniture
is available for
rapid delivery in
only 1-2 days!



18

Express Furniture

Office Seating	525
Cantilever Desks	526
Panel End Desks	527
Pedestals & Filing Cabinets	528
Bookcases & Filing Cabinets	529
Steel Storage	530

Express Range

- 1-2 day delivery
- Desks and wooden cupboards delivered flat packed
- Desks and wooden storage available in four top finishes and two frame finishes
- **Please see Important Furniture Ordering Information on page 306 before placing your furniture order**



Express Meeting Chairs

- Cushioned seat and back for added comfort
- Robust black or chrome frame options
- 5 year component guarantee and 2 year upholstery guarantee
- Available in 6 upholstery colours

X211111	With Black Frame	£46.28
X211112	With Chrome Frame	£47.58



+ Now available in anti-microbial woven fabric, effective against Covid-19 see page 565



Express Extra Comfort Chair

- Deep cushioned seat and back in a tough wearing fabric
- Physio approved ergonomic features
- Height adjustable arms, ratchet back, inflatable lumbar support and seat slide
- 5 year component guarantee and 2 year upholstery guarantee
- Available in Royal Blue or Charcoal as standard

X211131	Extra Comfort Chair	£246.48
---------	---------------------	---------

Express Operator Chairs

- Deep cushioned seat and back in a tough wearing fabric
- Fixed back for maximum strength
- 2 year guarantee
- Available in 6 upholstery colours

X211121	Without Arms	£79.54
X211122	With Fixed Arms	£102.44
X211123	With Adjustable Arms	£118.51

Express Chair Fabric Options





Express Cantilever Desks

- Cost effective cantilever leg workstation range
- 25mm thick tops
- 5 year guarantee
- Available in 4 top colours and 2 frame colours – please specify when ordering
- Supplied flat packed for self-assembly
- **Please see Important Furniture Ordering Information on page 306 before placing your furniture order**

Top Finishes



Beech

Oak

White

Grey Oak

Frame Finishes



White

Silver



Crescent Desks (right hand pictured)

X211173	Left W1600/1200 x D800/600mm	£196.25
X211174	Right W1600/1200 x D800/600mm	£196.25
X211175	Left W1800/1200 x D800/600mm	£256.72
X211176	Right W1800/1200 x D800/600mm	£256.72



Supplied
flat-packed
in just
1-2 days



600mm Deep Rectangular Desks

X211141	W800 x D600mm	£118.98
X211142	W1200 x D600mm	£145.86
X211143	W1400 x D600mm	£161.98
X211144	W1600 x D600mm	£174.72
X211145	W1800 x D600mm	£192.19

800mm Deep Rectangular Desks

X211151	W800 x D800mm	£123.66
X211152	W1200 x D800mm	£152.57
X211153	W1400 x D800mm	£174.72
X211154	W1600 x D800mm	£181.48
X211155	W1800 x D800mm	£200.30



CALL US ON 01527 878348



VISIT WWW.FORWARDPRODUCTS.CO.UK



Supplied flat-packed in just 1-2 days

Express Panel End Desks

- Contemporary panel end workstation range
- 25mm thick tops
- 5 year guarantee
- Available in 4 top colours – please specify when ordering
- Supplied flat packed for self-assembly
- **Please see Important Furniture Ordering Information on page 306 before placing your furniture order**



600mm Deep Rectangular Desks

Top Finishes



Beech Oak White Grey Oak

X211181	W800 x D600mm	£118.98
X211182	W1200 x D600mm	£145.86
X211183	W1400 x D600mm	£168.01
X211184	W1600 x D600mm	£174.72
X211185	W1800 x D600mm	£192.19



Crescent Desks (left hand pictured)

X211215	Left W1600/1200 x D800/600mm	£196.25
X211216	Right W1600/1200 x D800/600mm	£196.25
X211217	Left W1800/1200 x D800/600mm	£256.72
X211218	Right W1800/1200 x D800/600mm	£256.72



800mm Deep Rectangular Desks

X211191	W800 x D800mm	£123.66
X211192	W1200 x D800mm	£152.57
X211193	W1400 x D800mm	£174.72
X211194	W1600 x D800mm	£181.48
X211195	W1800 x D800mm	£200.30



Express Wooden Filing

- 5 year guarantee
- Available in 4 colours - please specify when ordering
- **Please see Important Furniture Ordering Information on page 306 before placing your furniture order**

Top Finishes



Beech

Oak

White

Grey Oak

Delivered
in just
1-2 days



2 Drawer Fixed Pedestal

- Compatible with 800mm deep desks

X211231 W400 x D500 x H495mm £128.39



3 Drawer Fixed Pedestal

- Compatible with 800mm deep desks

X211232 W400 x D500 x H495mm £128.39



2 Drawer Mobile Pedestal

X211233 W404 x D500 x H595mm £131.72



3 Drawer Mobile Pedestal

X211234 W404 x D500 x H595mm £131.72



3 Drawer Under Desk Pedestal

X211235 W404 x D500 x H690mm £185.48



3 Drawer Desk High Pedestal

X211236 W404 x D600 x H730mm £185.48

X211237 W404 x D800 x H730mm £233.22



2 Drawer Filing Cabinet

X211241 W464 x D600 x H710mm £236.55



4 Drawer Filing Cabinet

X211242 W464 x D600 x H1365mm £324.58



Heavy Duty Desk High Side Filer

X211243 W800 x D600 x H730mm £442.21



CALL US ON 01527 878348



VISIT WWW.FORWARDPRODUCTS.CO.UK

Express Wooden Storage

- Please see Important Furniture Ordering Information on page 306 before placing your furniture order



Supplied flat-packed in just 1-2 days



Open Fronted Bookcases

- Adjustable Shelves
- 5 year guarantee

X211251	1 Shelf W800 x D450 x H730mm	£121.63
X211253	3 Shelves W800 x D450 x H1200mm	£176.07
X211254	4 Shelves W800 x D450 x H1800mm	£196.25
X211255	5 Shelves W800 x D450 x H2000mm	£216.42

Double Door Cupboards

- Adjustable Shelves
- 5 year guarantee

X211261	1 Shelf W800 x D450 x H730mm	£162.66
X211263	3 Shelves W800 x D450 x H1200mm	£229.84
X211264	4 Shelves W800 x D450 x H1800mm	£256.72
X211265	5 Shelves W800 x D450 x H2000mm	£284.28

Wooden Storage Finishes



Filing Cabinet Finishes

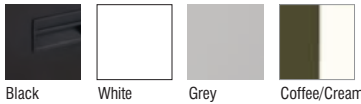

2 Drawer Steel Filing Cabinet

- 465mm wide x 620mm deep
- 7 year guarantee

X211271 2 Drawer - H700mm £134.58



3 Drawer Steel Filing Cabinet

- 465mm wide x 620mm deep
- 7 year guarantee

X211272 3 Drawer - H1000mm £175.34



4 Drawer Steel Filing Cabinet

- 465mm wide x 620mm deep
- 7 year guarantee

X211273 4 Drawer - H1300mm £187.62



Express Steel Storage

- 7 year guarantee
- All units lockable
- **Please see Important Furniture Ordering Information on page 306 before placing your furniture order**



Double Door & Tambour Cupboard Finishes



Steel Double Door Cupboards

- Adjustable shelves included
- Lockable doors
- Additional shelves available

	Shelves	Dimensions (mm)	
X211281	2	W920 x D420 x H1000	£166.61
X211282	4	W920 x D420 x H1790	£229.01
X211283	4	W920 x D420 x H1900	£251.63
X211284	Dual purpose adjustable shelf		£16.59



Tambour Cupboards

- Adjustable shelves included
- Lockable doors
- Additional shelves available
- Roll out filing frame available

Cupboards	Shelves		
X211291	2	W1000 x D450 x H1050mm	£333.84
X211292	4	W1000 x D450 x H1950mm	£407.68

Accessories

X211293	Dual purpose adjustable shelf	£23.71
X211294	Roll out filing frame	£93.81



Pedestal Finishes



Steel Mobile 3 Drawer Pedestals

- Standard or slimline (300mm wide) options

X211311	W380 x D470 x H615mm	£160.37
X211312	W300 x D470 x H615mm	£160.37



CALL US ON 01527 878348



VISIT WWW.FORWARDPRODUCTS.CO.UK



19

Steel Storage

Steel Filing Cabinets	533-534
Steel Storage Cupboards	535-537
Steel Pedestals	538
Safes	539
Fire Resistant Cupboards	540
Lockers	541-544



Standard Filing Cabinet

- 40kg suspension file carrying capacity per drawer
- 10 year guarantee
- Anti-tilt locking mechanism
- 100% drawer extension
- 458mm wide x 622mm deep
- Standard colours: Light Grey and Coffee Cream
- **Please see Important Furniture Ordering Information on page 306 before placing your furniture order**

O212971	2 Drawer - 711mm High	£121.15
O212972	3 Drawer - 1009mm High	£141.33
O212973	4 Drawer - 1320mm High	£148.90

* Please specify colour when ordering

Standard Colours

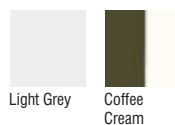

Coloured Filing Cabinet

- 40kg suspension file carrying capacity per drawer
- 10 year guarantee
- Anti-tilt locking mechanism
- 100% drawer extension
- 458mm wide x 622mm deep
- Premium colours available as shown below
- **Please see Important Furniture Ordering Information on page 306 before placing your furniture order**

O212981	2 Drawer Coloured - H711mm	£136.47
O212982	3 Drawer Coloured - H1009mm	£146.96
O212983	4 Drawer Coloured - H1320mm	£165.33

* Please specify colour when ordering



Please Specify:
Colour

Standard Colours

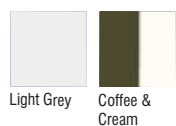

Premium Colours

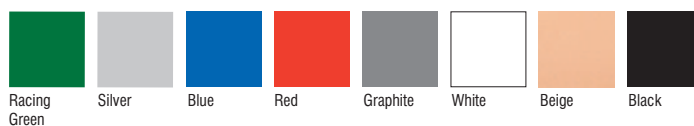

Premium Filing Cabinet

- 40kg suspension file carrying capacity per drawer
- 15 year guarantee
- 100% drawer extension
- Stylish swan neck handle design
- 458mm wide x 622mm deep
- Standard colours: Light Grey and Coffee Cream
- Premium colours available as previous page, price on application
- **Please see Important Furniture Ordering Information on page 306 before placing your furniture order**

O212991	2 Drawer - 711mm High	£137.58
O212992	3 Drawer - 1009mm High	£155.42
O212993	4 Drawer - 1320mm High	£173.25

* Please specify colour when ordering

Standard Colours



Light Grey



Coffee Cream

Premium colours - see previous page, price on application



Multidrawer Storage Units

- Locking and non-locking
- 5 year guarantee
- Smooth running drawers
- Available in Light Grey, Coffee Cream, and Black
- **Please see Important Furniture Ordering Information on page 306 before placing your furniture order**

O213111	5 Drawer Locking	£95.55
O213112	10 Drawer Locking	£138.86
O213113	15 Drawer Locking	£196.19
O213114	5 Drawer Non Locking	£95.99
O213115	10 Drawer Non Locking	£126.12
O213116	15 Drawer Non Locking	£177.07

* Please specify colour when ordering



CALL US ON 01527 878348



VISIT WWW.FORWARDPRODUCTS.CO.UK



Standard Storage Cupboard

- Two locking doors with strengthener
- 5 year guarantee
- 5 heights available
- 915mm wide x 458mm deep
- Standard colours: Light Grey and Coffee Cream
- Premium colours available to order, price on application
- **Please see Important Furniture Ordering Information on page 306 before placing your furniture order**

O213121	690mm High	£168.93
O213122	1020mm High	£176.72
O213123	1650mm High	£200.11
O213124	1830mm High	£204.01
O213125	1950mm High	£249.49

Cupboards supplied empty - choose accessories from range on page 234



Please Specify:

Colour

Standard Colours

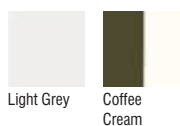

Light Grey

Coffee Cream

Premium Colours

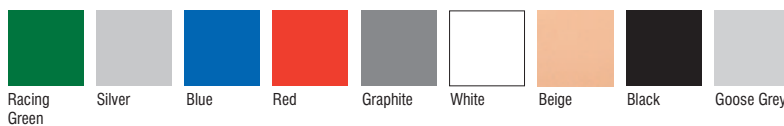

Racing Green

Silver

Blue

Red

Graphite

White

Beige

Black

Goose Grey



Premium Storage Cupboard

- Locking doors with full length reinforcements
- 10 year guarantee
- Security bar option
- 915mm wide x 458mm deep
- Standard colours: Light Grey and Coffee Cream
- Premium colours available to order, price on application
- **Please see Important Furniture Ordering Information on page 306 before placing your furniture order**

O213131	1020mm High	£189.04
O213132	1830mm High	£216.58
O213133	1950mm High	£264.93

Cupboards supplied empty - choose accessories from range on page 234



Standard Side Tambour Cupboard

- Magnetic handle strip
- Smooth running track
- 5 year guarantee
- 5 heights available
- 1000mm wide x 507mm deep
- Standard colours: Light Grey and Coffee Cream
- Premium colours available to order as previous page, price on application
- **Please see Important Furniture Ordering Information on page 306 before placing your furniture order**

O213141	690mm High	£321.46
O213142	1016mm High	£342.10
O213143	1320mm High	£364.84
O213144	1651mm High	£385.18
O213145	2000mm High	£401.54

Cupboards supplied empty - choose accessories from range on page 234



Premium Side Tambour Cupboard

- Smooth track glide system
- 15 year guarantee
- 7 heights available
- 1000mm wide x 507mm deep
- Standard carcass colours: Light Grey and Coffee Cream
- Premium colours available to order as previous page, price on application
- Standard tambour colour Grey
- Other colours available to order - Graphite, Silver, Red, Blue and Green - price on application
- **Please see Important Furniture Ordering Information on page 306 before placing your furniture order**

O213151	690mm High	£396.37
O213152	1016mm High	£437.37
O213153	1200mm High	£453.78
O213154	1320mm High	£510.85
O213155	1651mm High	£550.39
O213156	2000mm High	£559.96
O213157	2210mm High	£650.89

Cupboards supplied empty - choose accessories from range on page 234



The cupboard accessories below can be used inside all storage units on pages 535-536



O213161
Plain Shelf, 330mm Hanging
£17.50



O213162
Wardrobe Shelf
£37.58



O213163
Lateral Filing Frame
£23.37



O213164
Roll Out Shelf
£79.89



O213165
Letter Sorter
£154.79



O213166
Roll Out Slotted Drawer
£103.83



O213167
Slotted Shelf
£31.21



O213169
Roll Out Suspension Filing Frame
£79.89

Please see Important Furniture Ordering Information on page 306 before placing your furniture order

NB: Roll-out fittings are only recommended in the bottom half of the unit. Remember to specify anti-tilt with roll-out filing.



Cube Pedestals

- Super strong, smart option for the modern office
- Range includes narrow (300mm) width – ideal for small desks
- Choice of white or silver
- Free drawer dividers and pen tray with every pedestal
- Hidden 5th castor on filing drawer
- Solid Nylon castors (unbreakable)
- 5 year guarantee
- Compact 500mm depth – doesn't clash with large cable trays
- Main colour used inside drawers
- Central locking – free master key with large orders
- **Please see Important Furniture Ordering Information on page 306 before placing your furniture order**



White Pedestals, Standard and Narrow Widths



3 Drawer, Silver Pedestals, Standard & Low Heights



A



A. Steel Low Mobile Pedestal

- 1 Personal drawer 1 File drawer
- 410 x 500 x H495mm

O213171	Silver	£146.99
O213172	White	£146.99

B



B. Steel Narrow Low Mobile Pedestal

- 1 Personal drawer 1 File drawer
- 300 x 500 x H495mm

O213191	Silver	£143.32
O213192	White	£143.32

C



C. Steel Mobile Pedestal

- 2 Personal drawers 1 File drawer
- 410 x 500 x H597mm

O213221	Silver	£174.55
O213222	White	£174.55

D



D. Steel Narrow Mobile Pedestal

- 2 Personal drawers 1 File drawer
- 300 x 500 x H597mm

O213231	Silver	£170.26
O213232	White	£170.26



All CUBE Steel Pedestals Come With Free Drawer Dividers & Pen Tray



CALL US ON 01527 878348



VISIT WWW.FORWARDPRODUCTS.CO.UK



**LIFETIME
GUARANTEE**

Lock styles
may vary -
please check
when ordering

Please
see Important
Furniture Ordering
Information on page
306 before placing
your furniture
order

Electronic Safes

- Fine powder coat finish
- 5mm door and 2.5mm body
- Batteries supplied
- Fixing holes and bolts included
- Manufacturer's insurance rating for cash and jewellery
- Lifetime guarantee

	Internal Size h x w x d (mm)	Capacity Litres	Weight Kg	
O213241	180 x 300 x 225	12	28	£238.69
O213242	358 x 215 x 265	20	42	£276.47
O213243	393 x 323 x 300	38	75	£310.81



Fire Resistant Safe

- Fire rated to 1 hour at 1030°C
- Fitted with high security double bitted VDS Class 1 key lock
- Fixing bolts supplied
- Manufacturer's insurance rating for cash and jewellery

	Internal Size h x w x d (mm)	Capacity Litres	Weight Kg	
O213251	140 x 270 x 200	18	20	£204.35
O213252	270 x 370 x 250	28	40	£274.75
O213253	470 x 370 x 250	43	56	£372.63



Fire Resistant Media Safe

- A compact data safe for convenient storage of important disks and electronic records
- Magnetic media fully protected

	Internal Size h x w x d (mm)	Capacity Litres	Weight Kg	
O213261	245 x 155 x 197	7	43	£403.54
O213262	380 x 235 x 187	17	95	£789.91
O213263	495 x 400 x 405	80	242	£1404.67



Fire Resistant Cupboards

- High security cupboards with double walled construction
- Perfect for storing sensitive exam papers
- Fire resistant to 30 minutes
- 3 way locking system
- Adjustable shelves
- Standard colour grey (RAL7035)
- Internal fittings available at extra cost. Please call for details.

Code	Internal Size h x w x d (mm)	CapacityWeight		
		Litres	Kg	
O213271	1082 x 506 x 415	230	71	£946.18
	3 Shelves Light Grey			
O213272	1050 x 814 x 415	359	90	£1202.04
	4 Shelves Light Grey			
O213273	1810 x 814 x 415	615	142	£1507.70
	4 Shelves Light Grey			

* Delivery of security cupboards is free of charge to a ground floor location with no more than one step involved

**Other delivery locations will require a site survey and quotation



Please see Important Furniture Ordering Information on page 306 before placing your furniture order

Double Secure Filing Cabinets

- Robust filing cabinets with locking bar system giving high security storage at a budget price
- 100% drawer extension
- 7 year guarantee
- Available in Goose Grey or Coffee Cream

O213281	2 Drawer	£242.88
O213282	3 Drawer	£275.03
O213283	4 Drawer	£294.67



Please check external dimensions when ordering

Fire Resistant Filing Cabinets

- Light grey filing cabinets
- Fire resistant for 90 minutes
- Individual fire protection for all drawers
- Drop tested to ISO 9001

O213291	2 Drawer	145kg	£1037.19
O213292	4 Drawer	266kg	£1511.14



UK Manufactured



Please call for bulk prices

Please Specify:

1. Nesting (please call for options)
2. Door colour
3. Carcass colour

Door Colours



Autumn Colour Door Options (available for 305mm wide lockers only)



Single Compartment

- Including top shelf and double coat hook

		Single	Nest of 2 (*N2)	Nest of 3 (*N3)
O213311*	H1780 x W305 x D305mm	£88.73	£164.89	£242.17
O213312*	H1780 x W305 x D380mm	£95.22	£175.56	£257.09
O213313*	H1780 x W305 x D460mm	£106.05	£193.49	£282.31
O213314*	H1780 x W380 x D380mm	£106.05	£193.49	£282.31
O213315*	H1780 x W460 x D460mm	£125.93	£232.68	N/A

* Please specify door colours and carcass colour

Two Compartment

- Including double coat hook per compartment

		Single	Nest of 2 (*N2)	Nest of 3 (*N3)
O213321*	H1780 x W305 x D305mm	£116.57	£218.88	£323.16
O213322*	H1780 x W305 x D380mm	£120.64	£225.80	£332.46
O213323*	H1780 x W305 x D460mm	£129.49	£239.85	£351.83
O213324*	H1780 x W380 x D380mm	£129.49	£239.85	£351.83
O213325*	H1780 x W460 x D460mm	£152.29	£254.24	N/A

* Please specify door colours and carcass colour

Three Compartment

		Single	Nest of 2 (*N2)	Nest of 3 (*N3)
O213331*	H1780 x W305 x D305mm	£110.98	£212.79	£314.59
O213332*	H1780 x W305 x D380mm	£130.90	£249.33	£367.76
O213333*	H1780 x W305 x D460mm	£124.44	£234.68	£344.93
O213334*	H1780 x W460 x D460mm	£159.80	£303.71	N/A

* Please specify door colours and carcass colour

Four Compartment

		Single	Nest of 2 (*N2)	Nest of 3 (*N3)
O213341*	H1780 x W305 x D305mm	£118.68	£228.16	£337.62
O213342*	H1780 x W305 x D380mm	£143.22	£273.99	£404.75
O213343*	H1780 x W305 x D460mm	£133.31	£252.45	£371.59
O213344*	H1780 x W380 x D380mm	£149.31	£282.74	£416.17
O213345*	H1780 x W460 x D460mm	£173.77	£331.65	N/A

* Please specify door colours and carcass colour

Five Compartment

		Single	Nest of 2 (*N2)	Nest of 3 (*N3)
O213351*	H1780 x W305 x D305mm	£142.31	£274.33	£406.34
O213352*	H1780 x W305 x D380mm	£147.96	£283.47	£418.98
O213353*	H1780 x W305 x D460mm	£156.00	£296.40	£436.64

* Please specify door colours and carcass colour

Six Compartment

		Single	Nest of 2 (*N2)	Nest of 3 (*N3)
O213361*	H1780 x W305 x D305mm	£163.89	£317.47	£471.05
O213362*	H1780 x W305 x D380mm	£166.33	£320.22	£474.10
O213363*	H1780 x W305 x D460mm	£178.49	£341.08	£503.68
O213364*	H1780 x W380 x D380mm	£178.49	£341.08	£503.68

* Please specify door colours and carcass colour

Please see Important Furniture Ordering Information on page 306 before placing your furniture order



- All lockers come as standard with Activecoat anti-bacterial powder coating
- All plastic components used in the manufacturing incorporate a silver based anti-bacterial agent
- Activecoat developed in conjunction with Dupont

- Ergonomic Card Holder incorporating a lock cover which protects the lockers from key scratches



- Vent system allows each compartment to 'breathe'



- Even the standard lock has a micro sprung 10 lock featuring a massive 3000 serial combinators



- Every locker has a full strengthener welded into each door to increase security



- Between each compartment the locker has a welded plinth. This makes each compartment totally separate and increases structural rigidity



- High visibility key, making identification easy. Hasp and staple locks for padlocks are also available



All lockers meet:



Please see Important Furniture Ordering Information on page 306 before placing your furniture order

Lock options: Cam lock supplied as standard
Combination Lock 3 Digit, Digital Combination Lock



Combination Lock 3 Digit



Digital Combination Lock

ACTIVECOAT
anti-bacterial technology



- The hard wearing anti-bacterial powder coating for the most stringent hygienic environment

- **Iron Phosphate Key Coat**
This anti-rust, key coat bonds to the steel in readiness for the final active coating

- **Prepared Steel Surface**
Chemical cleaning ensures an ideal surface for further coatings

A Low Lockers Single Tier

- Including top shelf and double coat hook

		Single	Nest of 2 (*N2)	Nest of 3 (*N3)
O213371*	H1210 x W305 x D305mm	£79.17	£150.73	£222.30
O213372*	H1210 x W305 x D460mm	£96.28	£181.77	£267.24

* Please specify door colours and carcass colour

B Low Lockers Double Tier

		Single	Nest of 2 (*N2)	Nest of 3 (*N3)
O213381*	H1210 x W305 x D305mm	£106.15	£204.70	£303.25
O213382*	H1780 x W305 x D460mm	£119.43	£228.05	£336.67

* Please specify door colours and carcass colour

C Cube Lockers

		Single	Nest of 2 (*N2)	Nest of 3 (*N3)
O213391*	H305 x W305 x D305mm	£47.13	£91.72	£138.33
O213392*	H380 x W380 x D380mm	£55.35	£107.47	£161.94
O213393*	H460 x W460 x D460mm	£61.37	£118.99	£179.24

* Please specify door colours and carcass colour

D Janitors Lockers

- Including top shelf and double coat hook

		Single	Nest of 2 (*N2)	Nest of 3 (*N3)
O213411*	H1780 x W460 x D460mm	£167.75	£319.61	N/A

* Please specify door colours and carcass colour





Shockbox Laminate Door Lockers

- 10 year guarantee
- Steel carcass with heavy duty 10mm solid grade laminate overlaid doors to withstand vandalism
- Durable 180° hinges
- Anti-bacterial finish
- Supplied with cam lock or hasp and staple lock – please specify when ordering
- End panels and other extras available
- **Please see Important Furniture Ordering Information on page 306 before placing your furniture order**



Shown with optional sloping tops

Locker Configurations

- All lockers 305mm wide x 1780mm high

	No. of Compartments	Depth (mm)	
O213511	1	390	£192.88
O213512	1	470	£205.79
O213513	2	390	£241.09
O213514	2	470	£250.56
O213515	3	390	£289.91
O213516	3	470	£297.83
O213517	4	390	£331.88
O213518	4	470	£344.68

Optional Extras

O213520	Sloping Top Caps – each	£13.28
O213521	390mm Deep Straight End Panel	£154.72
O213522	470mm Deep Straight End Panel	£188.06
O213523	390mm Deep Sloping Top End Panel	£166.03
O213524	390mm Deep Sloping Top End Panel	£199.19
O213525	Aluminium Round Number Cut into Door	£3.75

Please Specify:

1. Door colour
2. Body colour

Standard Door Colours*

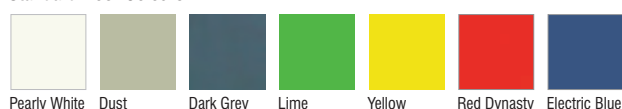

* Other colours available to order

Body Colour



Silver



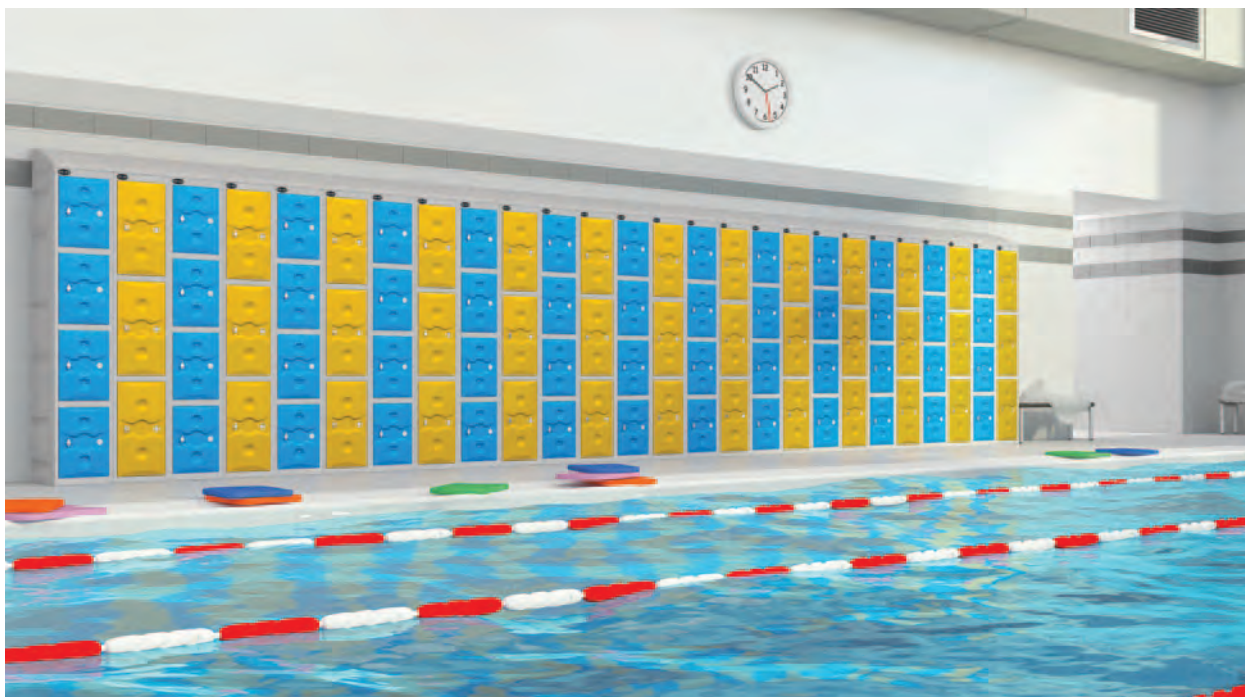

Ultrabox Plastic Lockers

- 10 year guarantee
- Waterproof if sheltered from direct rain
- Vandal resistant
- Anti-bacterial finish
- Supplied with waterproof cam lock or water resistant hasp and staple lock – please specify when ordering
- Other locks available, please call for details
- **Please see Important Furniture Ordering Information on page 306 before placing your furniture order**



Locker Configurations

- All lockers 325mm wide x 450mm deep

	No. of Compartments	Height (mm)	
O213530	2	1800	£395.69
O213531	3	1800	£404.51
O213532	4	1800	£404.51

Mini Lockers

O213533	2 Door	900	£251.52
O213534	1 Door	450	£122.04

Optional Extras

O213535	Sloping Top Caps each	£55.78
O213536	Adjustable Feet (x4 Per Locker)	£18.40



Lockers with Sloping Top Caps

Please Specify:

1. Door colour
2. Body colour

Door Colours

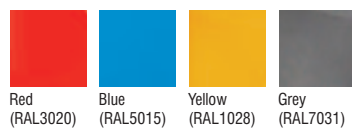

Body Colour



Adjustable Feet



Sloping Top



CALL US ON 01527 878348



VISIT WWW.FORWARDPRODUCTS.CO.UK



20

Dining Furniture

Folding Tables	547-549
Tilt Top Tables	550
Frontier Tables	551-552
Chill & Groove Table & Bench Sets	553-554
Dining Chairs & Stools	555-558



Flexible Dining Tables

- Transform your hall into a multi-use area effortlessly, in minutes, without the need for heavy lifting
- Choice of three heights for Primary and Secondary usage
- Double sided laminated MDF tops with ultra-tough edges give a water resistant, easy-clean finish for improved cleanliness
- Fully certified by FIRA
- All tables can fit through a standard height doorway (1980mm)
- Tables have a Grey frame
- 16 year frame guarantee
- **Please see Important Furniture Ordering Information on page 306 before placing your furniture order**

Mobile Folding Bench Units

- Rectangular units
- Each unit seats 12-16 depending on pupil age

D211001* W3080 x D1400 x H685mm £750.00

D211002* W3080 x D1400 x H735mm £750.00

*Please specify top colour, see options below



Top colours available

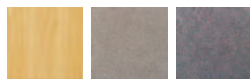

Maple

Grey

Blue/Grey

Mobile Convertible Bench Units

- Each bench seats 4-6 children
- Versatile design means benches can be used for classroom style tables, auditorium type seating or, join two units together to form cafeteria/dining tables
- Lockable castors

D211003* W2435 x D730 x H685mm £525.00

D211004* W2435 x D730 x H735mm £525.00

*Please specify top colour, see options below



Convertible Tables - Upright



Two Convertible Tables - Flat



Single Convertible Tables - Flat





Rectangular Mobile Folding Stool Tables

- Perfect where space is at a premium, these tables are flexible, compact and store in minimal areas

	No. Seats			
D211010*	8	W2380 x D1500 x H685mm	£735.00	
D211011*	8	W2380 x D1500 x H735mm	£735.00	
D211012*	12	W3080 x D1500 x H685mm	£813.00	
D211013*	12	W3080 x D1500 x H735mm	£813.00	
D211014*	16	W3280 x D1500 x H650mm	£938.00	

*Please specify top & stool colours, see options below

Shaped Mobile Folding Stool Tables

Round Unit

	No. Seats		
D211020*	8	W2130 x D2155 x H685mm	£861.78
D211021*	8	W2130 x D2155 x H735mm	£861.78

Octagonal Units

	No. Seats		
D211022*	8	W2130 x D2155 x H685mm	£813.00
D211023*	8	W2130 x D2155 x H735mm	£813.00

*Please specify top & stool colours, see options below



8 Seat Rectangular Table



Round Table



Octagonal Table



Octagonal Table - Folded

Top colours available

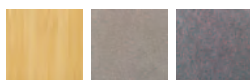

Maple Grey Blue/Grey

Stool colours available



Apple Green Orange Blueberry Blue Lilac Green Wine Black Red Yellow



CALL US ON 01527 878348



VISIT WWW.FORWARDPRODUCTS.CO.UK



Concept Folding Tables and Stacking Benches

- Very popular aluminium framed tables with durable laminated tops
- Fold flat design for easy storage
- 5 year guarantee
- **Please see Important Furniture Ordering Information on page 306 before placing your furniture order**



Folding Tables		Size W x Dmm	Approx weight	A Buffet 76cm (30")	B Adult 70cm (27.5")	C Junior 64cm (25")	D Infant 58cm (23")	E PreSchool 55cm (21.5")	F Nursery 51cm (20")	1-4	5+
D211211	Rectangular	920 x 610	6.75kg		•	•	•	•	•	£84.25	£82.81
D211212	Rectangular	920 x 690	7.25kg		•	•	•	•	•	£86.31	£84.52
D211213	Rectangular	920 x 760	7.25kg		•	•	•	•	•	£89.44	£87.58
D211214	Rectangular	1220 x 610	8.00kg	•	•	•	•	•	•	£96.41	£94.40
D211215	Rectangular	1220 x 690	8.25kg	•	•	•	•	•	•	£98.82	£96.77
D211216	Rectangular	1220 x 760	9.50kg	•	•	•	•	•	•	£102.60	£100.47
D211217	Rectangular	1520 x 610	9.75kg	•	•	•	•	•	•	£103.55	£101.39
D211218	Rectangular	1520 x 690	10.25kg	•	•	•	•	•	•	£110.04	£107.75
D211219	Rectangular	1520 x 760	11.25kg	•	•	•	•	•	•	£113.87	£111.51
D211221	Rectangular	1830 x 480	11.00kg	•	•	•	•	•	•	£109.21	£106.95
D211222	Rectangular	1830 x 610	11.50kg	•	•	•	•	•	•	£120.13	£117.64
D211223	Rectangular	1830 x 690	12.00kg	•	•	•	•	•	•	£122.62	£119.35
D211224	Rectangular	1830 x 760	13.00kg	•	•	•	•	•	•	£126.58	£123.60
D211225	Round	Diameter 1220	20.00kg	•	•	•	•	•	•	£217.60	£212.00
D211226	Round	Diameter 1520	27.50kg	•	•	•	•	•	•	£253.80	£248.00

*Please specify height and top colour

Stacking Benches		Size W x Dmm	Approx weight	A Buffet 48cm (19")	B Adult 43cm (17")	C Junior 38cm (15")		
D211231	Rectangular	1220 x 250	5.00kg	•	•	•		£64.17 £62.84
D211232	Rectangular	1520 x 250	5.75kg	•	•	•		£72.50 £70.98
D211233	Rectangular	1830 x 250	6.75kg	•	•	•		£78.16 £76.54
D211234	Bench Skate Set		3.00kg					£79.52 £77.86

*Please specify height and top colour

Trolleys

- Save time and effort with these easy to use trolleys
- Easily pass through standard doorways
- Locking Castors

D211241	Trolley taking up to 7 Rectangular Tables	£239.57
D211242	Trolley taking up to 14 Rectangular Tables	£342.35
D211243	Trolley taking up to 6 Round Tables	£396.29

Please Specify:

1. Table/bench height
2. Table/bench colour

Concept Top & Bench Colour Options



PU Edge Tilt Top Dining Tables

- Comprehensive range of attractive multi-use tilt top tables, perfect where space is at a premium
- Easy to use tilt and close mechanism
- Advanced impact resistant, waterproof textured PU edges
- 4 lockable castors for safety
- 5 year guarantee
- 4 heights available giving flexibility for all age ranges
- **Please see Important Furniture Ordering Information on page 306 before placing your furniture order**



Octagonal Tilt Table - W1200mm

	Height(mm)	1-2	3-14	15+
D211251*	590	£252.61	£234.24	£229.64
D211252*	640	£252.61	£234.24	£229.64
D211253*	710	£252.61	£234.24	£229.64
D211254*	760	£252.61	£234.24	£229.64

* Please specify top colour, edge colour & frame colour



Irregular Octagonal Tilt Table - W1380 x D1000mm

	Height(mm)	1-2	3-14	15+
D211261*	590	£254.45	£235.94	£231.32
D211262*	640	£254.45	£235.94	£231.32
D211263*	710	£254.45	£235.94	£231.32
D211264*	760	£254.45	£235.94	£231.32

* Please specify top colour, edge colour & frame colour



Oval Tilt Table W1610 x D900mm

	Height(mm)	1-2	3-14	15+
D211271*	590	£346.14	£320.96	£314.67
D211272*	640	£346.14	£320.96	£314.67
D211273*	710	£346.14	£320.96	£314.67
D211274*	760	£346.14	£320.96	£314.67

* Please specify top colour, edge colour & frame colour



Medium Rectangular Tilt Table - W1200 x D900mm

	Height(mm)	1-2	3-14	15+
D211281*	590	£221.24	£205.15	£201.12
D211282*	640	£221.24	£205.15	£201.12
D211283*	710	£221.24	£205.15	£201.12
D211284*	760	£221.24	£205.15	£201.12

* Please specify top colour, edge colour & frame colour



Large Rectangular Tilt Table - W1500 x D900mm

	Height(mm)	1-2	3-14	15+
D211291*	590	£268.45	£248.93	£244.05
D211292*	640	£268.45	£248.93	£244.05
D211293*	710	£268.45	£248.93	£244.05
D211294*	760	£268.45	£248.93	£244.05

* Please specify top colour, edge colour & frame colour



Circular Tilt Table - D1200mm

	Height(mm)	1-2	3-14	15+
D211311*	590	£250.06	£231.87	£227.33
D211312*	640	£250.06	£231.87	£227.33
D211313*	710	£250.06	£231.87	£227.33
D211314*	760	£250.06	£231.87	£227.33

* Please specify top colour, edge colour & frame colour

Please Specify:

1. Top colour
2. Edge colour
3. Frame colour

Laminate Top Colours



PU Edge Information:

Incredibly tough, PU edging is moulded to the MDF core meaning that it cannot be prised or picked away

PU Edge Colours



Frame Colours



Speckled Grey will be supplied if no colour is specified



CALL US ON 01527 878348



VISIT WWW.FORWARDPRODUCTS.CO.UK



Frontier Tables - Bases

- Sturdy range of table bases
- Choose from stylish stainless steel or black slimline design
- See following page for the accompanying tops
- Adjustable feet suitable for most floor finishes
- 3 year guarantee
- **Please see Important Furniture Ordering Information on page 306 before placing your furniture order**

Please call to book a site consultation

See next page for top options

Dining Bases 730mm high



D211321



D211322



D211323



D211324

Poseur Bases - 1050mm High



D211325



D211326



D211327



D211328

Code	Base Type	Base Width	Max. Top Sizes		Price
			Round	Square	
D211321	Dining Base - Medium Black	450mm	900mm	700 x 700mm	£93.00
D211322	Dining Base - Large Black	600mm	1300mm	1000 x 1000mm	£133.36
D211323	Dining Base - Medium Stainless Steel	460mm	800mm	700 x 700mm	£126.05
D211324	Dining Base - Large Stainless Steel	600mm	1200mm	1100 x 1100mm	£176.10
D211325	Poseur Base - Medium Black	450mm	900mm	700 x 700mm	£100.57
D211326	Poseur Base - Large Black	600mm	1300mm	1000 x 1000mm	£140.93
D211327	Poseur Base - Medium Stainless Steel	460mm	800mm	700 x 700mm	£133.36
D211328	Poseur Base - Large Stainless Steel	600mm	1200mm	1100 x 1100mm	£183.67



Frontier Tables - Tops

- Hardwearing range of tops to go with Frontier bases on previous page
- Tested for severe contact use
- Other sizes and colours also available, please call for details
- **Please see Important Furniture Ordering Information on page 306 before placing your furniture order**



Call for
free
samples



Laminated Tops

- 25mm durable laminated tops
- Scratch resistant and heat resistant to 180°F
- 6 attractive colours
- Other sizes and colours also available, please call for details

Square Tops

D211331	500 x 500mm	£49.24
D211332	600 x 600mm	£57.89
D211333	700 x 700mm	£75.47
D211334	800 x 800mm	£86.02
D211335	900 x 900mm	£101.33

Rectangular Tops

D211341	1000 x 500mm	£55.13
D211342	1000 x 600mm	£70.87
D211343	1100 x 700mm	£124.27
D211344	1200 x 600mm	£100.90
D211345	1200 x 700mm	£124.97
D211346	1200 x 800mm	£125.78

Circular Tops

D211351	600mm Diameter	£64.76
D211352	700mm Diameter	£87.59
D211353	800mm Diameter	£108.15
D211354	900mm Diameter	£124.97
D211355	1000mm Diameter	£150.13
D211356	1200mm Diameter	£174.21

Laminated Top Colour Options

Please Specify:

Top colour



Beech



Oak



Walnut



Wenge



White



Black

Premium Moulded Tops

- Extremely durable table tops with a completely sealed moulded edge
- Suitable for indoor and outdoor use
- 10 stylish colour options
- Please call for colour samples
- **Please see Important Furniture Ordering Information on page 306 before placing your furniture order**

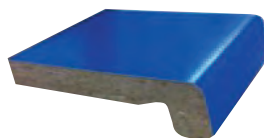

Other sizes
and colours
available -
please call for
options

Square Tops

D211361	600 x 600mm	£62.38
D211362	700 x 700mm	£80.01
D211363	800 x 800mm	£94.95

Rectangular Tops

D211371	1100 x 700mm	£119.57
---------	--------------	---------

Circular Tops

D211381	600mm Diameter	£55.08
D211382	700mm Diameter	£67.91
D211383	800mm Diameter	£75.55

Please Specify:

Top colour

Moulded Top Colour Options



City



Arizona



Blanc



Noir

Premium Moulded Top Colour Options (price POA)



Alu



Orange



Rouge



Vert



Cassis



Wenge

* Not available in 1200mm diameter circular ** Not available in 900mm, 1000mm or 1200mm diameter circular



CALL US ON 01527 878348



VISIT WWW.FORWARDPRODUCTS.CO.UK



Chill Primary Canteen Table & Bench Sets

Fantastic solution for primary school dining.

- Available in sizes to suit infant and junior schools
- Encourages communal dining
- Solid 18mm MDF tops with a high pressure laminate finish and durable PU edges
- Each code is one set which includes one table and two benches
- Chunky 30mm crushed bent frame
- Stackable up to 3 high
- Three tables and six benches neatly stack away when not in use
- Made in the UK with a 5 year warranty

	Table Dimensions (mm) L x W x H	Bench Dimensions (mm) L x W x H	
Infant Height			
D212391*	1600 x 750 x H530	1400 x 300 x H310	£515.32

	Table Dimensions (mm) L x W x H	Bench Dimensions (mm) L x W x H	
Junior Height			
D212392*	1600 x 750 x H640	1400 x 300 x H380	£515.32

* Please specify top colour, edge colour, frame colour & bench colour

Each set includes 1 Table and 2 Benches

Please Specify:

1. Top colour
2. Edge colour
3. Frame colour
4. Bench vinyl colour

Laminate Top Colour



PU Edge Colours

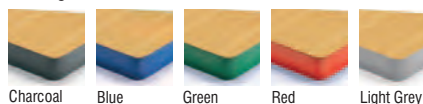

Frame colour - supplied in speckled light grey if not specified



Bench Vinyl Colour



*Silver frame available at an extra cost.





Groove Secondary Canteen Table & Bench Sets

- Stylish & robust 25mm white laminated tops with white BURO edge
- Chunky 40 x 40mm box frame
- Vibrant choice of frame colours available
- Each code is one set which includes one table and two benches
- Benches store underneath the table for a tidy environment



Code	Table Dimensions (mm)	Bench Dimensions (mm)	
	L x W x H	L x W x H	
D212393*	1600 x 800 x H760	1400 x 400 x H450	£588.09
D212394*	1800 x 800 x H760	1600 x 400 x H450	£628.35
D212395*	2000 x 800 x H760	1800 x 400 x H450	£687.25
D212396*	2200 x 800 x H760	2000 x 400 x H450	£749.51

* Please specify frame colour

Each set includes 1 Table and 2 Benches

Please Specify:

1. Frame colour

Frame Colour



Pastel Orange

Pastel Violet

Soft Blue

Soft Lime

Tangy Green

Telemagenta

Turquoise

Laminate Top Colour



White

BURO Edge Colour



White



CALL US ON 01527 878348



VISIT WWW.FORWARDPRODUCTS.CO.UK



Switch Chair and Stool

- Stylish polypropylene breakout chair with robust chrome-plated steel frame
- Fibreglass reinforced seat and back
- Additional upholstered seat pad available
- Chairs stack 8 high and stools stack 4 high
- 5 year guarantee
- **Please see Important Furniture Ordering Information on page 306 before placing your furniture order**

Switch Chair

- W540 x D450 x SH460mm

		1-5	6-29	30+
D211481	Switch Chair	£60.34	£58.38	£56.41

Switch Stool

- W500 x D500 x SH760mm

		1-5	6-29	30+
D211482	Switch Stool	£111.51	£107.88	£104.24

Extras - Upholstered Seat Pad

- Price based on Advantage fabric, see page 258 for options

		1-5	6-29	30+
D211483		£40.74	£37.77	£36.50



Please Specify:

Seat colour



Dream Chair

- Elegant new polypropylene chair with ergonomically shaped back
- Stackable up to 8 high
- Robust construction - tested for heavy contact use
- Suitable for indoor and outdoor use
- **Please see Important Furniture Ordering Information on page 306 before placing your furniture order**

		1-5	6-29	30+
D211491	Dream Chair	£62.10	£57.75	£55.27



Please Specify:

Seat colour





Maestro Chair

- Durable, flexible and ergonomic high density seating for stimulating spaces
- Contemporary and comfortable, perfect for halls, cafeterias, libraries and classrooms
- 10 year guarantee
- Stacks 38 high on transport dolly
- Chrome frame
- Seat pad price is for Advantage fabric, please see page 258 for options
- **Please see Important Furniture Ordering Information on page 306 before placing your furniture order**



		1-5	6-29	30+
D211501	Maestro Chair	£75.55	£72.05	£69.95
D211502	Upholstered Seat Pad	£25.76	£24.80	£24.57
D211503	Transport Dolly	£236.63	n/a	n/a



Please Specify:

Seat colour



CALL US ON 01527 878348



VISIT WWW.FORWARDPRODUCTS.CO.UK



Breeze Chair

- Durable and comfortable, the Breeze is an exciting dining and breakout chair
- Made from UV resistant reinforced polypropylene
- Stacks up to 10 high
- Tested to EN1729 parts 1 and 2
- 5 year guarantee
- W500 x D510 x SH460mm

		1-5	6-29	30+
D211521	Breeze Chair	£52.68	£46.89	£44.78

Please Specify:

Seat colour

Breeze Chair Colour Options



Swing Chair

- Modern new breakout chair range with unique features
- 2 base options to suit numerous applications
- 4 leg and skid frame chairs have heavy duty chrome stackable frames
- 2 year guarantee
- Tested for severe contact use
- 8 eye-catching colours available



Swing Four Leg

- W580 x D510 x SH450mm

	1-5	6-29	30+
D211532	£68.43	£63.95	£58.19

Swing Skid Frame

- W580 x D510 x SH450mm

	1-5	6-29	30+
D211531	£73.13	£68.35	£62.20

Please Specify:

Seat colour

Swing Chair Colour Options



Please see Important Furniture Ordering Information on page 306 before placing your furniture order





Curve Dining Chair

- Attractive plywood shell chair with solid chrome plated frame
- Beech finish supplied as standard, other finishes available, see bottom of page
- 3 year guarantee
- Protective rubber feet for hard floors
- Stackable up to 4 high
- W500 x D460 x SH450mm

		1-5	6-29	30+
D211561	Stain Finish	£66.32	£61.68	£59.02
D211562	Laminate Finish	£97.41	£90.59	£86.69

Please see Important Furniture Ordering Information on page 306 before placing your furniture order



Standard Beech Stain



Beech Stacked



Zebrano Laminate



Special Polyrey Laminate

Curve Stool

- Sleek bar stool to match Curve chair
- Chrome plated skid base with footrest and rear frame support
- Beech finish supplied as standard, see below for further colour options
- 3 year guarantee
- Protective anti-skid feet
- W532 x D524 x SH745mm

		1-5	6-29	30+
D211571	Stain Finish	£131.37	£122.18	£116.92
D211572	Laminate Finish	£158.61	£147.50	£141.16



Please Specify:

Seat colour

Standard Stain Colours



Premium Laminate Colours**

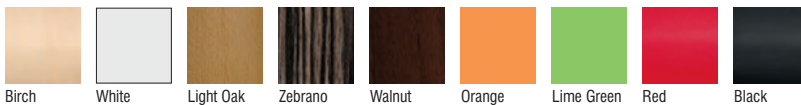

*Beech supplied as standard
 **Other colours available.
 Please call for details



CALL US ON 01527 878348



VISIT WWW.FORWARDPRODUCTS.CO.UK



21

Fabrics

Advantage	561
Main Line Plus	562
Blazer	563
Aquarius	564
Linetta	565
Corrosion & Code	566
Just Colour Vinyl	567
Vita Vinyl	568
Cara Screen	569
Lucia Screen	570

Advantage - Standard Fabric for Office Chairs and Conference Chairs

- Advantage is the UK's top selling Low Hazard seating fabric
- Its high performance durability comes from its blend of 30% wool and 70% gymlene - a synthetic fibre originally developed for use in broadloom carpets
- It is rated at 75,000 Martindale abrasion cycles

For a wider range of fabric options, please call us today.

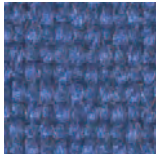

Adriatic

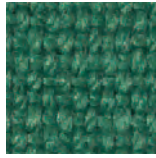

Aqua

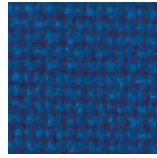

Cobalt

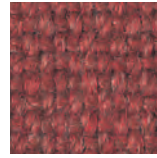

Cranberry

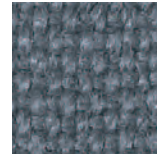

Granite

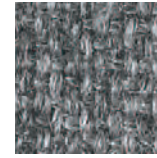

Mineral



Nightshade

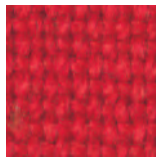

Red



Sandvale

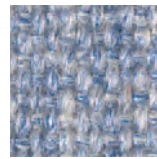

Sea Blue

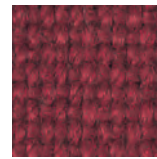

Wine

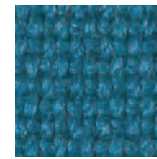

Delta Blue



Turquoise

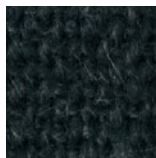

Charcoal



Grape

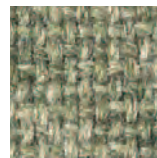

Leaf



Black



Graphite



Pewter



Damson

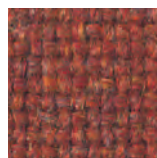

Tawny

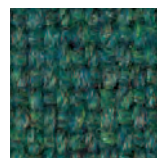

Persian

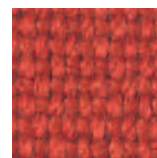

Cinnamon

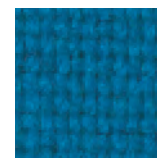

Largo

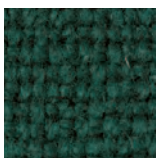

Aztec

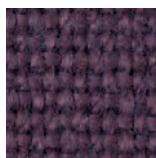

Beetroot

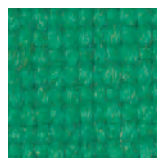

Oasis



Purple



Fox

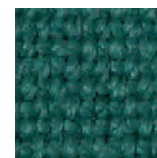

Teal



Shamrock

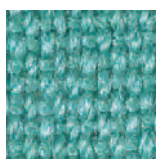

Kingfisher

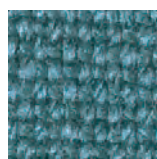

Riviera



Trident



Fjord



Clipper



Raspberry



Peat

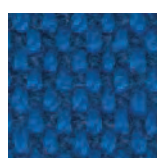

Hobbit



Trent

- Flammability: Low hazard BS 7176.
- Abrasion resistance: 75,000 cycles.
- Composition: 30% pure new wool, 70% gymlene.
- Maintenance: Vacuum regularly, wipe clean with a damp cloth.
- Colour Matching: Batch to batch variations in shade may occur within commercial tolerance.

Due to limitations in the printing process when fabric is shown photographically, we recommend that you ask for actual fabric samples before ordering.



Mainline Plus - Standard Fabric for Sofas and Soft Seating

- One of the most popular seating fabrics in the Camira collection which has sold over 30 million metres since launch
- Available in an extensive colour palette, this versatile plain weave fabric gives a smart appearance to most seating styles



Due to limitations in the printing process when fabric is shown photographically, we recommend that you ask for actual fabric samples before ordering.



CALL US ON 01527 878348



VISIT WWW.FORWARDPRODUCTS.CO.UK

Blazer - Premium Fabric for All Seating Ranges - Add 35% to Prices

- Blazer is a pure new wool upholstery fabric with a billiard cloth felted finish
- Created from 100% Laneve branded wool, its origin can be traced back to the individual sheep farms on South Island, New Zealand. Laneve promises wool integrity and complete chain of custody
- Blazer is certified to the EU Ecolabel



Due to limitations in the printing process when fabric is shown photographically, we recommend that you ask for actual fabric samples before ordering.



Aquarius - Premium Fabric for all Seating Ranges - Add 35% to Prices

- Aquarius is a tried and tested, versatile crepe weave fabric that is suitable for task chairs and soft seating
- It's made from 100% natural wool, which is not only rapidly renewable but also fully bio-degradable
- The colour palette offers a great balance of subdued organic shades and confident brights



Due to limitations in the printing process when fabric is shown photographically, we recommend that you ask for actual fabric samples before ordering.



CALL US ON 01527 878348



VISIT WWW.FORWARDPRODUCTS.CO.UK

Linetta – Anti-Microbial Fabric for All Seating Ranges – Add 15% to Prices

Linetta is anti-microbial, bleach cleanable, stain resistant and waterproof. It has also been tested and is effective against viruses including Covid-19! This is through a protection system called 'Aguaguard 365'

Specifications:

- Flame retardant - BS7176 Crib 5, BS EN 1021-1:2006 1&2, BS5852 Crib 5, IMO Annex 1 Part 8.
- Anti-bacterial/Anti-fungal - Resistant to microbial or fungal growth including Salmonella, E Coli and MRSA.
- Waterproof - Hydrostatic Head BS3424 > 1 metre.
- Martindale - Severe Contract > 100,000.
- Stain resistant - Excellent stain removal has been observed for grease, ink, blood, urine, coee, iodine, betadine, ketchup, chewing gum, chocolate, grape juice.
- Composition - 100% Treated polyester.
- Breathable - Moisture vapour permeable.

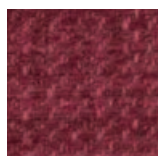

Plum

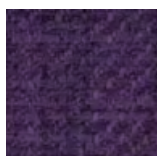

Violet



Silver



Light Grey



Slate



Cream



Salmon



Olive



Grape



Mint



Light Blue



Steel



Nutmeg



Sand



Burnt Orange



Lime



Purple



Duck Egg



Denim



Charcoal



Truffle



Gold



Red



Orchid

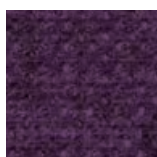

Damson

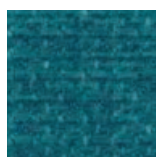

Teal

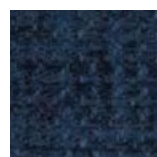

Midnight

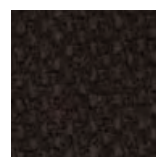

Black

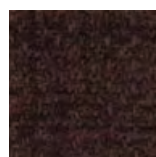

Chocolate



Mustard

Linetta uses state of the art anti-bacterial fabric technology Aguaguard 365

- A safe anti-bacterial protection system for upholstery fabrics, effective against viruses including Covid-19. Whilst research indicates viruses and bacteria survive longer on hard surfaces, soft surfaces like textiles can provide a large hosting area and benefit their carryover.
- It is comprised of a patented and registered silver technology (small silver particles are potent antibacterial and antiviral agents) and a pending patent fatty vesicle technology that acts as a booster to the silver technology that physically destroys viruses.

AguaGuard365 is:

- Harmless to the skin and body and uses a minimum of active ingredients
- EU BPR (Biocidal Products Regulation) and EU REACH compliant.
- Carries Bluesign, EPA, OekoTex and ZDHC (Zero Discharge Of Hazardous Chemicals) approval and certification.

Due to limitations in the printing process when fabric is shown photographically, we recommend that you ask for actual fabric samples before ordering.



Corrosion - Premium Fabric for All Seating Ranges - Add 45% to Prices

- Printed onto wool blend fabric, Synergy, the rusting surface of Corrosion is broken up with geometric triangles, exploring the mix of negative space, rust and hard cut shapes.



Task seating



Soft seating



Cigarette & Match



Year guarantee



Etch



Entropy



Oxidise



Tarnish

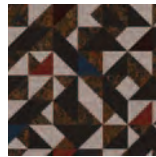

Enrich



Erode

Code - Premium Fabric for All Seating Ranges - Add 45% to Prices

- Code is a luxurious worsted wool reminiscent of the old Savile Row suiting cloths updated for today's digital age
- The fabric echoes modern technology by featuring barcode inspired stripes which run horizontally across the fabric due to the large pattern repeat
- The range presents darker, explorative shades alongside bright, bold and playful colours



Task seating



Soft seating



Cigarette & Match



Year guarantee

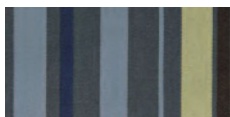

Scanner



Dots



Matrix



Dash



Data

Due to limitations in the printing process when fabric is shown photographically, we recommend that you ask for actual fabric samples before ordering.



CALL US ON 01527 878348



VISIT WWW.FORWARDPRODUCTS.CO.UK

Just Colour Vinyl - Vinyl for All Seating Ranges - Add 15% to Prices

Just Colour harmonizes with both contemporary and traditional interiors. The broad palette encompasses modern neutrals, warm classics to vivid bright colours.

Designed to withstand the rigorous demands of both heavy domestic and contract upholstery, Just Colour is suitable for a wide variety of applications.

- Flame Retardancy: BS5852 Ignition Source 5, BS7176 Medium Hazard, S.I. 1988 No. 1324 schedule 4&5, EN1021-1&2, CS-25, FMVSS 302 and IMO 2010 FTP CODE ANNEX 1 PART 8
- Abrasion: 1,000,000 Martindale rubs
- Antimicrobial and antifungal, independent testing has verified that Just Colour is effective at reducing the spread of MRSA, E.coli and other similar bacteria and fungi
- 3 year warranty



Due to limitations in the printing process when fabric is shown photographically, we recommend that you ask for actual fabric samples before ordering.



Vita Vinyl - Vinyl for All Seating Ranges - Add 15% to Prices

- Vita is a leather-look vinyl, with a subtle surface grain effect and full matt appearance
- It provides maximum protection for heavy duty end-use areas in sectors such as contract, healthcare and public transport
- It is available in a broad palette of 23 considered colourways
- Vita does not contain phthalate plasticisers or heavy metals, yet remains soft, stretchy and pliable
- Vita's special and highly durable top coat is suitable for cleaning with soapy water and upholstery shampoo, and will also stand up to bleach or alcohol cleaners for maximum hygiene
- 5 year warranty



Due to limitations in the printing process when fabric is shown photographically, we recommend that you ask for actual fabric samples before ordering.



CALL US ON 01527 878348



VISIT WWW.FORWARDPRODUCTS.CO.UK

Cara Standard Screen Fabric

- Cara is a plain weave panel fabric available in 32 commercial colourways
- One of our most popular vertical surface fabrics
- Cara is used extensively on desk screens, wallsides and on pin board



Spray



Ronay



Dolphin



Carron



Galilee



Inverness



Fair Isle



Adriatic

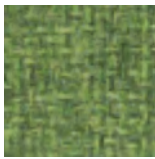

Staffa



Easdale



Lossie



Tummel



Lora

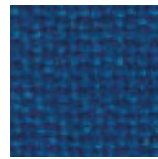

Cluanie



Walton

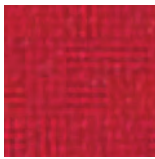

Pitlochry



Vit



Glass



Lomond

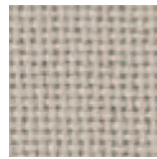

Shetland



Hillswick



Beltane



Chaucer

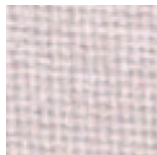

Clan

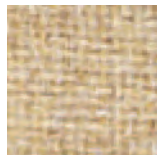

Austen

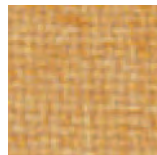

Maree



Portland

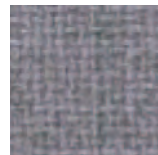

Denny



Lerwick



Merrick



Lead

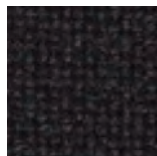

Black

Due to limitations in the printing process when fabric is shown photographically, we recommend that you ask for actual fabric samples before ordering.



Lucia - Premium Screen Fabric - Add 10% to Prices

- An ever popular crepe weave synthetic panel fabric
- Manufactured from 100% recycled polyester saving virgin raw materials and for a reduced environmental footprint. With a non lustrous appearance, it has a bold and bright colour palette
- Lucia is certified to the EU Ecolabel

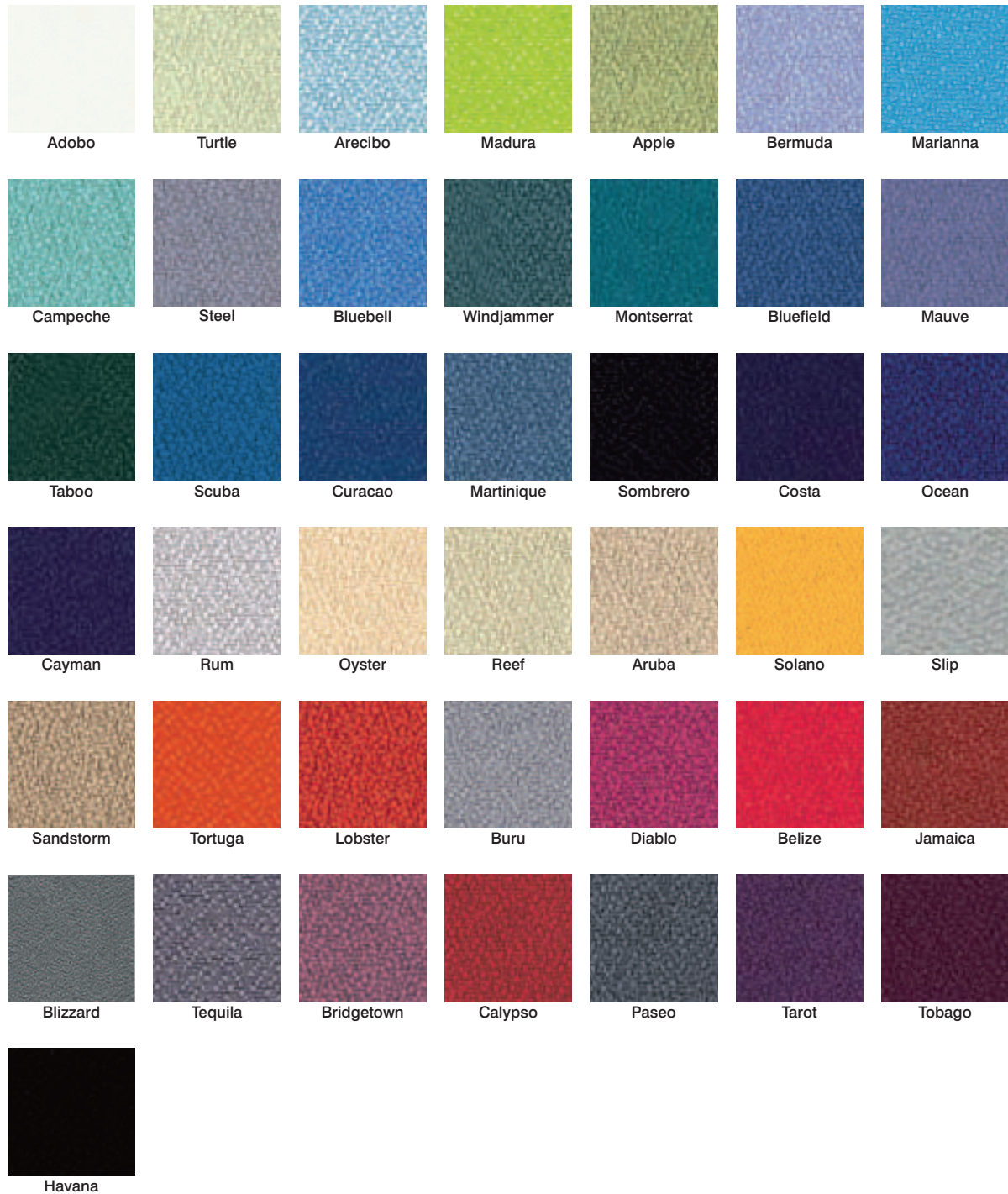

Due to limitations in the printing process when fabric is shown photographically, we recommend that you ask for actual fabric samples before ordering.



CALL US ON 01527 878348



VISIT WWW.FORWARDPRODUCTS.CO.UK

FURNITURE INDEX

A

A3 Paper Storage Unit.....	376
Adjustable Height Tables.....	348,352, 388-389,487-488
Art Storage Units.....	375-376

B

Back Care Seating.....	441-442
Barriers.....	398
Bean Bags.....	393,470
Beech Cantilever Furniture... 475-480,526	
Beech Tables & Chairs.....	387-388, 473-483,487-489,507-521,526-527
Bench Desking.....	481-484
Big Book Holder.....	390
Bin Storage.....	390
Boardroom Tables.....	507,513-518
Bookcases.....	359,369,372,374, 390,501,504,529
Breakout Seating.....	391-392, 463-465,467-468

C

Cabinets

Filing.....	504,528,529,533-534,540
First Aid.....	422
Key.....	422
Cable Management.....	484,488,492
Café Seating.....	555-558
Cantilever Chairs.....	314,325-326, 432,435,437,440,443-444,447-449
Cantilever Desking.....	475-480,526
Carrel Units.....	352
Certificate Frames.....	419
Chair Trolley.....	318,320,447,556

Chairs By Name

Abele.....	447
Abingdon.....	449,450
Aero Stool.....	325
Affinity.....	317
Ascott.....	449
Atlanta.....	433,464
Balmoral.....	440
Bianca.....	448
Brodsworth.....	449

Carlisle.....	429
Castelo.....	433
Catania.....	443
Classic.....	321,328
Conquest.....	440
Dumbell.....	309
Eco.....	317
Elegance.....	439
EN One Piece Polypropylene.....	313
EN Polypropylene.....	314
Ergoform.....	323
Excel.....	437-438
Fyvie.....	432
Giovanni.....	439
Harlech.....	427
Helmsley.....	431
Hype.....	318,322,328
Inspire.....	319
Lorenzo.....	450
Maestro.....	556
Miranda.....	428
Modena.....	448
Penrith.....	436
Postura Plus.....	310
Rochester.....	436
Sevilla.....	446
Stockholm Posture.....	441
Stokesay.....	434
Storm.....	316,328
Swivel.....	321-322,427-442
Titan High Chair.....	327
Titan One Piece Polypropylene... 311	
Titan Polypropylene.....	312,322
Toledo.....	431
Trebuchet.....	442
Valencia.....	445
Vaneto.....	430
Venice.....	444
Verona.....	444
Vigo.....	445
Vita.....	443
Wentworth.....	435
Whitley.....	429
Zing Stool.....	326

Chairs By Type

Back Care Range.....	441-442
Breakout Seating.....	391-392, 463-465,467-468
Cantilever.....	314,325-326,432, 435,437,440,443-444,447-449

Classroom.....	307-329
Conference Chairs.....	443-450,525
Dining.....	553-558
Early Years.....	388,391-394
Fabric Ranges.....	559-570
Folding.....	320
High Chairs.....	327-329
IT Chairs.....	321-322
Manager Swivel.....	439-440
Meeting.....	443-450
Mesh Back Swivel....	428,433,435,437
Modular.....	453-457,465-467
One Piece Polypropylene..	310,311,313
Operator.....	427-432,525
Pouffe.....	393,394,453-454,462
Skid Base Classroom.....	310,312, 314,316
Sofas.....	455-456, 459-460,462-468
Soft.....	451-470
Stacking.....	310,311,313,315-319,556
Stools.....	323-327
Tamperproof IT.....	321
Task.....	430,433-439,442
Tub Chairs.....	459-462
Classroom Chairs.....	307-329
Classroom Furniture.....	307-394
Classroom Stools.....	323-327
Classroom Storage Units.....	384-384
Classroom Tables.....	330-353
Craft.....	345-346
Crushbent Frame.....	331-334,337
Early Years.....	338,387-389
Exam Desks.....	351
Express Delivery Tables.....	336
Flower Shaped.....	389
Heavy Duty.....	341-342
Height Adjustable.....	348
Locker Top Desks.....	349
MDF Edge.....	331-332, 335-336,345-346,348-349,351
Premium.....	337-351, 346-348,351
Project.....	345-346
PU Edge.....	333-334,338-341,347
Shaped.....	343-344,388-389
SmartTop Desks.....	353
Study Carrels.....	352
Teacher's Desks.....	350
Themed.....	389
Tray Tables.....	335



Welded Frame.....	331-336, 338-310,345-346
Cloakroom Equipment & Benches.....	381,392,541-544
Clocks.....	421,422
Coat Hooks.....	381,392
Coat Peg Units.....	381,392
Coffee Tables.....	456,460,466,519-522
Coloured Edge Storage Units.....	371-372
Conference Furniture....	443-450,507-518
Conference Seating.....	443-450,525
Conference Tables.....	507-508,513-18
Covid Testing Booths & Pods.....	397, 399-400
Craft Tables.....	345-346
Crushbent Frame Tables.....	331-334, 337,345

Cupboards

Art.....	375-376,380
Classroom Double Door.....	360, 364,370,372
Coloured Edge.....	372
Dressing Up.....	380
Fire Resistant.....	540
Glass Door.....	499,501-502
Lockable Wooden.....	364,370,372
Office.....	499-505,529
Safes.....	539
Sliding Door.....	368,499,501
Steel Lockable.....	530,535,540
Tambour Cupboards.....	505,530,536
Steel.....	530,535-536,540
Tray Storage.....	357-368,371,373-383
Wooden.....	360,364,370, 372,499-505
Wooden Lockable.....	364,370,372

D**Desks/Desking**

Accessories.....	491-494
Bench Desking.....	481-484
Cantilever.....	475-480,526
Classroom.....	349,350,351
Craft.....	345-346
Exam.....	351
Flip Top.....	351,511,549
Folding.....	351,511,549
Height Adjustable.....	348,487-488
Locker Top.....	349
Meeting Ends.....	489
Panel End.....	473-474,527
Screens.....	398,401-402,495-498
Teacher's.....	350
Tilt Top.....	351,511,549

Dining

Chairs.....	555-558
Folding Tables.....	547-550
Folding Stool Tables.....	547-548
Poseur Tables.....	551-552
Stools.....	555,558
Table Bases & Tops.....	551-552
Table & Bench Sets.....	553-554
Tilt Top Tables.....	347,550
Display Kits, Light.....	420
Double Door Cupboards.....	360,364,370, 372,499-505,529-530,535-536,540
Dressing Up Cupboard.....	380
Drywipe	
Boards.....	405-412,419
Easels.....	409-410
DT Workbenches.....	353

E**Early Years**

Chairs.....	388,391-394
Seating.....	388,391-394
Storage.....	390
Tables.....	387,388,389
Easels, Drywipe.....	409-410
EN One Piece Polypropylene Chair.....	313
EN Polypropylene Chairs.....	314
Exam Chairs.....	320
Exam Desks.....	351
Executive Conference Seating.....	449
Executive Office Seating.....	439-440
Express Delivery Tables.....	336,526-527

Express Ranges

Chairs.....	525
Desks.....	526-527
Filing.....	528-530
Storage.....	529-530

F

Fabric Swatches.....	559-570
Filing Cabinets - Steel.....	529, 533-534,540
Filing Cabinets - Wooden.....	504,528
Fire Resistant Cupboards.....	540
Fire Resistant Filing Cabinets.....	540
Fire Resistant Safes.....	539
First Aid Cabinets.....	422
Fixed Pedestals.....	486,528
Flip Top Tables.....	347,512,550
Floor Standing Screens.....	495-496
Folding Benches.....	547-549
Folding Chairs.....	320

Folding Tables.....	351,511,549
---------------------	-------------

G

Gratnells Trays.....	356
Gratnells Tray Storage Units.....	357-368, 371,373-374,376-383

H**Healthcare**

Barriers.....	398
Covid Testing Pods.....	397
Screens.....	398,401-4029
Testing Booths.....	399-400
Heavy Duty Classroom Tables.....	341-342
Height Adjustable Tables.....	348,487-488
High Chairs.....	327-329

I

Interior Plants.....	423-424
IT Desking.....	352,353
IT Seating.....	321-322

J

Jumbo Tray Storage Units.....	365
-------------------------------	-----

K

Key Cabinets.....	422
-------------------	-----

L

Laptop Storage & Charging Units.....	384
Library Storage Unit.....	378-380
Light Display Kits.....	420
Linked Benching.....	481-484
Lockable Cupboards.....	360,364,370, 372,499-505,529-530,535,540
Locker Top Desks.....	349
Lockers.....	378,541-544

M

Magnetic Whiteboards.....	405,406, 409-412
Manager Seating.....	439-440,449
Maple Storage.....	377-381



MDF Edge Tables..... 331-332,335-336,
345-346,348-349,351
Meeting Chairs..... 443-450
Meeting Tables..... 507-518
Mesh Back Swivel Chairs..... 428,433,
435,437
Metal Classroom Storage Units... 382-384
Mobile Pedestals..... 485,528,530,538
Mobile Tray Storage Units..... 357-363,
365-368,371,373-374,376-380,383
Modular Seating..... 453-457,465-467
Modular Breakout Seating..... 453-454,
465,467
Modular Storage Units..... 373-374
Modular Tables..... 343-344
Multidrawer Units..... 534

N

Noticeboards

Combination..... 419
Cork..... 417,419
EcoColour..... 415-416
Framed..... 413,414-416
Magnetic..... 417
Tamperproof..... 413,414-416
Unframed..... 413,414-416

O

Office Accessories..... 403-424
Office Chairs..... 425-442,525

Office Furniture

Back Care Seating..... 441-442
Bench Desking..... 481-484
Boardroom Tables..... 507,508,
513-518
Bookcases..... 501,504,529
Cable Management..... 484,488,492
Cantilever Desking..... 475-480,526
Coffee Tables..... 456,460,466,519-522
Conference Chairs..... 443-450,525
Conference Tables..... 507-518
Cupboards..... 499,501,502-505,
529,530,535-536,540
Desking..... 473-483,487-489,526-527
Executive..... 439,440,449,477-480
Fabric Ranges..... 559-570
Filing Cabinets - Steel..... 529,
533-534,540
Filing Cabinets - Wooden..... 504,528
Flip Top Tables..... 347,512,550
Lockers..... 541-544

Manager Swivel Chairs..... 439-440
Mesh Back Swivel Chairs..... 428,433,
435,437
Meeting Ends..... 489
Meeting Chairs..... 443-450,525
Meeting Tables..... 507-518
Modular Chairs..... 453-457,463-467
Multidrawer Units..... 534
Operator Chairs..... 427-432,525
Panel End Desking..... 473-474,527
Pedestals..... 485-486,528,
530,538
Pigeon Hole Units..... 490,502
Plants..... 423-424
Screens..... 398,401-402,495-498
Side Filer Units..... 500,528
Sofas..... 455-456,459-460,462-468
Steel Cupboards..... 530,535-536,540
Steel Pedestals..... 530,538
Swivel Chairs..... 427-442
Tables..... 487-488,507-522
Tambour Cupboards..... 505,530
Task Chairs..... 430,433-439,442
Training Tables..... 509-512
Tub Chairs..... 459-462
Office Plants..... 423-424
Office Soft Seating..... 425-470
Operator Chairs..... 427-432
Outdoor Plants..... 424

P

Panel End Desking..... 473-474,527
Paper Storage Units..... 375-376
Pedestals..... 485-486,528,530,538
Pen Trays..... 491
Photo & Certificate Frames..... 419
Pigeon Hole Units..... 490,502
Plants..... 423-424
Polypropylene Classroom Chairs... 310-319,
323-328
Poster Frames..... 419
Postura Plus Chairs..... 310
Posture Seating..... 310,441-442
Pouffes..... 393,394,453-454,462
Premium Classroom Tables..... 337-343,
346-348,351
Premium Tray Units..... 357-360
Project Table..... 345-346
PU Edge Tables..... 333-337,339-348
Puzzle Tables..... 344

R

Reading & Writing Centre..... 412
Reception Seating..... 453-469

S

Safes..... 539
Screens..... 398,401-402,495-498

Seating:

Bean Bags..... 393,470
Beech..... 388
Breakout..... 391-392,463-465,
467-468
Café..... 555-558
Classroom..... 307-329
Conference Chairs..... 443-450
Dining..... 547-548,553-558
Early Years..... 388,391-3941
EN Chairs..... 313-314
Fabric Ranges..... 559-560
Folding..... 320
High Chairs..... 327-328
IT Chairs..... 321-322
Manager Swivel Chairs..... 439-440
Meeting Chairs..... 443-450
Mesh Back Swivel Chairs..... 428,
433,435,437
Modular..... 453-457,465-467
Postura Plus Chairs..... 310
Pouffe..... 393,394,453-454,462
Operator Chairs..... 427-432,525
Segment..... 394,453-454,456
Sofas..... 455-456,459-460,462-468
Soft..... 451-470
Staffroom..... 455-468
Stools..... 309,310,323-327,
462,548,555,558
Stools - Dining..... 555,558
Swivel Chairs..... 321-322,427-442,525
Task Chairs..... 430,433-439,442
Titan Chairs..... 311,312,322
Titan High Chair..... 327
Tub Chairs..... 459-462
Shaped Tables..... 343-344,388-389
Shockbox Lockers..... 543
Side Filer Units..... 500,528

Sienna Range

Accessories..... 491-494
Bench Desking..... 481-484
Coffee Tables..... 519-521
Conference Tables..... 513-518
Desking..... 473-480
Flip Top Tables..... 512
Meeting Ends..... 489



Meeting Tables..... 507-508
 Pedestals..... 485-486
 Storage..... 499-506
 Training Tables..... 509-512
 Skid Base Chairs..... 310,312,314,316,
 443,458,469,558
 Sliding Door Cupboard..... 368,499,501
 Snap Display Poster Frames..... 419
 Sofas..... 455-456,459-460,462-468
 Spectrum Heavy Duty Table..... 341-342
 Stacking Chairs - Classroom..... 310,
 311,313,315-319
 Stacking Chairs - Conference.....443-447,
 525
 Staffroom Seating..... 455-468
 Steel Cupboards..... 530,535-536,540
 Steel Lockers..... 541-543
 Steel Pedestals..... 529,530,538
 Steel Storage Accessories..... 537
 Steel Storage..... 529-542
 Stools - Dining..... 555,558
 Stools..... 323-327,555,558

Storage

Art..... 375-376
 Bookcases..... 359,369,372,374,
 390,501,504,529
 Classroom..... 356-384
 Coloured Edge..... 371-372
 Cupboards..... 360,364,370,372,380,
 499-505,529,530,535-537,540
 Early Years..... 390
 Filing Cabinets - Steel..... 529,530,
 533-534,540
 Filing Cabinets - Wooden..... 504,528
 Glass Door Cupboard..... 499,501-502
 Gratnells Trays & Units..... 355-368,
 371,373-374,376-383
 Jumbo Tray Units.....365
 Library.....378,390
 Lockable Wooden Cupboards..... 364,
 370,372
 Lockers..... 378,541-544
 Maple Range..... 377-381
 Metal Tray Units..... 382-383
 Mobile Bin.....390
 Mobile Tray Unit..... 357-363,
 365-368,371,373-380,383
 Multidrawer Units..... 534
 Pedestals..... 485-486,528,
 530,538
 Pigeon Hole Units..... 490,502
 Safes..... 539
 Sliding Door Cupboard.....368,499,501
 Steel Cupboards..... 530,535-536,540
 Tambour Cupboards.....502,
 505,530,536

Tray Storage Units..... 355-368,371,
 373-383
 Wooden Lockable Cupboards.... 360,
 364,370,499-505,529
 Study Carrel Units..... 352
 Swivel Chairs..... 321-322,427-442,525

T

Tables

Bases & Tops..... 551-552
 Beech..... 387-388,473-483,
 487-489,507-521,526-527
 Bench..... 481-484
 Boardroom..... 507-508,513-518
 Boat Shaped..... 515-518
 Cantilever..... 475-480,475-478,526
 Classroom..... 330-344,348-351
 Coffee..... 456,460,466,
 519-522
 Conference..... 507-518
 Craft..... 345-346
 Crushbent Frame..... 331-334
 Early Years..... 387-389
 Early Years, Beech..... 378-388
 Express Delivery Classroom..... 336
 Flip Top..... 347,512,550
 Flower Shaped..... 388,389
 Folding, Dining..... 547-550
 Folding, Meeting..... 512
 Heavy Duty Classroom.....341-342
 Height Adjustable.....348,352,388,
 389,487-488
 MDF Edge..... 331-332,
 335-336,345-346,348-349,351
 Meeting..... 507-518
 Poseur.....551-552
 Premium Classroom..... 337-344,
 346-348,351
 Project..... 345-346
 PU Edge..... 333-337,339-348
 Puzzle..... 344
 Shaped..... 344-345
 Teacher's Desk..... 350
 Themed Early Years..... 388-389
 Tilt Top..... 347,512,550
 Tops..... 552
 Training..... 509-512
 Tray..... 335
 Workbenches..... 345-346
 Welded Frame..... 331-336,
 338-340,345-346
 Tambour Cupboards - Steel..... 530,536
 Tambour Cupboards - Wooden..... 500,
 502,505

Task Chairs..... 430,433-439,442
 Teacher's Desks..... 350
 Themed Tables..... 388-389
 Tilt Top Tables.....347,512,550
 Titan Chairs..... 311,312,322,327
 Tray Tables..... 335
 Tray Storage Units..... 355-368,371,
 373-383

Trolleys

Exam Chairs..... 320
 Exam Desks..... 351
 Tub Chairs..... 459-462

U

Ultrabox Plastic Lockers..... 544

W

Welded Frame Tables..... 331-336,
 338-340,345-346

Whiteboards

Boards..... 405-412
 Coloured Edge..... 407,408
 Easels..... 409-412
 Eco Friendly..... 407
 Revolving..... 411
 Tilting..... 411
 Wooden Cupboards..... 360,364,370,
 372,499-505,529
 Wooden Locker Top Desks..... 349

Workstations

Cantilever Leg..... 475-480,526
 IT Mobile..... 352
 Panel End..... 473-474,527
 Technology Workbench..... 345-346



SCHOOL SUPPLIES INDEX

LOOKING FOR FURNITURE?

See our separate index for
Furniture on pages 571-574

8" x 6 1/2" Exercise Books..... 10
9" x 7" Exercise Books..... 9,10,17-18,20,22

A

A3 Copier Paper..... 31-32,34,36
A4 Copier Paper..... 31-32,34-36
A4 Drywipe Boards..... 100-107
A4 Exercise Books..... 6-8,13,15-17,19-22
A4+ Exercise Books..... 5,14,19,21
A5 Copier Paper..... 32
Academic Diaries..... 54
Academic Wall Planners..... 54
Accident Record Book..... 261
Acrylic Jewels..... 224
Address Labels..... 52
Address Record Book..... 58

Adhesives

Adhesive Tapes..... 149-150
Adhesives..... 147-151,226-229
Blu-Tack..... 151,229
Double Sided Tape..... 150
Glue Sticks..... 147-148,227-228
Hook & Loop Fasteners..... 149,227
Invisible Tape..... 149,227
Masking Tape..... 149,226
Packaging Tape..... 149
Pritt Sticks..... 147,227
PVA Glue..... 226
Sellotape..... 150
Spray Mount..... 151,229
Sticky Fixers..... 147,227
Tape Dispensers..... 150
Velcro..... 149,227
White Tack..... 151,226,229
Air Freshener Sprays..... 291
Air Hardening Clay..... 218
Alcohol Free Wipes..... 262
Alcohol Hand Sanitising Gel..... 272
Aluminium Foil..... 299
Annual Planner 234
Answering Machines..... 170
Antibacterial Soap & Dispensers..... 273-275,282
Antibacterial Wipes..... 269
Aprons, Disposable..... 269
Aprons, Nylon..... 205
Archive Storage Boxes..... 131

Art Papers & Card..... 183-193
Art Straws..... 222
Automatic Pencils..... 72
Avery Labels..... 52

B

Back Supports..... 176
Badge Holders..... 61
Ballot Box..... 133
Ballpoint Pens..... 83-86
Bandages..... 258,261,262
Batteries..... 159
Battery Charger..... 159
Beads..... 223
Berol Drywipe Markers & Pens..... 93,244
Berol Felt Tips..... 90,216
Berol Handwriting Pens..... 82
Bespoke Exercise Books..... 23-24
Bic Ballpens..... 83
Bin Liners..... 285
Binding Combs..... 66
Binding Machines..... 166
Binding Slides 66
Bins..... 138,139,140,286
Biro Pens..... 83-86
Black Card 184
Black Lead Pencils..... 71-72,211-212
Black Sacks..... 285
Bleach..... 291,292
Block Printing Inks 201
Block Printing Sheets..... 201
Blu-Tack..... 151,229
Board Backed Envelopes..... 47
Board Cleaning Fluid..... 98-99
Board Erasers 97-98
Book Bags 206
Book Covering Film 12,25
Book Jackets..... 25
Book & Magazine Racks..... 137,139
Bookends..... 141
Books & Pads..... 26-28,55-60
Border Rolls..... 191-195
Bottles, Water..... 43
Box Files..... 115,120
Breakaway Lanyards..... 61
Brother Labelling Tapes 172
Brushes, Art..... 203-204



Bulk Pack Toilet Roll.....	296
Burn Dressings.....	257
Burn Relief Gel	257
Busyfold Display Panels.....	253

C

CAD Rolls.....	34
Calculators.....	111
Calendar Tabs.....	224
Canvas, Stretched.....	205
Carbonless Papers.....	33

Card

Black Card.....	184
Coloured Card Assortments.....	185
Coloured Copier.....	35-36,187-188
Holographic.....	189
Kaskad, Coloured.....	35-36,187-188
Metallic.....	189
White Card.....	34,184
White Copier.....	31-32
Xerox.....	32,34
Card Holders.....	61
Card Index Boxes.....	126
Cartridge Paper.....	183
Casebound Books.....	27,55,56
Cash Boxes.....	160
CD Envelopes.....	47
CD Markers.....	86
CD's	179
Cellophane Sheets.....	196
Centre Feed Rolls	294
Certificate Paper.....	37
Chalk	87,208
Charcoal.....	210
Children's Drywipe Boards.....	100-107
Children's Drywipe Pens	95-96
Children's Scissors.....	152
Chubbi Paint Markers.....	200
Chubbi Stumps.....	209
Chunky Pencils	71,74,211,213
Clamp Binders.....	119
Clay.....	218
Cleaning Cloths.....	283
Cleaning Sprays.....	280-281
Cleansing Wipes.....	259,262,269
Clear Folders.....	116
Cling Film.....	299
Clip Files.....	118,119
Clipboards.....	62
Clocks.....	161
Coffee.....	297
Coffee Stirrers.....	298
Collage Shapes.....	220-223
Colour Laser Paper.....	35-36,187-188

Coloured Card Assortments.....	185
Coloured Copier Paper & Board.....	185
Coloured Sand.....	225
Colouring Pencils.....	73-75,213-214
Comb Binding.....	66,166
Comb Binding Machines.....	166
Combination Boards.....	251
Compasses.....	109
Compliment Slips.....	40
Computer Cleaning Equipment.....	181
Computer Keyboards.....	176
Copier Film.....	66
Conqueror Paper.....	33
Copier Labels.....	50
Copier Paper.....	31-36
Copyholders.....	177
Cork Notice Boards.....	249,251
Correction Fluid.....	79
Correction Rollers.....	79
Corrugated Borders.....	191,192,193,194
Cotton Wool.....	262
CPR Aids.....	260
Craft Materials	217-225
Crayola Crayons.....	209
Crayons.....	208-210
Creamer Pots.....	298
Creative Paper.....	189
Crepe Paper.....	186

LOOKING FOR FURNITURE?

See our separate index for
Furniture on pages 571-574

Crystalfile Suspension Files.....	124
Cups.....	298
Curling Ribbon.....	220
Cut Flush Folders.....	116

D

Data Storage.....	179
Date Stamps.....	65
Day Planner	53,234
Dazzle Dots.....	220
Desk Accessories.....	137-142
Desk Fans.....	181
Desktop Sorters.....	137,138,139,140,142
Detergent	292
Diaries.....	53
Dictation Machine.....	170
Dinner Money Envelopes.....	48
Dishwasher Tablets.....	289
Disinfectant Fluids.....	280,291,292
Disinfecting Wipes.....	269
Display Accents.....	196
Display Boards.....	241,251
Display Books.....	117-118



Display Paper.....	189-193
Display Panels.....	253
Display Stands.....	253
Disposable Cups.....	298
Disposable Gloves.....	268
Disposable Napkins.....	296
Disposable Plates.....	298
Dividers.....	125-126,
Dividers, Extra Wide.....	125
Document Scanner.....	176
Document Wallets, Manilla.....	122
Document Wallets, Polyprop.....	120
Dolly Pegs.....	217
Door Stops & Wedges.....	160
Double Sided Tape.....	150
Drawing Pins.....	143
Dressings.....	257,258,261,262
Drinking Cups.....	298
Drying Racks.....	206

Drywipe

A4 Boards.....	100-107
Accessories.....	243
Childrens' Boards.....	100-108,235-242
Childrens' Pens.....	95-96
Boards.....	101-108,235-238,241
Erasers.....	97
Easels.....	239-240,242
Magnetic Letters.....	107
Markers.....	88,92-96,243-244
Mini Drywipe Boards.....	100-107
Pens.....	95-96
Whiteboard Cleaning Fluid.....	98,99
Whiteboard Erasers.....	97
Duplicate Books.....	57,58
Dusting Cloth.....	283,284
DVD's.....	179
DYMO Labelling Tapes.....	171
Dyslexia/SEN Exercise Books.....	13,28

E

E-Clips 2 Piece Filing Clips.....	145
EcoColour Noticeboards.....	247-248
Edding Board Markers.....	90,92,216
Elasticated Box Files.....	120
Endorsing Ink.....	64
Envelopes.....	47-48
Eraser Tipped pencils.....	72,212
Erasers, Pencil.....	78
Essentials Tubs.....	143-144

Exercise Books

8 x 6½" Exercise Books.....	10
9 x 7" Exercise Books.....	9,10,17-18,20,22
A4 Exercise Books.....	6-8,13,15-17,19-22
A4+ Exercise Books.....	5,14,19,21
Art & Sketch Books.....	26,59,207

Dyslexia/SEN.....	13
Handwriting Books.....	11
Learn To Write.....	11
Mark Books.....	12
Notebooks.....	11
Overprinted.....	14-18,21-22
Oxford.....	19-22
Personalised Exercise Books.....	23-24
Project Books.....	27
Reading Record Books.....	12
SEN/Dyslexia.....	13
Vocabulary Books.....	11
Wipeable, Rhino.....	6
Exercise Paper.....	29
Expanding Files.....	123
Extension Leads.....	181
Eyewash Fluid.....	257

F

Facial Tissues.....	296
---------------------	-----

LOOKING FOR FURNITURE?

See our separate index for
Furniture on pages 571-574

Fadeless Paper Rolls.....	189,191-192
Fairy Liquid.....	290
Fans.....	181
Fax Machines.....	175
Feathers.....	221
Felt Sheets.....	222
Felt Tip Pens.....	89-90,215-216
Feltboards.....	245-248,250,251,252
Ferby Pencils.....	71,74,211,213
File Spine Labels.....	115
File Storage Boxes.....	128-132

Files

Box Files.....	115,120
Clampbinders.....	119
Clip Files.....	118,119
Crystalfile Suspension Files.....	124
Display Books.....	117,118
Elasticated Files.....	120
Elba Filing Range.....	113,114
Expanding Files.....	123
File Spine Labels.....	115
Flexible Display Books.....	118
Lever Arch Files.....	114
Presentation Ring Binders.....	117
Register Files.....	119
Report Files.....	120
Ring Binders.....	113
Suspension File Tabs.....	124
Suspension Files.....	124
Transfer Files.....	121,131
Filing Clips.....	145



Fineliner Pens.....	88
Finger Bowls.....	202
Finger Cones.....	144
First Aid Cabinet.....	256
First Aid Kit Refills.....	255-256
First Aid Kits.....	255-256,257
Flash Drives.....	179
Flexible Display Books.....	118
Flipchart Easels.....	231-232
Flipchart Markers.....	88

Flipchart Pads.....233

Lined.....	233
Literacy.....	233
Numeracy.....	233
Fluorescent Paints.....	199
Fluorescent Paper & Board.....	35-36,187-188
Foam Dabbers.....	203
Foam Number Shapes.....	203
Foam Shapes Sets.....	217
Foil Rolls.....	189
Foil Shreds.....	224
Foil, Aluminium.....	299
Foldback Clips.....	143,145

Folders

Clear.....	116
Conference.....	62
Cut Flush.....	116
Document Wallets, Manilla.....	122
Document Wallets, Polyprop.....	120
Square Cut.....	121
Footrests.....	177
Forehead Thermometer.....	261,267
Fountain Pens.....	87

G

Gel Pens.....	85-86
General Purpose Cleaning Spray.....	280-281
Geometry Equipment.....	109
Georama Metallic Paper.....	37
Glass Painting Sheets.....	203
Glass Paints.....	200
Glitter Shakers.....	224
Gloss Laminating Pouches.....	46,165
Glue.....	147,148,226,227,228
Glue Spreaders.....	226
Glue Sticks.....	147,148,227,228
Gold Stars.....	51
Golden Star Paper.....	31
Granulated Sugar.....	297
Graph Paper.....	29
Graphite Pencils.....	71-72,211-212
Gratnells Power Trays.....	178
Gratnells Trays.....	136
Guillotines.....	169

H

Half Pencils.....	72,212
Hand Gel.....	272
Hand Soap & Dispensers.....	273-276,282
Hand Towels.....	293
Handwriting Books.....	11,18
Handwriting Pens.....	80-82
Hardback Books.....	27,55,56
HB Pencils.....	71-72,211-212
Heaters.....	181
Highlighters.....	91-92
Holdalls.....	206
Hole Punches.....	157-158
Hole Reinforcements.....	116
Holographic Card.....	189
Hook & Loop Fasteners.....	147,227
Hot & Cold Packs.....	259
Hot Chocolate.....	297

Hygiene Papers

Centre Feed Rolls.....	294
Facial Tissues.....	296
Hand Towels.....	293-294
Toilet Rolls.....	295-296

I

Ice Packs.....	259
----------------	-----

LOOKING FOR FURNITURE?

See our separate index for
Furniture on pages 571-574

ID Badge Laminating Pouches.....	45,165
ID Badges.....	61
ID Card Holders.....	61
ID Lanyards.....	61
Index Tabs.....	70
Indexes.....	125
Indicator Pins.....	143
Ink Pads.....	64
Ink Pens & Refill Cartridges.....	87
Inking Tray.....	201
Inkjet Paper.....	34
Inkjet Paper Rolls.....	34
Inkjet Printers.....	175
Instant Coffee.....	297
Insulated Cups.....	298
Invisible Tape.....	149

J

Jockey Pencils.....	74,213
Jumbo HB Pencils.....	71,74,211,213
Jumbo Toilet Rolls.....	295

K



Kaskad Paper & Card.....	35-36,187-188
Kettle.....	299
Key Safes.....	160
Key Tags.....	144
Keyboards.....	176
Kick Stools.....	301
Kitchen Roll.....	296

L

Labelling Machines.....	172
-------------------------	-----

Labels

Address.....	52
Avery.....	52
Brother Label Printer.....	172
Brother Tapes.....	172
Coloured.....	51
Copier.....	50
Dymo Label Tapes.....	171
Laser.....	50,52
Metallic Stars.....	51
Motivation & Reward.....	51
Photocopier.....	50,52
Spine.....	115

Laminating

Gloss Laminating Pouches.....	46,165
ID Badge Pouches.....	45,165
Machines.....	163-164
Matt Pouches.....	45,165
Pouch Carriers.....	46,164
Roll Film.....	45

Lanyards.....	61
---------------	----

LOOKING FOR FURNITURE?

See our separate index for
Furniture on pages 571-574

Laptop Risers.....	177
Laser Labels.....	50,52
Latex Gloves.....	268
Laundry Markers.....	86
Leaflet Dispensers.....	133-134
Letter Clips.....	143,144,145
Letter Opener.....	49
Letter Trays.....	137,138,139,140
Letterheads.....	40
Lever Arch Files.....	114
Library Boxes.....	128
Lined Flipchart Pads.....	233
Lino Cutters.....	201
Liquid Soap.....	273,282
Literacy Flipchart Pads.....	233
Literature Holders.....	129,130,133,134
Lollipop Sticks.....	217
Lumbar Supports.....	176
Lyra Pencils.....	71,74,213

M

Magazine Files.....	131,138,139,140
Magnetic Letters.....	107
Magnetic Tape.....	243
Magnetic Whiteboard Pins.....	243
Mansize Tissues.....	296
Marbling Ink.....	200
Mark Books.....	12
Marker Pens.....	85,86,88,93,94
Marking Pens.....	88
Masking Tape.....	149,226
Masks, Paper.....	225
Matchsticks.....	217
Maths Instruments.....	109-111
Maths Paper.....	29
Maths Sets.....	109
Matt Laminating Pouches.....	45,165
Medical Gloves.....	268
Memo Boxes.....	139
Memo Pads.....	57
Memory Sticks.....	179
Metallic Paper & Card.....	37
Metallic Stars.....	51
Microfibre Cloth.....	283
Microporous Tape.....	262
Milk.....	298
Mini Drywipe Boards.....	100-108
Mini Jumbo Toilet Rolls.....	295
Modelling Materials.....	218-219
Modelling Rock.....	219
Modelling Tools.....	219
Modelling Wire.....	219
Monitor Risers.....	177
Month Planner.....	234
Motivational Stamps.....	51
Motivational Reward Stickers.....	51
Mounting Paper.....	183
Mounting Spray Adhesive.....	151,226,229
Mouse Mats.....	180
Multifunctional Devices.....	175
MyCopy.....	31,32,34

N

Napkins.....	296
NCR Paper.....	33
Neoprene Sheets.....	219
Nescafe Coffee.....	297
Noris Pencils.....	71,72,75,211,212,214
Notebooks.....	11,27-28,55-57

Noticeboards

Combination.....	251
Cork.....	249,251
EcoColour.....	247-248
Exterior.....	252



Interior.....	245-251
Fire Resistant.....	247,248,250
Lockable.....	245,246,248,252
Number Shapes.....	203
Numeracy Flipchart Pads.....	233

O

Office Bins.....	138,139,140
Office Scissors.....	152
OHP Marker Pens.....	87
OHP Transparencies.....	66
Oil Pastels.....	210
Oxford Campus Notebooks.....	28,56
Oxford Campus Project Books.....	28,56

P

Pads, Refill.....	56,57
Page Markers.....	70

Paint

Drying Racks.....	206
Fluorescent.....	199
Glass Painting Sheets.....	203
Glass Paints.....	200
Paint Palettes.....	202
Paint Pots.....	202
Painting Brushes.....	203,204
Painting Kit for Juniors.....	203
Palettes.....	202
Pearlescent Paints.....	199
Ready Mixed Paint.....	197-199
Scrapers.....	203
Skin Tone Paint.....	199
Watercolour Paints.....	200
Paint Palettes.....	202
Paint Pots.....	202
Painting Brushes.....	203,204
Painting Kit for Juniors.....	203

Paper

Art Papers.....	183-189
CAD Rolls.....	34
Carbonless.....	33
Cartridge.....	183
Certificate.....	37
Colour Laser Paper.....	35-36
Coloured Copier Card.....	35-36,187-188
Coloured Copier Paper.....	35-36,187-188
Conqueror.....	33
Copier Paper.....	31-32,34,35-36,187-188
Creative Paper.....	189
Crepe Paper.....	186
Display Papers.....	190,191,192,193,194
Exercise Paper.....	29
Fadeless Paper Rolls.....	191
Fluorescent Paper & Card.....	35-36,187-188

Foil Rolls.....	189
Graph Paper.....	29
Hygiene Paper.....	293-296
Inkjet Paper.....	34
Kaskad.....	35-36,187-188
Maths Paper.....	29
Metallic Paper & Board.....	37
Mounting Paper.....	183
NCR Paper.....	33
Photo Quality Paper.....	34
Photocopier Paper.....	31-32,34,35-36,187-188
Play.....	183
Poster Rolls & Sheets.....	190
Squared Paper.....	29
Sugar Paper.....	183,193
Tissue Paper.....	186
Toilet Paper.....	295,296
Paper Towels.....	293-294
Tracing Paper.....	196
White Copier Card.....	34
White Copier Paper.....	31-32,34
Wide Format Paper Rolls.....	34
Xerox Paper & Card.....	34
Paper Clips.....	143
Paper Dolls.....	222
Paper Faces.....	222
Paper Fasteners.....	144,146
Paper Masks.....	225
Paper Plates.....	298
Paper Towels.....	293-294
Papier Maché.....	219
Pastels.....	210
Pearlescent Paints.....	199
Pedal Bin Liners.....	285
Pen Pots.....	137,138,139,140

LOOKING FOR FURNITURE?

See our separate index for
Furniture on pages 571-574

Pencil Cases.....	109
Pencil Sharpeners.....	76-77,144

Pencils

Automatic.....	72
Black Lead.....	71-72,211-212
Chunky.....	71,74,211,213
Colouring.....	73-75,213-214
Compass.....	72,212
Eraser Tipped.....	72,212
Erasers, Pencil.....	78
Ferby.....	71,74,211,213
Graphite.....	71-72,211-212
Half Pencils.....	72,212
HB Pencils.....	71-72,211-212
Jockey Pencils.....	74,213
Jumbo HB Pencils.....	71,74,211,213



Lyra Pencils.....	71,74,213
Noris Pencils.....	71,72,75,211,212,214
Stabilo Pencils.....	71,74,211,214
Staedtler Pencils.....	71,72,75,211,212,214
Triangular Grip HB Pencils.....	71,74,211,213

Pens

Ballpoint.....	83-84
Berol Drywipe Markers.....	93,95,244
Berol Felt Tips.....	90,216
Berol Handwriting.....	82
Bic Ballpens.....	83
Bic Drywipe.....	94,244
CD Markers.....	86
Children's Drywipe Pens.....	95-96
Drywipe Markers.....	88,93-94,243,244
EziGlide Drywipe.....	95,244
EziGlide Handwriting.....	82
Felt Tip Pens.....	89-90,215-216
Flipchart Markers.....	88
Fountain Pens.....	87
Gel Pens.....	85-86
Handwriting Pens.....	80-82
Highlighters.....	91-92
Ink Pens & Refill Cartridges.....	87
Laundry Markers.....	86
Marker Pens.....	86,87,88,92,93,94
OHP Marker Pens.....	87
Pen Pots.....	137,138,139,140
Permanent Markers.....	87
Pilot Frixion.....	86
Reception Pen.....	87
Rollerball Pens.....	85-86
Slim Barrel Drywipe.....	95,96
Stabilo Boss Highlighters.....	91
Stabilo Felt Tips.....	90,216
Whiteboard Markers.....	88,93-94,243,244
Perforators.....	157-158
Permanent Marker Pens.....	87
Personal Protection Pack.....	260
Personalised Exercise Books.....	23-24
Personalised Stamps.....	63-64
PG Tips.....	297
Photo Frames.....	251
Photo Quality Paper.....	34
Photocopier Labels.....	50,52
Photocopier Paper.....	31-32,34,35-36,187-188
Pilot Frixion Pens.....	86
Pinboards.....	245-251
Pipecleaners.....	221
Planners – Teacher's.....	53
Planners – Wall.....	234
Plaster, Modelling.....	219
Plasters.....	258
Plates.....	298
Platform Trucks.....	300
Poly Pockets.....	116

Polymer Blocks.....	201
Polyprop 2" Tape.....	149
Pompoms.....	220
Post-it Notes.....	68,69
Postal Scales.....	49
Poster Frames.....	251
Poster Paper Rolls & Sheets.....	183,190
Power Trays, Gratnells.....	178
Power Trolley, Gratnells.....	178
Premium Casebound Notebooks.....	27,56
Protractors.....	109
Presentation Ring Binders.....	117
Printers.....	175
Pritt Sticks.....	147,227
Project Books.....	27,28,56
Projector Film.....	66
Promotional Gifts.....	41
Prospectus Folders.....	40
Punched Pockets.....	116
Punches.....	157-158
Push Pins.....	143
PVA Glue.....	226

Q

Quicksticks.....	148,228
------------------	---------

R

Radio, Two Way.....	170
Raffle Tickets.....	49
Reading Record Books.....	12,53
Ready Mixed Paints.....	197-199
Really Useful Boxes.....	135
Receipt Books.....	57
Reception Pen.....	87
Record Cards.....	70,126
Refill Pads.....	56,57

LOOKING FOR FURNITURE?

See our separate index for
Furniture on pages 571-574

Refuse Sacks.....	285
Register Files.....	119
Report Files.....	120
Repositionable Notes.....	67-70,137
Reward Stickers.....	51
Ribbons.....	220
Ring Binders.....	113,117
Ring Reinforcements.....	116
Risers, Letter Trays.....	137,139,140
Rock Salt, De-icing.....	302
Rollerball Pens.....	85-86
Rolling Pins.....	219
Rotary Trimmers.....	167-169
Rubber Bands.....	144,146
Rubber Gloves.....	268
Rubber Stamps.....	63-65



Ruler Scissors.....	152
Rulers.....	110

S

Sacks, Refuse.....	285
Safeprint Foam Sheets.....	201
Safety Pins.....	144,258
Salt, De-icing.....	302
Sand Shakers.....	225
Sanitiser Gel	272
Sanitising Wipes.....	269
Scalloped Border Rolls.....	191,192,193,194,195
Scanning Devices.....	176
School Easels.....	239-240
Scientific Calculators.....	111
Scissors.....	152
Scouring Sponges.....	290
Scrapbooks.....	27
Scrapers, Paint.....	203
Self-Adhesive Tape.....	149,150
Self-Inking Stamps.....	63,65
Sellotape.....	150
SEN/Dyslexia Exercise Books.....	13
Sequins.....	223
Sharpeners, Pencil.....	76,77,144
Shatter Resistant Rulers.....	110
Shimmer Shower.....	223
Shorthand Pads.....	57
Shredders.....	173-174
Shreds, Foil.....	224
Sick Bags.....	260
Silver Stars.....	51
Sketch Books.....	26,59,207
Skin Tone Paints.....	199
Skin Tone Crayons.....	210
Slide Binders.....	66
Slim Barrel Drywipe Pens.....	95,96
Snap Display Frames.....	251
Snow, Instant.....	225
Soap	273,282
Soft Dough.....	218
Spangles.....	223
Split Pins.....	144,146
Spray Mount Adhesive.....	151,226,229
Square Cut Folders.....	121
Squared Paper.....	29
Stabilo Boss Highlighters.....	91
Stabilo Felt Tips.....	90,216
Stabilo Pencils.....	71,74,211,214
Staedtler Pencils.....	71,72,75,211,212,214
Stamp Ink Pads & Refills.....	64
Stamps.....	63-65
Stamps, Motivational.....	65
Staple Cartridges, Rapesco.....	155
Staple Guns.....	156

Staple Removers.....	155
Staplers.....	153-154
Staples.....	155
Step Ladders.....	301
Sterile Dressings.....	257,261,262
Stickers, Motivational.....	51
Sticky Fixers.....	147,227
Sticky Notes.....	67-69
Stirrers	298
Stop Watches.....	161
Storage Boxes.....	131,135
Storage Trays.....	135,136

Storage Units..... 127-132

Book Storage.....	127-128
Gratnell's Trays.....	136
Stretched Canvas.....	205
String & Twine.....	49
Subject Dividers.....	125,126
Sugar.....	297
Sugar Paper.....	183,193
Surface Wipes.....	259,269
Suspension File Inserts.....	124
Suspension File Tabs.....	124
Suspension Files.....	124
Swash Pencils.....	71,211
Swing Bin Liners.....	285

T

LOOKING FOR FURNITURE?

See our separate index for
Furniture on pages 571-574

Tackers.....	156
Tape Dispensers.....	150
Tape, Self-Adhesive.....	149-150
Tea Bags.....	297
Tea Towels.....	299
Tea Urns.....	299
Teacher's Planners.....	53
Teflon Pouch Carriers.....	46,164
Telephones.....	170
Telephone Message Books.....	58
Tetley Tea.....	297
Thermal Binding Covers.....	66
Thermometer.....	261,267
Thimblettes.....	144
Tipp-Ex.....	79
Tissue Paper.....	186
Tissues.....	296
Toaster.....	299
Toilet Brush Set.....	291
Toilet Cleaning Fluids.....	291-292
Toilet Rolls.....	295,296
Towels, Paper.....	293,294
Towels, Tea.....	299



Tracing Paper.....	196
Transfer Files.....	131
Trays, Storage.....	135,136
Treasury Tags.....	145
Triangular Grip HB Pencils.....	71,74,211,213
Trimmers.....	167-169
Triplicate Books.....	58
Trolleys.....	178,300
Twine.....	49

U

LOOKING FOR FURNITURE?

See our separate index for
Furniture on pages 571-574

Urns.....	299
USB Flash	179

V

Velcro.....	149
Vending Cups.....	298
Vinyl Gloves.....	268
Visitor Badges.....	61
Visitor Books.....	58
Vocabulary Books.....	11
Voice Recorders.....	170
Vomit Bags.....	260

W

Wall Clocks.....	161
Wall Planners.....	234
Wall Pockets.....	129

Wallets

Document, Manilla.....	122
Document, Polyprop.....	120
Zip Wallets.....	112
Washing-up Cloths.....	283
Washing-up Liquid.....	290
Washing-up Pads.....	290
Waste Bins.....	138,139,140,286
Water Bottles.....	43
Watercolour Paints.....	200
Wax Crayons.....	209
Week Planner.....	234
White Art Card.....	184
White Copier Card.....	34
White Copier Paper.....	31-32,34
White Tack.....	151,229
Whiteboard Cleaning Fluid.....	98,99
Whiteboard Erasers.....	97,98
Whiteboard Markers.....	88,93-94,243,244
Whiteboards.....	235-242
Whiteboards, Portable.....	100-108

Whiteboards, Revolving.....	241
Whiteboards, Tabletop.....	100-108
Wide Format Paper Rolls.....	34
Wiggle Eyes	223
Wrist Rests.....	180

X

X-Bands.....	146
Xerox Paper & Card.....	34

Z

Zip Wallets.....	112
Z Notes.....	67



Important Ordering Information...

To ensure your furniture ordering experience is as seamless as possible, please carefully read through the following important checklist...

01 Order early

Place your order as early as you can to avoid extended lead times during the summer months.

02 Check your order

Ensure you are ordering the correct dimensions and colours. Products are made to order so any returns or amendments after an order is confirmed may incur an extra charge. Sizes should also be checked to ensure that the correct size is ordered to suit the correct age group.

03 Contact details

Please supply contact name(s) and mobile phone numbers on all orders. This helps us book deliveries or to call the correct contact during school holidays.

04 Opening times

Please advise opening times if you are expecting a delivery within school holidays. These details will be used to install or deliver the goods on a convenient date.

05 Prepare for the delivery

Remember to keep hold of your old furniture until your new goods arrive, just in case any delays or issues occur. Ensure that there are staff available to receive the delivery as some courier policies are to deliver to the nearest undercover area so some items may need to be moved to the relevant part of the school.

06 Delivery

Some deliveries will be made by pallet via third party couriers within the pallet network and are curbside delivered. Please inform us before placing your order if this is an issue and we will discuss alternative transport options and any relevant costs. Please note, it is the customer's responsibility to remove or dispose of any packaging, including the wooden pallet itself.

07 Returns

Please note furniture is made to order and is therefore generally non-returnable if it has been supplied as per your order. Some suppliers may agree to collect and exchange an item but will usually charge a restocking fee. If it is necessary to return any furniture items then please contact our customer services team on 01527 878348 or email sales@forwardproducts.co.uk.

Notes to remember when ordering

- All classroom and office furniture is made to order so it is important to ensure that the correct size and type of furniture is ordered.
- Delivery times fluctuate throughout the year with lead times being extended during peak months (June-September).





John Knight Interiors is the fitted furniture and projects division of Forward Products, specialising in furniture solutions for Schools, Colleges and Universities.

Our strapline "Designs that work in practice" encapsulates our mission – we provide well designed fitted furniture packages that work for students and educators alike.

We aim to support you at step of the process during the project, with open and honest communication right from the planning stage through to project management and completion.

Our services include:

- Initial site survey by experienced consultant
- Free CAD space planning by design experts
- Full installation service
- Project management



Areas we specialise in:

- Science laboratories
- Food Technology rooms
- Reception desks
- Teaching walls
- IT Suites
- Most other areas - please contact us for more details on enquiry@johnknightinteriors.com or call us on 01527 834798





Tel: 01527 878348

Email: sales@forwardproducts.co.uk

Web: forwardproducts.co.uk

Post: Redcliffe House, Sherwood Rd,
Bromsgrove, B60 3DR



Follow us @[ForwardProducts](https://www.instagram.com/ForwardProducts)