

2021-2022

School & Office Furniture





Forward Furniture are experienced in the supply and installation of furniture for schools, universities and offices. From classrooms and breakout areas through to boardrooms and executive suites, our expertise in interior solutions ensures you get the furniture you want, in the way you want, at the price you need!

1. Assisting you with choosing the right furniture; our inhouse experts are on hand to discuss your requirements to ensure that the correct furniture is specified
2. Site visits or video calls to go through your needs in more detail if relevant
3. CAD space planning assistance so you can visualise your space
4. Providing samples of fabrics, wood finishes and even pieces of furniture where necessary
5. Installation and project management; depending on the size and complexity of your requirements, we take the hassle out of project delivery and keep you updated at every step of the process



If you have a larger project entailing fitted furniture, our projects division John Knight Interiors are here to help.

Please see pages 272-273 for further John Knight Interiors details



Contents



Classroom Chairs

5-26



Classroom Tables

27-50



Classroom Storage

51-81



Early Years Furniture

82-91



Healthcare

92-99



Office Accessories

100-121



Office Seating

122-147



Soft Seating

148-167



Office Furniture

168-219



Express Office Furniture

220-227



Steel Storage

228-241



Dining Furniture

242-255



Fabrics

256-267



Index

268-271



Recent Case Studies



Cloakroom Furniture



Dining Hall Tables & Chairs



Study Area Furniture



Office Furniture & Storage



Breakout Furniture



Classroom Furniture

Important Ordering Information...

To ensure your furniture ordering experience is as seamless as possible, please carefully read through the following important checklist...

01 Order early

Place your order as early as you can to avoid extended lead times during the summer months.

02 Check your order

Ensure you are ordering the correct dimensions and colours. Products are made to order so any returns or amendments after an order is confirmed may incur an extra charge. Sizes should also be checked to ensure that the correct size is ordered to suit the correct age group.

03 Contact details

Please supply contact name(s) and mobile phone numbers on all orders. This helps us book deliveries or to call the correct contact during school holidays.

04 Opening times

Please advise opening times if you are expecting a delivery within school holidays. These details will be used to install or deliver the goods on a convenient date.

05 Prepare for the delivery

Remember to keep hold of your old furniture until your new goods arrive, just in case any delays or issues occur. Ensure that there are staff available to receive the delivery as some courier policies are to deliver to the nearest undercover area so some items may need to be moved to the relevant part of the school.

06 Delivery

Some deliveries will be made by pallet via third party couriers within the pallet network and are curbside delivered. Please inform us before placing your order if this is an issue and we will discuss alternative transport options and any relevant costs. Please note, it is the customer's responsibility to remove or dispose of any packaging, including the wooden pallet itself.

07 Returns

Please note furniture is made to order and is therefore generally non-returnable if it has been supplied as per your order. Some suppliers may agree to collect and exchange an item but will usually charge a restocking fee. If it is necessary to return any furniture items then please contact our customer services team on 01527 878348 or email sales@forwardproducts.co.uk.

Notes to remember when ordering

- All classroom and office furniture is made to order so it is important to ensure that the correct size and type of furniture is ordered.
- Delivery times fluctuate throughout the year with lead times being extended during peak months (June-September).



Educational Furniture Height Guide

To help you purchase educational furniture in the correct heights for children, the following guide outlines recommend table and chair heights that comply with the British and European Standards (1729). As pupil heights can vary from cohort to cohort we recommend you measure their stature and popliteal heights (see below for an explanation on these terms) and then match these up to the below guide. If your priority is to match the heights of existing furniture, you will need to check these and specify them when ordering.

Standing & Working Heights

To help you purchase furniture that complies with the British and European Standards (1729), the following height guide indicates which fixed seat heights and table heights are suitable for the correct age and size. To ensure you purchase the most accurate height furniture correct in compliance with the standards, we recommend that you measure the stature and popliteal height. You can then match those measurements using the guide below.

For a visual guide to the different chair and table heights, please refer to the table below.

| | SIZE MARK | AGE RANGE | POPLITEAL HEIGHT RANGE | STATURE RANGE | TABLE HEIGHT | CHAIR HEIGHT |
|---|-----------------|-------------|------------------------|---------------|--------------|--------------|
| 1 | NURSERY | 3-4 years | 250 - 280mm | 930 - 1150mm | 460mm | 260mm |
| 2 | PRIMARY | 4-6 years | 280 - 315mm | 1080 - 1210mm | 530mm | 310mm |
| 3 | PRIMARY | 6-8 years | 315 - 355mm | 1190 - 1420mm | 590mm | 350mm |
| 4 | PRIMARY | 8-11 years | 355 - 405mm | 1330 - 1590mm | 640mm | 380mm |
| 5 | SECONDARY | 11-14 years | 405 - 435mm | 1460 - 1765mm | 710mm | 430mm |
| 6 | SECONDARY/ADULT | 14 + | 435 - 485mm | 1590 - 1880mm | 760mm | 460mm |

Standing & Working Heights

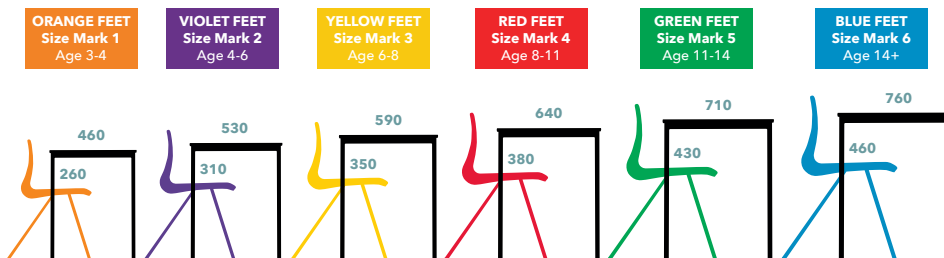

Popliteal Height

Popliteal height defines the correct seat height. The measurement is taken from the floor to the back of the knee when seated, with thighs horizontal and lower leg vertical with feet flat to the floor.

Stature

Stature is from floor to the top of the head.

Sitting Work Height

Sitting work height defines the correct table height. The measurement is determined by sitting elbow height, which is the distance from the floor to the underside of the elbow whilst sitting with the upper arm vertical and the lower arm horizontal.

Standing Work Height

Standing work height defines the correct standing table height. The measurement is determined by standing elbow height, which is the distance from the floor to the underside of the elbow of a standing person with the upper arm vertical and lower arm horizontal.

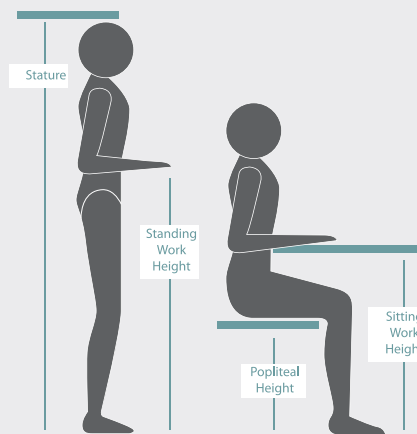

1

Classroom Chairs

| | |
|-------------------|-------|
| Classroom Seating | 6-16 |
| Folding Chairs | 17 |
| IT Seating | 18-19 |
| Stools | 20-24 |
| High Chairs | 24-25 |



Dumbell Wobble Stool

An active sit for engaged learning, Dumbell stools support student movement, which is essential for cognitive development. Featuring a rounded base for an active sit, the stools offer freedom to fidget, which can help keep bodies and minds engaged. With its small scale and light weight, it is easy for students and teachers alike to carry and reposition as needed. When flipped, the gently concaved top with waterfall edge nests with the convex base to stack up to 3-high. The colour options offer playful appeal, while all-poly construction and a nonslip base design ensure durability and stability for years to come.

- All seating surface pad, base and spacer rings are in Iron Grey/Blue Grey (as shown). The underside is a textured, non-slip thermoplastic rubber padding in black
- Stacks up to 3 high (upside down)
- Available in 5 standard colours & 4 heights from 300-450mm
- Convex base offers 12° of rebounding motion
- Base weighted with steel for added stability
- Waterfall seat edge
- Thermoplastic rubber base is non-slip and suitable for carpet and hard floors
- Slightly concave seat pad with textured surface for added comfort
- Compact, lightweight & easy to move with integrated handle under seat lip

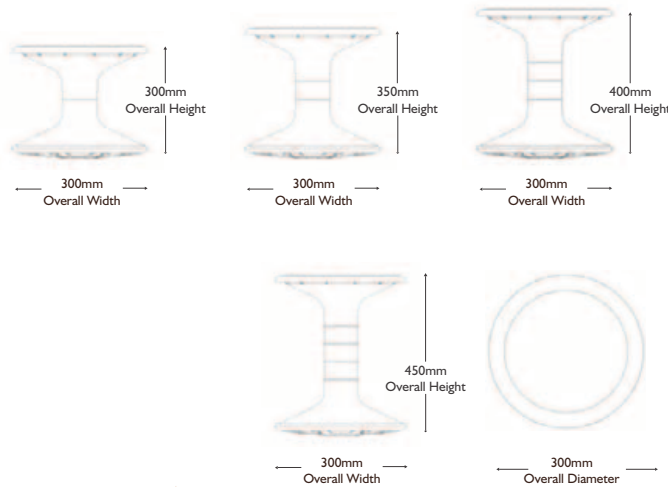

| | Height | 1-5 | 6-29 | 30+ |
|---------|--------|--------|--------|--------|
| C212631 | 300mm | £55.36 | £52.05 | £48.73 |
| C212632 | 350mm | £57.87 | £54.40 | £50.94 |
| C212633 | 400mm | £60.54 | £56.91 | £53.29 |
| C212634 | 450mm | £64.13 | £60.29 | £56.45 |

* Please specify colour when ordering



Polypropylene Colours



Ash Grey Aqua Blue Parrot Green Sugar Plum Tangerine Fizz

Postura Plus Chairs

- Designed to promote posture and exceptional comfort
- Fully certified to EN1729 Parts 1 & 2 for dimensions, strength and stability
- 20 year guarantee
- Stackable up to 12 high (chair only)
- Please check colour availability when ordering as some colours are only available in larger sizes
- **Please see Important Furniture Ordering Information on page 3 before placing your furniture order**



Postura Plus Chair

| | | 1-5 | 6-29 | 30+ |
|---------|--------|--------|--------|--------|
| C212811 | H260mm | £24.32 | £19.35 | £18.57 |
| C212812 | H310mm | £25.49 | £20.28 | £19.47 |
| C212813 | H350mm | £26.04 | £20.71 | £19.88 |
| C212814 | H380mm | £26.99 | £21.47 | £20.61 |
| C212815 | H430mm | £29.57 | £23.52 | £22.58 |
| C212816 | H460mm | £31.20 | £24.82 | £23.83 |



Postura Plus High Chair

- Integral bag hook

| | | 1-5 | 6-29 | 30+ |
|---------|--------|--------|--------|--------|
| C212821 | H560mm | £61.61 | £53.40 | £51.35 |
| C212822 | H610mm | £62.17 | £53.88 | £51.81 |
| C212823 | H685mm | £66.24 | £57.41 | £55.20 |



Postura Plus Stool

- Integral bag hook

| | | 1-5 | 6-29 | 30+ |
|---------|--------|--------|--------|--------|
| C212831 | H560mm | £51.17 | £44.35 | £42.64 |
| C212832 | H610mm | £52.22 | £45.26 | £43.52 |
| C212833 | H685mm | £53.98 | £46.78 | £44.98 |



Postura Plus Task Chair

- Available with castors or glides, please specify when ordering

| | | 1-5 | 6-29 | 30+ |
|---------|-----------------|--------|--------|--------|
| C212841 | Chair w/Castors | £80.90 | £72.95 | £69.95 |
| C212842 | Chair w/Glides | £80.90 | £72.95 | £69.95 |

Seat Colours





5-7 day delivery

20 YEAR GUARANTEE



Linking clip

Stackable 15 high

Titan One Piece Chairs

- This innovative chair is the first one-piece polypropylene chair that has attained EN1729 certification
- The benefit of one-piece polypropylene chairs is well documented in terms of their longevity (20 year guarantee), comfort and safety in the classroom
- With no screws or rivets, no sharp edges and no metal work to rust, the Titan chair offers all the benefits of a one-piece chair with the added EN1729 certification
- Stackable 15 high and offering excellent value for money
- 20 year guarantee
- **Please see Important Furniture Ordering Information on page 3 before placing your furniture order**

Titan Chairs

| | | 1-5 | 6-29 | 30+ |
|---------|--------------------|--------|--------|--------|
| C212691 | H310mm | £21.55 | £17.14 | £16.39 |
| C212692 | H350mm | £22.42 | £17.83 | £17.06 |
| C212693 | H380mm | £22.64 | £18.01 | £17.22 |
| C212694 | H430mm | £25.55 | £20.32 | £19.63 |
| C212695 | H460mm | £25.95 | £20.65 | £19.95 |
| C212696 | Linking Attachment | £3.68 | £2.93 | £2.88 |

Please Specify:

Seat colour

Seat Colours



Sizes 310, 350 and 380 are not available in Burgundy, Grey, Charcoal or Black

5-7 day
delivery

Titan 4 Leg Chair

- Combining the comfort of the plastic seat with strong steel legs and protective feet
- Super strong tubular steel frame
- 10 year guarantee

| Code | Seat Height | Overall Width | 1-5 | 6-29 | 30+ |
|---------|-------------|---------------|--------|--------|--------|
| C212721 | 350 | 440 | £22.76 | £19.15 | £18.23 |
| C212722 | 380 | 440 | £22.95 | £19.30 | £18.37 |
| C212723 | 430 | 500 | £23.46 | £19.74 | £18.79 |
| C212724 | 460 | 500 | £24.06 | £20.24 | £19.26 |

Please see Important Furniture Ordering Information on page 3 before placing your furniture order

Titan Skid Chair

- Skid based chair for ease of movement, stacks up to 5 high
- Ultra strong oval tube steel frame
- 10 year guarantee

| Code | Seat Height | Overall Width | 1-5 | 6-29 | 30+ |
|---------|-------------|---------------|--------|--------|--------|
| C212741 | 350 | 480 | £25.18 | £21.18 | £20.16 |
| C212742 | 380 | 480 | £25.96 | £21.84 | £20.78 |
| C212743 | 430 | 540 | £26.46 | £22.26 | £21.19 |
| C212744 | 460 | 540 | £26.67 | £22.44 | £21.35 |

Please Specify:

Seat colour

Seat Colours



Red Blue Yellow Green Burgundy Grey Charcoal Black Lime Purple Orange Sky Blue

Sizes 350 and 380 are not available in Burgundy, Grey, Charcoal or Black





Sustainable materials - uses less materials than other chairs in its class

EN One Piece Chair

- Lightweight one piece polypropylene chair with unique back handhold
- Streamline modern design with exceptional ergonomics
- Efficient to store, up to 21 chairs stack within a 2 metre height
- 21 year guarantee
- Please specify seat colour required when ordering
- **Please see Important Furniture Ordering Information on page 3 before placing your furniture order**

| | | 1-5 | 6-29 | 30+ |
|---------|--------|--------|--------|--------|
| C212753 | H260mm | £22.30 | £16.36 | £15.49 |
| C212754 | H310mm | £23.15 | £16.99 | £16.08 |
| C212755 | H350mm | £24.22 | £17.77 | £16.83 |
| C212756 | H380mm | £25.51 | £18.72 | £17.72 |
| C212751 | H430mm | £30.23 | £22.18 | £20.99 |
| C212752 | H460mm | £30.86 | £22.64 | £21.44 |



Perfect for high volume applications

Please Specify:

Seat colour

Seat Colours

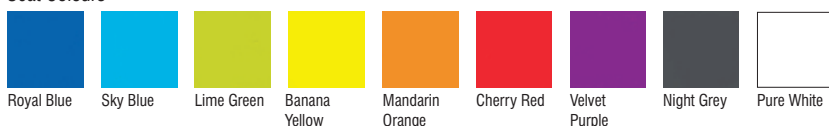

Stacks up to 21 high



EN Series Chair

- Popular and robust polypropylene chair with gas injected ribbing for ultimate shell strength
- Ergonomic shell support for the lower back, flexing naturally with the user's movement
- Angled rear legs to prevent user tilting
- Stacks 6 high
- Exceptional 15 year guarantee
- Stylish silver grey frame as standard. Chrome frame available on some sizes, please call for details



| | | 1-5 | 6-29 | 30+ |
|---------|--------|--------|--------|--------|
| C212761 | H260mm | £41.48 | £31.33 | £29.81 |
| C212762 | H310mm | £41.48 | £31.33 | £29.81 |
| C212763 | H350mm | £43.53 | £32.87 | £31.27 |
| C212764 | H380mm | £43.53 | £32.87 | £31.27 |
| C212765 | H430mm | £46.45 | £35.08 | £33.38 |
| C212766 | H460mm | £46.45 | £35.08 | £33.38 |

EN Series Skid Base Chair

- Stacks 5 high
- 460mm high only

| | | 1-5 | 6-29 | 30+ |
|---------|--------|--------|--------|--------|
| C212771 | H460mm | £56.47 | £42.65 | £40.58 |



EN Series Reverse Cantilever Chair

- H460mm
- Stacks 5 high

| | | 1-5 | 6-29 | 30+ |
|---------|--------|--------|--------|--------|
| C212776 | H460mm | £76.20 | £58.03 | £55.84 |



Please see Important Furniture Ordering Information on page 3 before placing your furniture order

Please call for prices on bulk quantities

Please Specify:

Seat colour

Seat Colours



*Chair heights 260, 310, 350 and 380 only available in these colours



Classic Chair

- Very popular polypropylene chair with distinctive hand hold for easy handling
- Wide range of seat and frame colours
- 5 year guarantee
- Tested to EN1729 for strength and stability
- Please confirm seat colour when ordering
- Stack 15 high
- Black 19mm steel frame

| | | 1-5 | 6-29 | 30+ |
|---------|--------|--------|--------|--------|
| C212571 | H260mm | £25.91 | £18.15 | £17.78 |
| C212572 | H310mm | £25.91 | £18.15 | £17.78 |
| C212573 | H350mm | £25.91 | £18.15 | £17.78 |
| C212574 | H380mm | £26.66 | £18.67 | £18.30 |
| C212575 | H430mm | £26.92 | £18.85 | £18.47 |
| C212576 | H460mm | £27.17 | £19.03 | £18.65 |

Please call for prices on bulk quantities

Please see Important Furniture Ordering Information on page 3 before placing your furniture order

Please Specify:

1. Seat colour

Standard Seat Colours



Royal Blue Cherry Red Bottle Green Yellow Purple Night Grey Chocolate Cool Grey



Storm Chair

- Classic look and feel
- Extremely strong and durable
- Unrivalled posture support across all ages
- Easy stacking up to 7 high
- Tested to EN 1729 Part 2
- 5 year guarantee

| | | 1-5 | 6-29 | 30+ |
|---------|--------|--------|--------|--------|
| C212921 | H260mm | £36.36 | £27.30 | £23.53 |
| C212922 | H310mm | £37.27 | £27.98 | £24.11 |
| C212923 | H350mm | £38.12 | £28.62 | £24.66 |
| C212924 | H380mm | £42.97 | £32.27 | £27.81 |
| C212925 | H430mm | £42.54 | £33.22 | £28.63 |
| C212926 | H460mm | £44.32 | £34.61 | £29.82 |



Storm Skid Base Chair

- Details as above but with a skid base

| | | 1-5 | 6-29 | 30+ |
|---------|--------|--------|--------|--------|
| C212927 | H430mm | £45.16 | £40.95 | £34.95 |
| C212928 | H460mm | £45.73 | £41.15 | £34.95 |



Please see Important Furniture Ordering Information on page 3 before placing your furniture order

Please Specify:

1. Seat colour
2. Frame colour

Seat Colours



Frame Colours

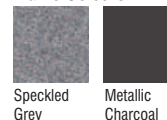

Speckled Grey will be supplied if no colour is specified



Eco Chair

- Popular, high volume stacking chair
- Available in Black and Petrol Blue with a Black frame
- 430mm high
- 12 month guarantee
- Tested to EN 1729 Part 2

| | | 1-5 | 6-29 | 30+ |
|---------|-------------|--------|--------|--------|
| C212891 | Petrol Blue | £19.95 | £13.55 | £12.37 |
| C212892 | Black | £21.95 | £14.30 | £12.99 |



Please see Important Furniture Ordering Information on page 3 before placing your furniture order



Affinity Chair

- Durable polypropylene chair with high quality steel frame
- Excellent stacking properties
- 6 year guarantee
- Tested to EN 1729 Part 2

| | | 1-5 | 6-29 | 30+ |
|---------|--------|--------|--------|--------|
| C212911 | H260mm | £18.85 | £12.27 | £12.43 |
| C212912 | H310mm | £20.55 | £13.38 | £12.74 |
| C212913 | H350mm | £21.25 | £13.87 | £13.16 |
| C212914 | H380mm | £22.50 | £14.68 | £13.99 |
| C212915 | H430mm | £22.98 | £15.52 | £14.66 |
| C212916 | H460mm | £24.27 | £16.39 | £15.50 |



Please Specify:

1. Seat colour
2. Frame colour

Affinity Chair Seat Colours



Frame Colours





Hype Chair

- Robust classroom chair giving great value for money
- Integral lumbar support and comfortable waterfall seat front
- Stackable up to 8 high
- 5 year guarantee
- Please confirm seat and frame colours when ordering



| | | 1-5 | 6-29 | 30+ |
|---------|--------|--------|--------|--------|
| C212641 | H260mm | £22.47 | £16.98 | £14.82 |
| C212642 | H310mm | £23.11 | £17.46 | £15.24 |
| C212643 | H350mm | £28.42 | £21.48 | £18.76 |
| C212644 | H380mm | £29.00 | £21.91 | £19.14 |
| C212645 | H430mm | £31.12 | £23.52 | £20.53 |
| C212646 | H460mm | £32.64 | £24.67 | £21.54 |



Hype Chair Trolley

- Easy to use trolley suitable for use with all Hype chairs
- Also suitable for use with most other 4 leg chairs

| | | |
|---------|---------------|--------|
| C212651 | Chair Trolley | £76.50 |
|---------|---------------|--------|



Please see Important Furniture Ordering Information on page 3 before placing your furniture order

Please Specify:

1. Seat colour
2. Frame colour

Seat Colours



Blue

Charcoal

Green

Lilac

Orange

Purple

Red

Soft Blue

Tangy Lime

Yellow

Frame Colours -

Speckled Grey will be supplied if no colour is specified



Speckled Grey

Metallic Charcoal



CALL US ON 01527 878348



VISIT WWW.FORWARDPRODUCTS.CO.UK



FULLY EN1729 COMPLIANT

15 YEAR GUARANTEE

Upholstered Version Available

Inspire Chair

- Ergonomically designed for correct posture
- Fully compliant to BSEN1729
- Smooth lines give a clean shape which is both comfortable and supportive
- Extra strong under carriage with no separate under-frame
- Outstanding 15 year guarantee
- Can be stacked up to 10 high
- Speckled grey frame colour as standard



Stacking



Linking

| Code | Height | 1-5 | 6-29 | 30+ |
|---------|-------------------------------------|--------|--------|--------|
| C212851 | 260mm | £28.25 | £21.17 | £19.19 |
| C212852 | 310mm | £29.73 | £22.27 | £20.19 |
| C212853 | 350mm | £31.40 | £23.53 | £21.33 |
| C212854 | 380mm | £32.28 | £24.19 | £21.93 |
| C212855 | 430mm | £39.36 | £29.49 | £26.74 |
| C212856 | 460mm | £40.87 | £30.63 | £27.76 |
| C212857 | Linking Device | £6.24 | £5.95 | £5.77 |
| C212858 | Upholstered Factory Fitted Seat Pad | £6.38 | £4.85 | £4.59 |

Please see Important Furniture Ordering Information on page 3 before placing your furniture order

Please Specify:

1. Seat colour
2. Fabric colour

Seat Colours



Fabric Options for Seat Pad

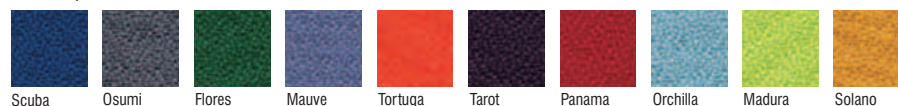

Folding Chairs

- Great range of folding chairs perfect for exams, events, school productions etc.
- Secure wrap-around back fixing to the frame
- Grey steel frame with double riveted cross braces for strength
- Protective feet buffers
- Comfortable fan back or straight back available
- Heavy duty trolley available for ease of transportation and storage
- **Please see Important Furniture Ordering Information on page 3 before placing your furniture order**



Fan Back Chair

- Integral linking feature
- Height 450mm

| | | 1-5 | 6-29 | 30+ |
|---------|----------------|--------|--------|--------|
| C212861 | Blue Chair | £21.31 | £15.63 | £14.79 |
| C212862 | Burgundy Chair | £21.31 | £15.63 | £14.79 |
| C212863 | Grey Chair | £21.31 | £15.63 | £14.79 |



Straight Back Chair

- Height 450mm

| | | 1-5 | 6-29 | 30+ |
|---------|----------------|--------|--------|--------|
| C212871 | Blue Chair | £19.85 | £14.56 | £13.79 |
| C212872 | Burgundy Chair | £19.85 | £14.56 | £13.79 |
| C212873 | Grey Chair | £19.85 | £14.56 | £13.79 |



Trolleys

- Heavy duty steel trolleys
- Two standard and two lockable castors
- Storage ratchet straps recommended for 40 chair flat bed trolley (not supplied)
- 40 chair trolley dimensions: w1100 x d490 x h90mm (not loaded)
- 60 chair trolley dimensions: w1770 x d780 x h1340mm (when loaded)

| | | |
|---------|------------------|---------|
| C212881 | 40 Chair Trolley | £147.10 |
| C212882 | 60 Chair Trolley | £264.88 |



40 Chair Trolley



60 Chair Trolley

Please see Important Furniture Ordering Information on page 3 before placing your furniture order



EN Series Swivel Chair

- Elegant and comfortable IT chair
- Ergonomically shaped shell with gas injected ribbing for ultimate strength
- 15 year guarantee
- Available with castors or glides
- Height 390 - 520mm

| | | 1-5 | 6-29 | 30+ |
|---------|--------------|--------|--------|--------|
| T211121 | With Castors | £83.23 | £74.55 | £72.38 |
| T211122 | With Glides | £83.23 | £74.55 | £72.38 |

Colour Options

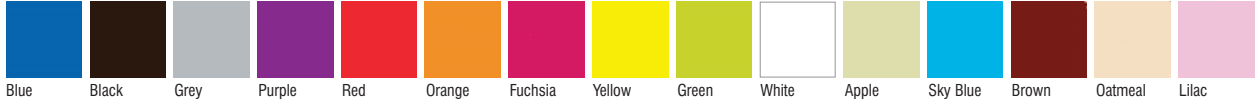

5 YEAR GUARANTEE

Now available in anti-microbial woven fabric, effective against Covid-19 see page 262

Tamperproof IT Chair

- Perfect for IT suites and classrooms
- Fixed back chairs with gas lift height adjustment
- 5 year guarantee
- Price based on Advantage fabric, please see pages 258-265 for further fabric options (prices POA)
- Heights: infant 320-410mm, junior 400-480mm & secondary 440-510mm
- Available with glides or castors

| With Castors | Height mm | 1-5 | 6-29 | 30+ |
|--------------|-----------|--------|--------|--------|
| T211135* | 320 - 410 | £92.78 | £89.78 | £82.61 |
| T211136* | 400 - 480 | £92.78 | £89.78 | £82.61 |
| T211137* | 440 - 510 | £92.78 | £89.78 | £82.61 |

| With Glides | Height mm | 1-5 | 6-29 | 30+ |
|-------------|-----------|--------|--------|--------|
| T211138* | 320 - 410 | £92.78 | £89.78 | £82.61 |
| T211139* | 400 - 480 | £92.78 | £89.78 | £82.61 |
| T211140* | 440 - 510 | £92.78 | £89.78 | £82.61 |

* Please specify fabric colour



Popular Fabric Colour Options
Standard Fabric - Advantage



Premium Fabric – Aquarius (add 35% to prices)

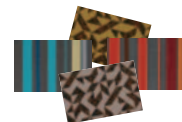

See pages 258-265 for further fabric options



5 YEAR GUARANTEE

Classic IT Chair

- Strong poly shell on a tamper proof gas lift base
- The Classic IT chair is in use in hundreds of schools and is a proven reliable chair
- 5 year guarantee
- Height range 390-520mm
- Available with castors or glides

| | | 1-5 | 6-29 | 30+ |
|---------|--------------|--------|--------|--------|
| T211141 | With Castors | £63.94 | £57.91 | £55.50 |
| T211142 | With Glides | £63.94 | £57.91 | £55.50 |



Colour Options

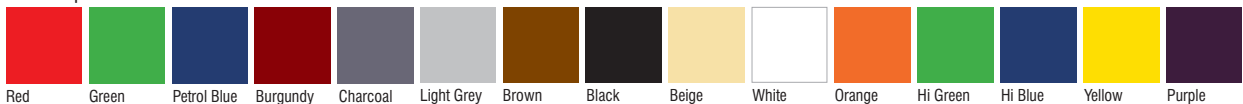

Hype Swivel Chair

- Robust IT chair giving great value for money
- Integral lumbar support and comfortable waterfall seat front
- 5 year guarantee
- Available in two heights with castors or glides

| With Castors | | 1-5 | 6-29 | 30+ |
|--------------|-----------------------------|---------|--------|--------|
| T211151 | H355 - 420mm Black Base | £102.51 | £70.39 | £68.34 |
| T211152 | H420 - 480mm Black Base | £105.06 | £72.14 | £70.04 |
| T211153 | H355 - 420mm Chrome Base | £118.82 | £87.42 | £84.87 |
| T211154 | H420 - 480mm Chrome Base | £122.71 | £90.28 | £87.65 |

| With Glides | | 1-5 | 6-29 | 30+ |
|-------------|-----------------------------|---------|--------|--------|
| T211155 | H355 - 420mm Black Base | £102.51 | £70.39 | £68.34 |
| T211156 | H420 - 480mm Black Base | £105.06 | £72.14 | £70.04 |
| T211157 | H355 - 420mm Chrome Base | £118.82 | £87.42 | £84.87 |
| T211158 | H420 - 480mm Chrome Base | £122.71 | £90.28 | £87.65 |

Colour Options - All Sizes



Please see Important Furniture Ordering Information on page 3 before placing your furniture order

Titan Swivel IT Chair

- Stylish chair with chrome base
- Complies with EN1729 regulations
- Junior sizes: H405 - 460mm
- Adult sizes: H465 - 555mm
- Castors or glides available

| With Castors | | 1-5 | 6-29 | 30+ |
|--------------|--------|--------|--------|--------|
| T211161 | Junior | £59.16 | £51.27 | £49.30 |
| T211162 | Adult | £63.72 | £55.22 | £53.10 |

| With Glides | | 1-5 | 6-29 | 30+ |
|-------------|--------|--------|--------|--------|
| T211163 | Junior | £59.16 | £51.27 | £49.30 |
| T211164 | Adult | £63.72 | £55.22 | £53.10 |



See pages 8 & 9 for matching 4 leg chairs



Colour Options - All Sizes





Steel feet are a valuable addition where harsh or abrasive floor surfaces wear down standard plastic feet.



Ergoform Stools

- The UK's best selling and most popular classroom stool
- These stools are specified for major projects country wide because of their unique seat shape and integral lumbar support
- The stools have a robust frame, unique lumbar support and a well positioned footrest
- The stools come in 10 shell colours with an option for steel feet and have a 5 year guarantee
- **Please see Important Furniture Ordering Information on page 3 before placing your furniture order**

| | | 1-5 | 6-29 | 30+ |
|---------|------------------|--------|--------|--------|
| C212931 | H395mm | £40.81 | £30.84 | £28.98 |
| C212932 | H445mm | £40.81 | £30.84 | £28.98 |
| C212933 | H560mm | £40.81 | £30.84 | £28.98 |
| C212934 | H610mm | £40.81 | £30.84 | £28.98 |
| C212935 | H685mm | £40.81 | £30.84 | £28.98 |
| C212936 | Steel Feet Set 4 | £4.90 | £4.55 | £4.35 |

Ergoform Skid Base Stool

- Reduce wear on floors
- Extremely strong and stable
- Same popular seat design

| | | 1-5 | 6-29 | 30+ |
|---------|--------|--------|--------|--------|
| C212941 | H610mm | £45.71 | £34.54 | £32.46 |
| C212942 | H685mm | £45.71 | £34.54 | £32.46 |

Please Specify:

1. Seat colour
2. Frame colour



Seat Colours



FULLY EN1729 COMPLIANT

Frame Colours

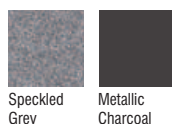

Speckled Grey will be supplied if no colour is specified

Stool with Polished MDF Seat

- Based on the same design as the poly stacking stool, this stool has an MDF seat with a handhold
- Steel feet are essential where highly abrasive flooring is used
- Stackable up to 6 high
- Available with traditional polished MDF seat or hardwearing beech laminated seat
- Please see previous page for frame colour options

| | | 1-5 | 6-29 | 30+ |
|---------|------------------|--------|--------|--------|
| C212961 | H470mm | £36.71 | £27.74 | £26.08 |
| C212962 | H520mm | £36.71 | £27.74 | £26.08 |
| C212963 | H570mm | £36.71 | £27.74 | £26.08 |
| C212964 | H620mm | £36.71 | £27.74 | £26.08 |
| C212965 | H670mm | £36.71 | £27.74 | £26.08 |
| C212936 | Steel Feet Set 4 | £4.90 | £4.55 | £4.35 |



Stool with Beech Laminated Seat

- Please see previous page for frame colour options
- Same specification as above stools except with Beech laminated seat (not pictured)

| | | 1-5 | 6-29 | 30+ |
|---------|------------------|--------|--------|--------|
| C212971 | H470mm | £36.71 | £27.74 | £22.90 |
| C212972 | H520mm | £36.71 | £27.74 | £22.90 |
| C212973 | H570mm | £36.71 | £27.74 | £22.90 |
| C212974 | H620mm | £36.71 | £27.74 | £22.90 |
| C212975 | H670mm | £36.71 | £27.74 | £22.90 |
| C212936 | Steel Feet Set 4 | £4.90 | £4.55 | £4.35 |

Stained MDF tops available in 4 colours. Please call for details

Rectangular Stools

- This highly popular stool has a 22mm sturdy tubular frame with a poly seat
- Please see below for seat colour options
- Only available with black frames



Polyprop Stacking Stool

| | | 1-5 | 6-29 | 30+ |
|---------|--------|--------|--------|--------|
| C212955 | H610mm | £38.63 | £27.59 | £24.85 |
| C212956 | H660mm | £38.63 | £27.59 | £24.85 |



Please Specify:

1. Seat colour

Standard Seat Colours



Slate

Green

Red

Blue

Please see Important Furniture Ordering Information on page 3 before placing your furniture order



Beech Cantilever Stool

- Waterfall seat front
- Scuff resistant & anti-tilt feet buffers
- Complies to EN1729
- 50 x 30mm oval frame
- Stacking 6 high
- Fully welded grey frame
- Height 610mm
- 25 year frame guarantee

| | 1-5 | 6-29 | 30+ |
|---------|--------|--------|--------|
| C212493 | £60.59 | £43.28 | £40.55 |



Aero Stool

- New innovative design
- Aeriated, angled seat
- Heavy duty frame with stable design
- Long lasting Duragrip feet
- Choose from 7 bright, modern seat colours and 3 frame colours
- Complies with EN1729
- 10 year guarantee
- Please specify seat colour and frame colour at time of ordering

| | | 1-5 | 6-29 | 30+ |
|---------|--------|--------|--------|--------|
| C212991 | H430mm | £43.17 | £32.07 | £31.11 |
| C212992 | H525mm | £43.17 | £32.07 | £31.11 |
| C212993 | H610mm | £43.17 | £32.07 | £31.11 |
| C212994 | H685mm | £43.17 | £32.07 | £31.11 |
| C212995 | H760mm | £43.17 | £32.07 | £31.11 |



Please Specify:

1. Seat colour
2. Frame colour

Seat Colours



Frame Colours



Zing Stool

- Sleek new moulded ply cantilever stool
- Perfect for laboratory, craft and food tech environments
- Stackable to 8 high
- Comfortable waterfall front edge and hand hold in back
- Funky coloured seats available
- Please specify seat and frame colours when ordering

| Maple Seat | | 1-5 | 6-29 | 30+ |
|------------|--------|--------|--------|--------|
| C213121 | H640mm | £98.06 | £74.10 | £71.79 |
| C213122 | H670mm | £98.95 | £74.78 | £72.45 |

| Coloured Seat | | 60+ | |
|---------------|--------|-----|--|
| C213123 | H640mm | POA | |
| C213124 | H670mm | POA | |



Please see Important Furniture Ordering Information on page 3 before placing your furniture order

Did you know?
Our John Knight Interiors division specialises in fitted furniture for science labs - call them on **01527 834798** to discuss your requirements



Please Specify:

1. Seat colour
2. Frame colour

Seat Colours



Frame Colours

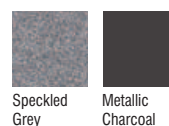

Speckled Grey will be supplied if no colour is specified



Titan Stool

- Ergonomically designed stool with integral lumbar support
- Stylish and durable silver frame
- 10 year guarantee
- Stackable to 10 high
- Available in Charcoal, Black, Blue, Green, Grey and Red

| | | 1-5 | 6-29 | 30+ |
|---------|--------|--------|--------|--------|
| C213131 | H455mm | £46.85 | £35.41 | £33.27 |
| C213132 | H560mm | £46.85 | £35.41 | £33.27 |
| C213133 | H610mm | £47.02 | £35.54 | £33.39 |
| C213134 | H685mm | £47.02 | £35.54 | £33.39 |



Titan High Chair

- Derived from the popular one piece chair, the Titan High Chair has the same strength and comfort but with a stylish and durable high frame
- Skid base perfect for protection of hard floors in science labs and food tech rooms
- Non-stackable
- Available in all 12 colours as shown below

| | | 1-5 | 6-29 | 30+ |
|---------|--------|--------|--------|--------|
| C213141 | H455mm | £53.97 | £40.79 | £38.33 |
| C213142 | H560mm | £55.89 | £42.24 | £39.69 |
| C213143 | H610mm | £58.30 | £44.06 | £41.41 |
| C213144 | H685mm | £60.29 | £45.56 | £42.82 |



Please Specify:

Seat colour

Seat Colours Please note that stools are not available in Burgundy, Yellow, Lime, Orange, Sky and Purple



Hype High Chair

- Robust high chair giving great value for money
- Integral lumbar support and comfortable waterfall seat front
- Available in the 2 most popular heights

| | | 1-5 | 6-29 | 30+ |
|---------|--------|--------|--------|--------|
| C213151 | H610mm | £48.98 | £33.63 | £29.39 |
| C213152 | H685mm | £53.87 | £36.99 | £32.32 |



Storm High Chair

- Traditional looking high chair with large seat giving exceptional back support
- Very heavy duty frame with protective buffer feet
- Perfect for use in ICT, craft and science environments

| | | 1-5 | 6-29 | 30+ |
|---------|--------|--------|--------|--------|
| C213161 | H620mm | £57.74 | £39.65 | £38.49 |
| C213162 | H670mm | £64.75 | £44.46 | £41.01 |



Classic High Chair

- New stronger and sleeker design high chair
- Unique angled front foot rest
- 2 piece polypropylene construction provides excellent lumbar support
- Fully EN1729 compliant

| | | 1-5 | 6-29 | 30+ |
|---------|--------|--------|--------|--------|
| C213171 | H640mm | £57.74 | £39.65 | £36.57 |
| C213172 | H670mm | £64.75 | £44.46 | £38.85 |



Please Specify:

1. Seat colour
2. Frame colour

Frame Colours



Speckled Grey



Metallic Charcoal

Speckled Grey will be supplied if no colour is specified

Seat Colours



Blue



Charcoal



Green



Lilac



Orange



Purple



Red



Soft Blue



Tangy Lime



Yellow



CALL US ON 01527 878348



VISIT WWW.FORWARDPRODUCTS.CO.UK



Classroom Ultimate II Chair



Style Chair



Lumbar Chair



Classic High Chair



Classic Chair

Call for further details of our huge range of classroom seating



2

Classroom Tables

| | |
|-----------------------------------|-------|
| Classroom Tables | 28-41 |
| Craft Tables | 42-43 |
| Tilt Top Tables | 44 |
| Height Adjustable Tables | 45 |
| Wooden Locker Desks | 46 |
| Teacher's Desks | 47 |
| Exam Desks | 48 |
| Carrel Study Units & Workstations | 49 |



MDF Edge Classroom Tables

- These tables are proven in the education market and have passed FIRA tests for severe educational use
- Hardwearing laminated tops with bullnosed and lacquered MDF edges that cannot be picked
- **Please see Important Furniture Ordering Information on page 3 before placing your furniture order**

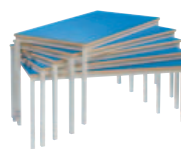

Fully welded frames - spiral stacking 5 high



Crushbent frames - slide stacking 8 high

Laminate Top Colours

Please Specify:

1. Top colour
2. Frame colour

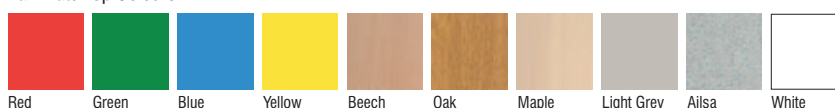

Frame Colours - Speckled Grey will be supplied if no colour is specified

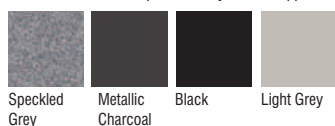

MDF Edge Detail



1200 x 600mm Rectangular



- Fully Welded Frame

| | | 1-2 | 3-14 | 15+ |
|---------|--------|--------|--------|--------|
| C211111 | H460mm | £75.43 | £51.29 | £49.26 |
| C211112 | H530mm | £75.43 | £51.29 | £49.26 |
| C211113 | H590mm | £75.43 | £51.29 | £49.26 |
| C211114 | H640mm | £75.43 | £51.29 | £49.26 |
| C211115 | H710mm | £75.43 | £51.29 | £49.26 |
| C211116 | H760mm | £75.43 | £51.29 | £49.26 |

- Crushbent Frame

| | | 1-2 | 3-14 | 15+ |
|---------|--------|--------|--------|--------|
| C211121 | H460mm | £75.43 | £51.29 | £49.26 |
| C211122 | H530mm | £75.43 | £51.29 | £49.26 |
| C211123 | H590mm | £75.43 | £51.29 | £49.26 |
| C211124 | H640mm | £75.43 | £51.29 | £49.26 |
| C211125 | H710mm | £75.43 | £51.29 | £49.26 |
| C211126 | H760mm | £75.43 | £51.29 | £49.26 |

1100 x 550mm Rectangular



- Fully Welded Frame

| | | 1-2 | 3-14 | 15+ |
|---------|--------|--------|--------|--------|
| C211131 | H460mm | £75.28 | £51.19 | £49.16 |
| C211132 | H530mm | £75.28 | £51.19 | £49.16 |
| C211133 | H590mm | £75.28 | £51.19 | £49.16 |
| C211134 | H640mm | £75.28 | £51.19 | £49.16 |
| C211135 | H710mm | £75.28 | £51.19 | £49.16 |
| C211136 | H760mm | £75.28 | £51.19 | £49.16 |

- Crushbent Frame

| | | 1-2 | 3-14 | 15+ |
|---------|--------|--------|--------|--------|
| C211141 | H460mm | £75.28 | £51.19 | £49.16 |
| C211142 | H530mm | £75.28 | £51.19 | £49.16 |
| C211143 | H590mm | £75.28 | £51.19 | £49.16 |
| C211144 | H640mm | £75.28 | £51.19 | £49.16 |
| C211145 | H710mm | £75.28 | £51.19 | £49.16 |
| C211146 | H760mm | £75.28 | £51.19 | £49.16 |

1100 x 550mm Trapezoidal



- Fully Welded Frame

| | | 1-2 | 3-14 | 15+ |
|---------|--------|--------|--------|--------|
| C211151 | H460mm | £75.49 | £51.33 | £49.31 |
| C211152 | H530mm | £75.49 | £51.33 | £49.31 |
| C211153 | H590mm | £75.49 | £51.33 | £49.31 |
| C211154 | H640mm | £75.49 | £51.33 | £49.31 |
| C211155 | H710mm | £75.49 | £51.33 | £49.31 |
| C211156 | H760mm | £75.49 | £51.33 | £49.31 |

- Crushbent Frame

| | | 1-2 | 3-14 | 15+ |
|---------|--------|--------|--------|--------|
| C211161 | H460mm | £75.49 | £51.33 | £49.31 |
| C211162 | H530mm | £75.49 | £51.33 | £49.31 |
| C211163 | H590mm | £75.49 | £51.33 | £49.31 |
| C211164 | H640mm | £75.49 | £51.33 | £49.31 |
| C211165 | H710mm | £75.49 | £51.33 | £49.31 |
| C211166 | H760mm | £75.49 | £51.33 | £49.31 |

Also available in 1200 x 600mm, please call for details



600 x 600mm Square

- Fully Welded Frame

| | | 1-2 | 3-14 | 15+ |
|---------|--------|--------|--------|--------|
| C211171 | H460mm | £62.38 | £42.42 | £40.74 |
| C211172 | H530mm | £62.38 | £42.42 | £40.74 |
| C211173 | H590mm | £62.38 | £42.42 | £40.74 |
| C211174 | H640mm | £62.38 | £42.42 | £40.74 |
| C211175 | H710mm | £62.38 | £42.42 | £40.74 |
| C211176 | H760mm | £62.38 | £42.42 | £40.74 |

- Crushbent Frame

| | | 1-2 | 3-14 | 15+ |
|---------|--------|--------|--------|--------|
| C211181 | H460mm | £62.38 | £42.42 | £40.74 |
| C211182 | H530mm | £62.38 | £42.42 | £40.74 |
| C211183 | H590mm | £62.38 | £42.42 | £40.74 |
| C211184 | H640mm | £62.38 | £42.42 | £40.74 |
| C211185 | H710mm | £62.38 | £42.42 | £40.74 |
| C211186 | H760mm | £62.38 | £42.42 | £40.74 |



1000mm Diameter Circular

- Circular tables not stackable
- Fully Welded Frame

| | | 1-2 | 3-14 | 15+ |
|---------|--------|---------|--------|--------|
| C211191 | H460mm | £117.92 | £80.18 | £76.64 |
| C211192 | H530mm | £117.92 | £80.18 | £76.64 |
| C211193 | H590mm | £117.92 | £80.18 | £76.64 |
| C211194 | H640mm | £117.92 | £80.18 | £76.64 |
| C211195 | H710mm | £117.92 | £80.18 | £76.64 |
| C211196 | H760mm | £117.92 | £80.18 | £76.64 |

- Crushbent Frame

| | | 1-2 | 3-14 | 15+ |
|---------|--------|---------|--------|--------|
| C211211 | H460mm | £117.92 | £80.18 | £76.64 |
| C211212 | H530mm | £117.92 | £80.18 | £76.64 |
| C211213 | H590mm | £117.92 | £80.18 | £76.64 |
| C211214 | H640mm | £117.92 | £80.18 | £76.64 |
| C211215 | H710mm | £117.92 | £80.18 | £76.64 |
| C211216 | H760mm | £117.92 | £80.18 | £76.64 |



Also available in 1100mm and 1200mm diameter, please call for details

1200 x 600mm Diameter Semi-Circular

- Fully Welded Frame

| | | 1-2 | 3-14 | 15+ |
|---------|--------|---------|--------|--------|
| C211221 | H460mm | £102.30 | £68.20 | £62.85 |
| C211222 | H530mm | £102.30 | £68.20 | £62.85 |
| C211223 | H590mm | £102.30 | £68.20 | £62.85 |
| C211224 | H640mm | £102.30 | £68.20 | £62.85 |
| C211225 | H710mm | £102.30 | £68.20 | £62.85 |
| C211226 | H760mm | £102.30 | £68.20 | £62.85 |

- Crushbent Frame

| | | 1-2 | 3-14 | 15+ |
|---------|--------|---------|--------|--------|
| C211231 | H460mm | £102.30 | £68.20 | £62.85 |
| C211232 | H530mm | £102.30 | £68.20 | £62.85 |
| C211233 | H590mm | £102.30 | £68.20 | £62.85 |
| C211234 | H640mm | £102.30 | £68.20 | £62.85 |
| C211235 | H710mm | £102.30 | £68.20 | £62.85 |
| C211236 | H760mm | £102.30 | £68.20 | £62.85 |



1100 x 550mm Diameter Semi-Circular

- Fully Welded Frame

| | | 1-2 | 3-14 | 15+ |
|---------|--------|---------|--------|--------|
| C211241 | H460mm | £102.30 | £68.20 | £62.85 |
| C211242 | H530mm | £102.30 | £68.20 | £62.85 |
| C211243 | H590mm | £102.30 | £68.20 | £62.85 |
| C211244 | H640mm | £102.30 | £68.20 | £62.85 |
| C211245 | H710mm | £102.30 | £68.20 | £62.85 |
| C211246 | H760mm | £102.30 | £68.20 | £62.85 |

- Crushbent Frame

| | | 1-2 | 3-14 | 15+ |
|---------|--------|---------|--------|--------|
| C211251 | H460mm | £102.30 | £68.20 | £62.85 |
| C211252 | H530mm | £102.30 | £68.20 | £62.85 |
| C211253 | H590mm | £102.30 | £68.20 | £62.85 |
| C211254 | H640mm | £102.30 | £68.20 | £62.85 |
| C211255 | H710mm | £102.30 | £68.20 | £62.85 |
| C211256 | H760mm | £102.30 | £68.20 | £62.85 |



The guides below show the measurements of each sizemark and age and stature ranges they are suitable for. This information is for guidance only. It is based on average pupil size across the EU.

Customers must ensure sizes are correct for their individual requirements

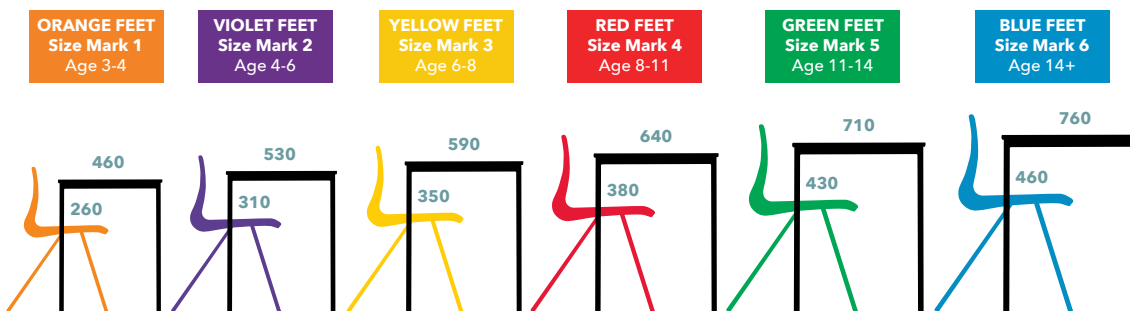

Table/chair sizes may vary slightly from the sizes shown. The standard allows heights to be within a 10mm tolerance.



PU Edge Classroom Tables

- Advanced impact resistant and waterproof PU textured edges
- FIRA rated for severe educational use
- Durable laminated tops with moulded PU edges
- **Please see Important Furniture Ordering Information on page 3 before placing your furniture order**

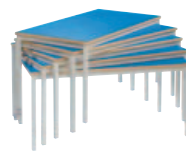

Fully welded frames - spiral stacking 5 high



Crushbent frames - slide stacking 8 high

Please Specify:

1. Top colour
2. Edge colour
3. Frame colour

Laminate Top Colours

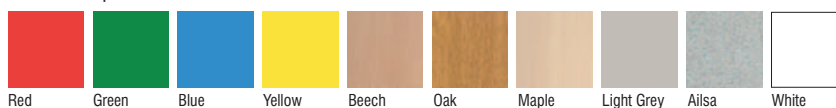

PU Edge Colours



Frame Colours - Speckled Grey will be supplied if no colour is specified

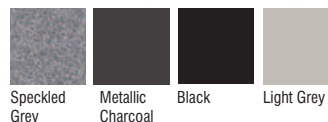

PU Edge Detail



1200 x 600mm Rectangular



- Fully Welded Frame

| | | 1-2 | 3-14 | 15+ |
|---------|--------|--------|--------|--------|
| C211421 | H460mm | £91.72 | £62.37 | £59.61 |
| C211422 | H530mm | £91.72 | £62.37 | £59.61 |
| C211423 | H590mm | £91.72 | £62.37 | £59.61 |
| C211424 | H640mm | £91.72 | £62.37 | £59.61 |
| C211425 | H710mm | £91.72 | £62.37 | £59.61 |
| C211426 | H760mm | £91.72 | £62.37 | £59.61 |

- Crushbent Frame

| | | 1-2 | 3-14 | 15+ |
|---------|--------|--------|--------|--------|
| C211431 | H460mm | £91.72 | £62.37 | £59.61 |
| C211432 | H530mm | £91.72 | £62.37 | £59.61 |
| C211433 | H590mm | £91.72 | £62.37 | £59.61 |
| C211434 | H640mm | £91.72 | £62.37 | £59.61 |
| C211435 | H710mm | £91.72 | £62.37 | £59.61 |
| C211436 | H760mm | £91.72 | £62.37 | £59.61 |

1100 x 550mm Rectangular



- Fully Welded Frame

| | | 1-2 | 3-14 | 15+ |
|---------|--------|--------|--------|--------|
| C211441 | H460mm | £91.49 | £62.22 | £59.56 |
| C211442 | H530mm | £91.49 | £62.22 | £59.56 |
| C211443 | H590mm | £91.49 | £62.22 | £59.56 |
| C211444 | H640mm | £91.49 | £62.22 | £59.56 |
| C211445 | H710mm | £91.49 | £62.22 | £59.56 |
| C211446 | H760mm | £91.49 | £62.22 | £59.56 |

- Crushbent Frame

| | | 1-2 | 3-14 | 15+ |
|---------|--------|--------|--------|--------|
| C211451 | H460mm | £91.49 | £62.22 | £59.56 |
| C211452 | H530mm | £91.49 | £62.22 | £59.56 |
| C211453 | H590mm | £91.49 | £62.22 | £59.56 |
| C211454 | H640mm | £91.49 | £62.22 | £59.56 |
| C211455 | H710mm | £91.49 | £62.22 | £59.56 |
| C211456 | H760mm | £91.49 | £62.22 | £59.56 |

1100 x 550mm Trapezoidal



- Fully Welded Frame

| | | 1-2 | 3-14 | 15+ |
|---------|--------|--------|--------|--------|
| C211461 | H460mm | £97.09 | £66.02 | £63.09 |
| C211462 | H530mm | £97.09 | £66.02 | £63.09 |
| C211463 | H590mm | £97.09 | £66.02 | £63.09 |
| C211464 | H640mm | £97.09 | £66.02 | £63.09 |
| C211465 | H710mm | £97.09 | £66.02 | £63.09 |
| C211466 | H760mm | £97.09 | £66.02 | £63.09 |

- Crushbent Frame

| | | 1-2 | 3-14 | 15+ |
|---------|--------|--------|--------|--------|
| C211471 | H460mm | £97.09 | £66.02 | £63.09 |
| C211472 | H530mm | £97.09 | £66.02 | £63.09 |
| C211473 | H590mm | £97.09 | £66.02 | £63.09 |
| C211474 | H640mm | £97.09 | £66.02 | £63.09 |
| C211475 | H710mm | £97.09 | £66.02 | £63.09 |
| C211476 | H760mm | £97.09 | £66.02 | £63.09 |



600 x 600mm Square

- Fully Welded Frame

| | | 1-2 | 3-14 | 15+ |
|---------|--------|--------|--------|--------|
| C211481 | H460mm | £78.00 | £53.04 | £50.69 |
| C211482 | H530mm | £78.00 | £53.04 | £50.69 |
| C211483 | H590mm | £78.00 | £53.04 | £50.69 |
| C211484 | H640mm | £78.00 | £53.04 | £50.69 |
| C211485 | H710mm | £78.00 | £53.04 | £50.69 |
| C211486 | H760mm | £78.00 | £53.04 | £50.69 |

- Crushbent Frame

| | | 1-2 | 3-14 | 15+ |
|---------|--------|--------|--------|--------|
| C211491 | H460mm | £78.00 | £53.04 | £50.69 |
| C211492 | H530mm | £78.00 | £53.04 | £50.69 |
| C211493 | H590mm | £78.00 | £53.04 | £50.69 |
| C211494 | H640mm | £78.00 | £53.04 | £50.69 |
| C211495 | H710mm | £78.00 | £53.04 | £50.69 |
| C211496 | H760mm | £78.00 | £53.04 | £50.69 |



1000mm Diameter Circular

- Circular tables not stackable

- Fully Welded Frame

| | | 1-2 | 3-14 | 15+ |
|---------|--------|---------|--------|--------|
| C211511 | H460mm | £136.48 | £92.80 | £88.70 |
| C211512 | H530mm | £136.48 | £92.80 | £88.70 |
| C211513 | H590mm | £136.48 | £92.80 | £88.70 |
| C211514 | H640mm | £136.48 | £92.80 | £88.70 |
| C211515 | H710mm | £136.48 | £92.80 | £88.70 |
| C211516 | H760mm | £136.48 | £92.80 | £88.70 |

- Crushbent Frame

| | | 1-2 | 3-14 | 15+ |
|---------|--------|---------|--------|--------|
| C211521 | H460mm | £136.48 | £92.80 | £88.70 |
| C211522 | H530mm | £136.48 | £92.80 | £88.70 |
| C211523 | H590mm | £136.48 | £92.80 | £88.70 |
| C211524 | H640mm | £136.48 | £92.80 | £88.70 |
| C211525 | H710mm | £136.48 | £92.80 | £88.70 |
| C211526 | H760mm | £136.48 | £92.80 | £88.70 |



Also available in 1100mm and 1200mm diameter, please call for details

1200 x 600mm Diameter Semi-Circular

- Fully Welded Frame

| | | 1-2 | 3-14 | 15+ |
|---------|--------|---------|--------|--------|
| C211531 | H460mm | £118.44 | £80.54 | £76.97 |
| C211532 | H530mm | £118.44 | £80.54 | £76.97 |
| C211533 | H590mm | £118.44 | £80.54 | £76.97 |
| C211534 | H640mm | £118.44 | £80.54 | £76.97 |
| C211535 | H710mm | £118.44 | £80.54 | £76.97 |
| C211536 | H760mm | £118.44 | £80.54 | £76.97 |

- Crushbent Frame

| | | 1-2 | 3-14 | 15+ |
|---------|--------|---------|--------|--------|
| C211541 | H460mm | £118.44 | £80.54 | £76.97 |
| C211542 | H530mm | £118.44 | £80.54 | £76.97 |
| C211543 | H590mm | £118.44 | £80.54 | £76.97 |
| C211544 | H640mm | £118.44 | £80.54 | £76.97 |
| C211545 | H710mm | £118.44 | £80.54 | £76.97 |
| C211546 | H760mm | £118.44 | £80.54 | £76.97 |



1100 x 550mm Diameter Semi-Circular

- Fully Welded Frame

| | | 1-2 | 3-14 | 15+ |
|---------|--------|---------|--------|--------|
| C211551 | H460mm | £116.17 | £79.00 | £75.51 |
| C211552 | H530mm | £116.17 | £79.00 | £75.51 |
| C211553 | H590mm | £116.17 | £79.00 | £75.51 |
| C211554 | H640mm | £116.17 | £79.00 | £75.51 |
| C211555 | H710mm | £116.17 | £79.00 | £75.51 |
| C211556 | H760mm | £116.17 | £79.00 | £75.51 |

- Crushbent Frame

| | | 1-2 | 3-14 | 15+ |
|---------|--------|---------|--------|--------|
| C211561 | H460mm | £116.17 | £79.00 | £75.51 |
| C211562 | H530mm | £116.17 | £79.00 | £75.51 |
| C211563 | H590mm | £116.17 | £79.00 | £75.51 |
| C211564 | H640mm | £116.17 | £79.00 | £75.51 |
| C211565 | H710mm | £116.17 | £79.00 | £75.51 |
| C211566 | H760mm | £116.17 | £79.00 | £75.51 |



The guides below show the measurements of each sizemark and age and stature ranges they are suitable for. This information is for guidance only. It is based on average pupil size across the EU.

Customers must ensure sizes are correct for their individual requirements

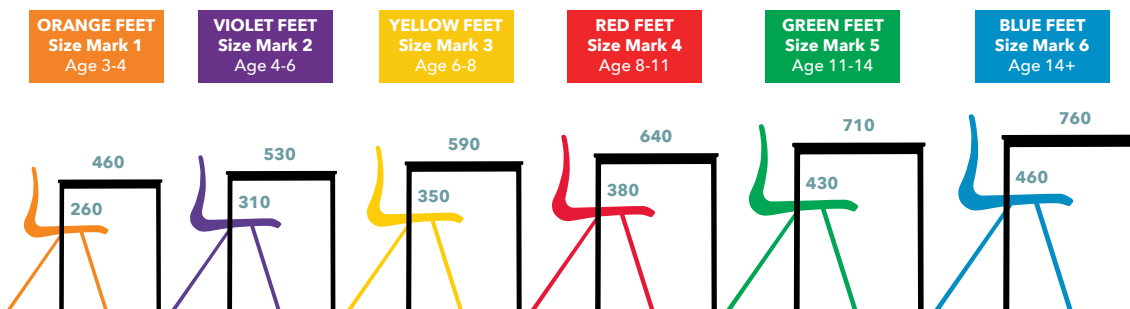

Table/chair sizes may vary slightly from the sizes shown. The standard allows heights to be within a 10mm tolerance.



Welded Frame Classroom Tray Tables

- The same quality tables as the preceding ranges, tray tables are fitted with runners and pull out trays providing individual storage for students
- Trays give extra scope for attractive colour schemes - see below for tray colour options
- Please check pupils will have sufficient leg room under tray tables; you may wish to move up a size
- **Please see Important Furniture Ordering Information on page 3 before placing your furniture order**

Please Specify:

1. Top colour
2. Edge type & colour
3. Frame colour
4. Tray colour

Laminate Top Colours

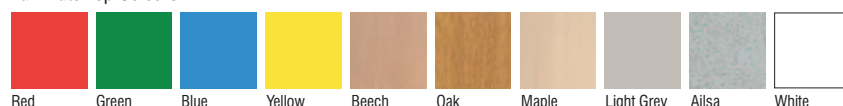

Tray Colour Options



PU Edge Colours



Frame Colours



1200 x 600mm Rectangular

- MDF Edge

| | | 1-2 | 3-14 | 15+ |
|---------|--------|---------|--------|--------|
| C211571 | H460mm | £110.86 | £75.39 | £72.05 |
| C211572 | H530mm | £110.86 | £75.39 | £72.05 |
| C211573 | H590mm | £110.86 | £75.39 | £72.05 |
| C211574 | H640mm | £110.86 | £75.39 | £72.05 |
| C211575 | H710mm | £110.86 | £75.39 | £72.05 |
| C211576 | H760mm | £110.86 | £75.39 | £72.05 |

- PU Edge

| | | 1-2 | 3-14 | 15+ |
|---------|--------|---------|--------|--------|
| C211591 | H460mm | £127.89 | £86.97 | £83.12 |
| C211592 | H530mm | £127.89 | £86.97 | £83.12 |
| C211593 | H590mm | £127.89 | £86.97 | £83.12 |
| C211594 | H640mm | £127.89 | £86.97 | £83.12 |
| C211595 | H710mm | £127.89 | £86.97 | £83.12 |
| C211596 | H760mm | £127.89 | £86.97 | £83.12 |

1100 x 550mm Rectangular

- MDF Edge

| | | 1-2 | 3-14 | 15+ |
|---------|--------|---------|--------|--------|
| C211611 | H460mm | £111.61 | £75.90 | £72.54 |
| C211612 | H530mm | £111.61 | £75.90 | £72.54 |
| C211613 | H590mm | £111.61 | £75.90 | £72.54 |
| C211614 | H640mm | £111.61 | £75.90 | £72.54 |
| C211615 | H710mm | £111.61 | £75.90 | £72.54 |
| C211616 | H760mm | £111.61 | £75.90 | £72.54 |

- PU Edge

| | | 1-2 | 3-14 | 15+ |
|---------|--------|---------|--------|--------|
| C211631 | H460mm | £127.89 | £86.97 | £83.12 |
| C211632 | H530mm | £127.89 | £86.97 | £83.12 |
| C211633 | H590mm | £127.89 | £86.97 | £83.12 |
| C211634 | H640mm | £127.89 | £86.97 | £83.12 |
| C211635 | H710mm | £127.89 | £86.97 | £83.12 |
| C211636 | H760mm | £127.89 | £86.97 | £83.12 |

600 x 600mm Square

- MDF Edge

| | | 1-2 | 3-14 | 15+ |
|---------|--------|--------|--------|--------|
| C211641 | H460mm | £83.20 | £56.58 | £54.07 |
| C211642 | H530mm | £83.20 | £56.58 | £54.07 |
| C211643 | H590mm | £83.20 | £56.58 | £54.07 |
| C211644 | H640mm | £83.20 | £56.58 | £54.07 |
| C211645 | H710mm | £83.20 | £56.58 | £54.07 |
| C211646 | H760mm | £83.20 | £56.58 | £54.07 |

- PU Edge

| | | 1-2 | 3-14 | 15+ |
|---------|--------|--------|--------|--------|
| C211661 | H460mm | £95.35 | £64.84 | £61.97 |
| C211662 | H530mm | £95.35 | £64.84 | £61.97 |
| C211663 | H590mm | £95.35 | £64.84 | £61.97 |
| C211664 | H640mm | £95.35 | £64.84 | £61.97 |
| C211665 | H710mm | £95.35 | £64.84 | £61.97 |
| C211666 | H760mm | £95.35 | £64.84 | £61.97 |



Express Delivery Classroom Tables

- High quality UK manufactured tables
- 32mm diameter, stylish round tube legs in grey finish
- EN1729 compliant
- Heights 710mm or 760mm
- MDF edge and PU edge options
- Standard delivery 1-2 weeks, please check at time of ordering
- **Please see Important Furniture Ordering Information on page 3 before placing your furniture order**



Please Specify:

Top colour

Top Colours



Express
1-2 week
delivery



Grade Rectangular MDF Edge

- 18mm laminated top, MDF edge
- 1200 x 600mm
- 10 year guarantee

| | | 1-2 | 3-14 | 15+ |
|---------|-------------------|--------|--------|--------|
| C211671 | H710mm, Beech Top | £86.62 | £67.96 | £61.17 |
| C211672 | H710mm, Grey Top | £86.62 | £67.96 | £61.17 |
| C211673 | H760mm, Beech Top | £86.62 | £67.96 | £61.17 |
| C211674 | H760mm, Grey Top | £86.62 | £67.96 | £61.17 |



Grade Square MDF Edge

- 18mm laminated top, MDF edge
- 600 x 600mm
- 10 year guarantee

| | | 1-2 | 3-14 | 15+ |
|---------|-------------------|--------|--------|--------|
| C211681 | H110mm, Beech Top | £69.55 | £54.57 | £49.11 |
| C211682 | H710mm, Grey Top | £69.55 | £54.57 | £49.11 |
| C211683 | H760mm, Beech Top | £69.55 | £54.57 | £49.11 |
| C211684 | H760mm, Grey Top | £69.55 | £54.57 | £49.11 |

Grade Rectangular PU Edge

- 18mm laminated top, grey spray PU edge
- 1200 x 600mm
- 10 year guarantee

| | | 1-2 | 3-14 | 15+ |
|---------|-------------------|--------|--------|--------|
| C211691 | H710mm, Beech Top | £89.01 | £69.83 | £62.85 |
| C211692 | H710mm, Grey Top | £89.01 | £69.83 | £62.85 |
| C211693 | H760mm, Beech Top | £89.01 | £69.83 | £62.85 |
| C211694 | H760mm, Grey Top | £89.01 | £69.83 | £62.85 |

Grade Square PU Edge

- 18mm laminated top, grey spray PU edge
- 600 x 600mm
- 10 year guarantee

| | | 1-2 | 3-14 | 15+ |
|---------|-------------------|--------|--------|--------|
| C211711 | H710mm, Beech Top | £76.51 | £60.03 | £54.03 |
| C211712 | H710mm, Grey Top | £76.51 | £60.03 | £54.03 |
| C211713 | H760mm, Beech Top | £76.51 | £60.03 | £54.03 |
| C211714 | H760mm, Grey Top | £76.51 | £60.03 | £54.03 |



Ultimate Classroom Tables

- Premium quality crushbent frame tables
- Solid 18mm MDF core high pressure laminated tops
- High impact, resilient textured spray PU edge with a unique waterfall shaped finish
- Robust 28mm stacking crushbent frames
- 5 year guarantee
- **Please see Important Furniture Ordering Information on page 3 before placing your furniture order**

Crushbent frames - slide stacking 8 high



Please Specify:

1. Top colour
2. Edge colour
3. Frame colour

Laminate Top Colours

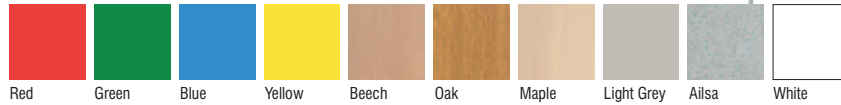

PU Edge Colours

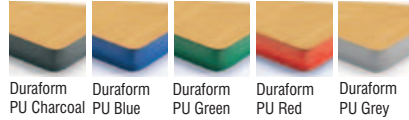

Frame Colours

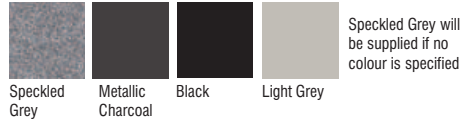

1200 x 600mm Rectangular

| | | 1-2 | 3-14 | 15+ |
|---------|--------|---------|--------|--------|
| C211721 | H460mm | £128.84 | £87.61 | £83.74 |
| C211722 | H530mm | £128.84 | £87.61 | £83.74 |
| C211723 | H590mm | £128.84 | £87.61 | £83.74 |
| C211724 | H640mm | £128.84 | £87.61 | £83.74 |
| C211725 | H710mm | £128.84 | £87.61 | £83.74 |
| C211726 | H760mm | £128.84 | £87.61 | £83.74 |

1200 x 600mm Trapezoidal

| | | 1-2 | 3-14 | 15+ |
|---------|--------|---------|--------|--------|
| C211731 | H460mm | £132.15 | £89.86 | £85.88 |
| C211732 | H530mm | £132.15 | £89.86 | £85.88 |
| C211733 | H590mm | £132.15 | £89.86 | £85.88 |
| C211734 | H640mm | £132.15 | £89.86 | £85.88 |
| C211735 | H710mm | £132.15 | £89.86 | £85.88 |
| C211736 | H760mm | £132.15 | £89.86 | £85.88 |

600 x 600mm Square

| | | 1-2 | 3-14 | 15+ |
|---------|--------|--------|--------|--------|
| C211741 | H460mm | £97.61 | £66.38 | £63.43 |
| C211742 | H530mm | £97.61 | £66.38 | £63.43 |
| C211743 | H590mm | £97.61 | £66.38 | £63.43 |
| C211744 | H640mm | £97.61 | £66.38 | £63.43 |
| C211745 | H710mm | £97.61 | £66.38 | £63.43 |
| C211746 | H760mm | £97.61 | £66.38 | £63.43 |

1000mm Diameter Circular

| | | 1-2 | 3-14 | 15+ |
|---------|--------|---------|---------|---------|
| C211751 | H460mm | £173.44 | £117.94 | £112.72 |
| C211752 | H530mm | £173.44 | £117.94 | £112.72 |
| C211753 | H590mm | £173.44 | £117.94 | £112.72 |
| C211754 | H640mm | £173.44 | £117.94 | £112.72 |
| C211755 | H710mm | £173.44 | £117.94 | £112.72 |
| C211756 | H760mm | £173.44 | £117.94 | £112.72 |





Premium Early Years Tables

- Chunky design and bright colours, ideal for nursery and primary classrooms
- Highest quality fully welded tables with stylish, chunky 45mm tubular legs
- Standard 18mm tops in hard wearing laminate with MDF bullnosed edges
- Exceptional strength and style vastly superior to bolt-on and screw-on leg systems
- Primary colours will be supplied with a matching frame if no colour is specified
- **Please see Important Furniture Ordering Information on page 3 before placing your furniture order**

FULLY EN1729 COMPLIANT



10 YEAR GUARANTEE

| Rectangular | | 1-2 | 3-14 | 15+ |
|-------------|---------------------|---------|--------|--------|
| C211761 | 1100 x 550 x H460mm | £127.46 | £86.68 | £84.49 |
| C211762 | 1100 x 550 x H530mm | £127.46 | £86.68 | £84.49 |
| C211763 | 1100 x 550 x H590mm | £127.46 | £86.68 | £84.49 |

| Trapezoidal | | 1-2 | 3-14 | 15+ |
|-------------|---------------------|---------|--------|--------|
| C211764 | 1100 x 550 x H460mm | £133.60 | £90.85 | £88.55 |
| C211765 | 1100 x 550 x H530mm | £133.60 | £90.85 | £88.55 |
| C211766 | 1100 x 550 x H590mm | £133.60 | £90.85 | £88.55 |

| Circular | | 1-2 | 3-14 | 15+ |
|----------|--------------------|---------|---------|---------|
| C211767 | 1100 dia. x H460mm | £177.95 | £121.01 | £117.95 |
| C211768 | 1100 dia. x H530mm | £177.95 | £121.01 | £117.95 |
| C211769 | 1100 dia. x H590mm | £177.95 | £121.01 | £117.95 |

- PU edges also available, please call for prices

Please Specify:

1. Top colour
2. Frame colour

Laminate Top Colours supplied with matching colour frames

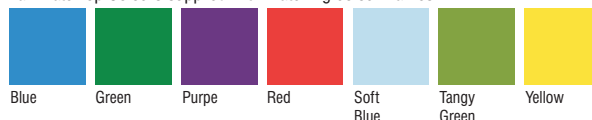

Laminate Top Colours supplied with Duraform Light Speckled Grey Frame



Frame Colour



CALL US ON 01527 878348



VISIT WWW.FORWARDPRODUCTS.CO.UK



Dura Premium Tables

- High quality fully welded tables with stylish 32mm legs
- Exceptional strength and style vastly superior to bolt-on and screw-on leg systems
- Hardwearing 18mm laminated tops
- Choose from a lacquered, bullnosed MDF edge or spray moulded PU edge
- 5 year guarantee
- **Please see Important Furniture Ordering Information on page 3 before placing your furniture order**

Please Specify:

1. Top colour
2. Edge colour
3. Frame colour

Laminate Top Colours

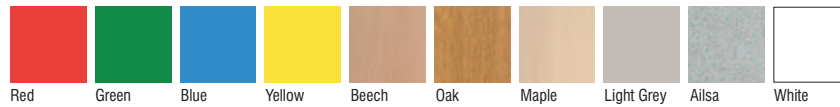

PU Edge Colours

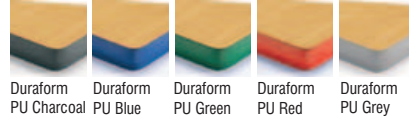

Frame Colours

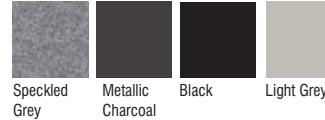

Speckled Grey will be supplied if no colour is specified

1200 x 600mm Rectangular



MDF Edge

| | | 1-2 | 3-14 | 15+ |
|---------|--------|--------|--------|--------|
| C211771 | H460mm | £87.22 | £65.42 | £58.00 |
| C211772 | H530mm | £87.22 | £65.42 | £58.00 |
| C211773 | H590mm | £87.22 | £65.42 | £58.00 |
| C211774 | H640mm | £87.22 | £65.42 | £58.00 |
| C211775 | H710mm | £87.22 | £65.42 | £58.00 |
| C211776 | H760mm | £87.22 | £65.42 | £58.00 |

PU Edge

| | | 1-2 | 3-14 | 15+ |
|---------|--------|---------|--------|--------|
| C211781 | H460mm | £101.79 | £76.34 | £67.69 |
| C211782 | H530mm | £101.79 | £76.34 | £67.69 |
| C211783 | H590mm | £101.79 | £76.34 | £67.69 |
| C211784 | H640mm | £101.79 | £76.34 | £67.69 |
| C211785 | H710mm | £101.79 | £76.34 | £67.69 |
| C211786 | H760mm | £101.79 | £76.34 | £67.69 |

1100 x 550mm Rectangular



MDF Edge

| | | 1-2 | 3-14 | 15+ |
|---------|--------|--------|--------|--------|
| C211791 | H460mm | £87.22 | £65.42 | £58.00 |
| C211792 | H530mm | £87.22 | £65.42 | £58.00 |
| C211793 | H590mm | £87.22 | £65.42 | £58.00 |
| C211794 | H640mm | £87.22 | £65.42 | £58.00 |
| C211795 | H710mm | £87.22 | £65.42 | £58.00 |
| C211796 | H760mm | £87.22 | £65.42 | £58.00 |

PU Edge

| | | 1-2 | 3-14 | 15+ |
|---------|--------|---------|--------|--------|
| C211811 | H460mm | £101.79 | £76.34 | £67.69 |
| C211812 | H530mm | £101.79 | £76.34 | £67.69 |
| C211813 | H590mm | £101.79 | £76.34 | £67.69 |
| C211814 | H640mm | £101.79 | £76.34 | £67.69 |
| C211815 | H710mm | £101.79 | £76.34 | £67.69 |
| C211816 | H760mm | £101.79 | £76.34 | £67.69 |

1100 x 550mm Trapezoidal



MDF Edge

| | | 1-2 | 3-14 | 15+ |
|---------|--------|--------|--------|--------|
| C211821 | H460mm | £87.22 | £65.42 | £58.00 |
| C211822 | H530mm | £87.22 | £65.42 | £58.00 |
| C211823 | H590mm | £87.22 | £65.42 | £58.00 |
| C211824 | H640mm | £87.22 | £65.42 | £58.00 |
| C211825 | H710mm | £87.22 | £65.42 | £58.00 |
| C211826 | H760mm | £87.22 | £65.42 | £58.00 |

PU Edge

| | | 1-2 | 3-14 | 15+ |
|---------|--------|---------|--------|--------|
| C211831 | H460mm | £101.79 | £76.34 | £67.69 |
| C211832 | H530mm | £101.79 | £76.34 | £67.69 |
| C211833 | H590mm | £101.79 | £76.34 | £67.69 |
| C211834 | H640mm | £101.79 | £76.34 | £67.69 |
| C211835 | H710mm | £101.79 | £76.34 | £67.69 |
| C211836 | H760mm | £101.79 | £76.34 | £67.69 |





600 x 600mm Square

MDF Edge

| | | 1-2 | 3-14 | 15+ |
|---------|--------|--------|--------|--------|
| C211841 | H460mm | £67.60 | £45.96 | £44.80 |
| C211842 | H530mm | £67.60 | £45.96 | £44.80 |
| C211843 | H590mm | £67.60 | £45.96 | £44.80 |
| C211844 | H640mm | £67.60 | £45.96 | £44.80 |
| C211845 | H710mm | £67.60 | £45.96 | £44.80 |
| C211846 | H760mm | £67.60 | £45.96 | £44.80 |

PU Edge

| | | 1-2 | 3-14 | 15+ |
|---------|--------|--------|--------|--------|
| C211851 | H460mm | £86.34 | £58.71 | £57.22 |
| C211852 | H530mm | £86.34 | £58.71 | £57.22 |
| C211853 | H590mm | £86.34 | £58.71 | £57.22 |
| C211854 | H640mm | £86.34 | £58.71 | £57.22 |
| C211855 | H710mm | £86.34 | £58.71 | £57.22 |
| C211856 | H760mm | £86.34 | £58.71 | £57.22 |



1200mm Diameter Circular

MDF Edge

| | | 1-2 | 3-14 | 15+ |
|---------|--------|---------|---------|---------|
| C211861 | H460mm | £155.92 | £115.68 | £107.33 |
| C211862 | H530mm | £155.92 | £115.68 | £107.33 |
| C211863 | H590mm | £155.92 | £115.68 | £107.33 |
| C211864 | H640mm | £155.92 | £115.68 | £107.33 |
| C211865 | H710mm | £155.92 | £115.68 | £107.33 |
| C211866 | H760mm | £155.92 | £115.68 | £107.33 |

PU Edge

| | | 1-2 | 3-14 | 15+ |
|---------|--------|---------|---------|---------|
| C211871 | H460mm | £188.28 | £128.03 | £124.80 |
| C211872 | H530mm | £188.28 | £128.03 | £124.80 |
| C211873 | H590mm | £188.28 | £128.03 | £124.80 |
| C211874 | H640mm | £188.28 | £128.03 | £124.80 |
| C211875 | H710mm | £188.28 | £128.03 | £124.80 |
| C211876 | H760mm | £188.28 | £128.03 | £124.80 |



Also available in 1100mm diameter, please call for details

1200 x 600mm Diameter Semi-Circular

MDF Edge

| | | 1-2 | 3-14 | 15+ |
|---------|--------|--------|--------|--------|
| C211881 | H460mm | £92.41 | £62.84 | £61.25 |
| C211882 | H530mm | £92.41 | £62.84 | £61.25 |
| C211883 | H590mm | £92.41 | £62.84 | £61.25 |
| C211884 | H640mm | £92.41 | £62.84 | £61.25 |
| C211885 | H710mm | £92.41 | £62.84 | £61.25 |
| C211886 | H760mm | £92.41 | £62.84 | £61.25 |

PU Edge

| | | 1-2 | 3-14 | 15+ |
|---------|--------|---------|--------|--------|
| C211891 | H460mm | £115.25 | £78.37 | £76.39 |
| C211892 | H530mm | £115.25 | £78.37 | £76.39 |
| C211893 | H590mm | £115.25 | £78.37 | £76.39 |
| C211894 | H640mm | £115.25 | £78.37 | £76.39 |
| C211895 | H710mm | £115.25 | £78.37 | £76.39 |
| C211896 | H760mm | £115.25 | £78.37 | £76.39 |



1100 x 550mm Diameter Semi-Circular

MDF Edge

| | | 1-2 | 3-14 | 15+ |
|---------|--------|--------|--------|--------|
| C211911 | H460mm | £92.41 | £62.84 | £61.25 |
| C211912 | H530mm | £92.41 | £62.84 | £61.25 |
| C211913 | H590mm | £92.41 | £62.84 | £61.25 |
| C211914 | H640mm | £92.41 | £62.84 | £61.25 |
| C211915 | H710mm | £92.41 | £62.84 | £61.25 |
| C211916 | H760mm | £92.41 | £62.84 | £61.25 |

PU Edge

| | | 1-2 | 3-14 | 15+ |
|---------|--------|---------|--------|--------|
| C211921 | H460mm | £110.10 | £74.87 | £72.99 |
| C211922 | H530mm | £110.10 | £74.87 | £72.99 |
| C211923 | H590mm | £110.10 | £74.87 | £72.99 |
| C211924 | H640mm | £110.10 | £74.87 | £72.99 |
| C211925 | H710mm | £110.10 | £74.87 | £72.99 |
| C211926 | H760mm | £110.10 | £74.87 | £72.99 |





Spectrum Heavy Duty Tables

- Stylish tables built to withstand high levels of wear and tear
- Premium 25mm thick top with spray PU edges
- 32mm tubular curved leg frames with height adjustable feet and tamperproof fixings
- 10 year guarantee
- **Please see Important Furniture Ordering Information on page 3 before placing your furniture order**

Please Specify:

1. Top colour
2. Edge colour
3. Frame colour

Laminate Top Colours

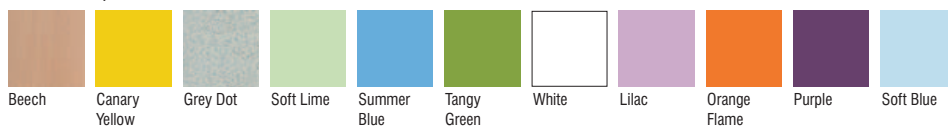

PU Edge Colours



Frame Colours

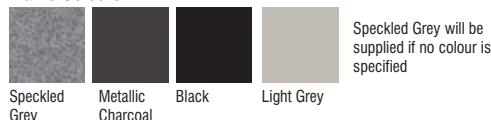

Please call for prices on bulk quantities



1100 x 550mm Rectangular

| | | 1-2 | 3-14 | 15+ |
|---------|--------|---------|---------|---------|
| C211931 | H460mm | £154.36 | £104.97 | £101.81 |
| C211932 | H530mm | £154.36 | £104.97 | £101.81 |
| C211933 | H590mm | £154.36 | £104.97 | £101.81 |
| C211934 | H640mm | £154.36 | £104.97 | £101.81 |
| C211935 | H710mm | £154.36 | £104.97 | £101.81 |
| C211936 | H760mm | £154.36 | £104.97 | £101.81 |

1200 x 600mm Rectangular

| | | 1-2 | 3-14 | 15+ |
|---------|--------|---------|---------|---------|
| C211941 | H460mm | £156.09 | £106.14 | £102.96 |
| C211942 | H530mm | £156.09 | £106.14 | £102.96 |
| C211943 | H590mm | £156.09 | £106.14 | £102.96 |
| C211944 | H640mm | £156.09 | £106.14 | £102.96 |
| C211945 | H710mm | £156.09 | £106.14 | £102.96 |
| C211946 | H760mm | £156.09 | £106.14 | £102.96 |

1100 x 550mm Trapezoidal

| | | 1-2 | 3-14 | 15+ |
|---------|--------|---------|---------|---------|
| C211951 | H460mm | £154.36 | £104.97 | £101.81 |
| C211952 | H530mm | £154.36 | £104.97 | £101.81 |
| C211953 | H590mm | £154.36 | £104.97 | £101.81 |
| C211954 | H640mm | £154.36 | £104.97 | £101.81 |
| C211955 | H710mm | £154.36 | £104.97 | £101.81 |
| C211956 | H760mm | £154.36 | £104.97 | £101.81 |

1200 x 600mm Trapezoidal

| | | 1-2 | 3-14 | 15+ |
|---------|--------|---------|---------|---------|
| C211961 | H460mm | £156.09 | £106.14 | £102.96 |
| C211962 | H530mm | £156.09 | £106.14 | £102.96 |
| C211963 | H590mm | £156.09 | £106.14 | £102.96 |
| C211964 | H640mm | £156.09 | £106.14 | £102.96 |
| C211965 | H710mm | £156.09 | £106.14 | £102.96 |
| C211966 | H760mm | £156.09 | £106.14 | £102.96 |





600 x 600mm Square

| | | 1-2 | 3-14 | 15+ |
|---------|--------|---------|--------|--------|
| C211971 | H460mm | £105.42 | £71.68 | £69.54 |
| C211972 | H530mm | £105.42 | £71.68 | £69.54 |
| C211973 | H590mm | £105.42 | £71.68 | £69.54 |
| C211974 | H640mm | £105.42 | £71.68 | £69.54 |
| C211975 | H710mm | £105.42 | £71.68 | £69.54 |
| C211976 | H760mm | £105.42 | £71.68 | £69.54 |

1490 x 600mm Arc

| | | 1-2 | 3-14 | 15+ |
|---------|--------|---------|---------|---------|
| C212141 | H460mm | £278.78 | £189.57 | £183.88 |
| C212142 | H530mm | £278.78 | £189.57 | £183.88 |
| C212143 | H590mm | £278.78 | £189.57 | £183.88 |
| C212144 | H640mm | £278.78 | £189.57 | £183.88 |
| C212145 | H710mm | £278.78 | £189.57 | £183.88 |
| C212146 | H760mm | £278.78 | £189.57 | £183.88 |

* 2100mm when 4 together to make circular

1100mm Diameter Circular

| | | 1-2 | 3-14 | 15+ |
|---------|--------|---------|---------|---------|
| C211991 | H460mm | £280.86 | £190.99 | £185.25 |
| C211992 | H530mm | £280.86 | £190.99 | £185.25 |
| C211993 | H590mm | £280.86 | £190.99 | £185.25 |
| C211994 | H640mm | £280.86 | £190.99 | £185.25 |
| C211995 | H710mm | £280.86 | £190.99 | £185.25 |
| C211996 | H760mm | £280.86 | £190.99 | £185.25 |

1200mm Diameter Circular

| | | 1-2 | 3-14 | 15+ |
|---------|--------|---------|---------|---------|
| C212111 | H460mm | £346.97 | £235.94 | £228.87 |
| C212112 | H530mm | £346.97 | £235.94 | £228.87 |
| C212113 | H590mm | £346.97 | £235.94 | £228.87 |
| C212114 | H640mm | £346.97 | £235.94 | £228.87 |
| C212115 | H710mm | £346.97 | £235.94 | £228.87 |
| C212116 | H760mm | £346.97 | £235.94 | £228.87 |

1100 x 550mm Diameter Semi-Circular

| | | 1-2 | 3-14 | 15+ |
|---------|--------|---------|---------|---------|
| C212121 | H460mm | £151.76 | £103.20 | £100.10 |
| C212122 | H530mm | £151.76 | £103.20 | £100.10 |
| C212123 | H590mm | £151.76 | £103.20 | £100.10 |
| C212124 | H640mm | £151.76 | £103.20 | £100.10 |
| C212125 | H710mm | £151.76 | £103.20 | £100.10 |
| C212126 | H760mm | £151.76 | £103.20 | £100.10 |

1200 x 600mm Diameter Semi-Circular

| | | 1-2 | 3-14 | 15+ |
|---------|--------|---------|---------|---------|
| C212131 | H460mm | £164.60 | £111.93 | £108.57 |
| C212132 | H530mm | £164.60 | £111.93 | £108.57 |
| C212133 | H590mm | £164.60 | £111.93 | £108.57 |
| C212134 | H640mm | £164.60 | £111.93 | £108.57 |
| C212135 | H710mm | £164.60 | £111.93 | £108.57 |
| C212136 | H760mm | £164.60 | £111.93 | £108.57 |



CALL US ON 01527 878348



VISIT WWW.FORWARDPRODUCTS.CO.UK

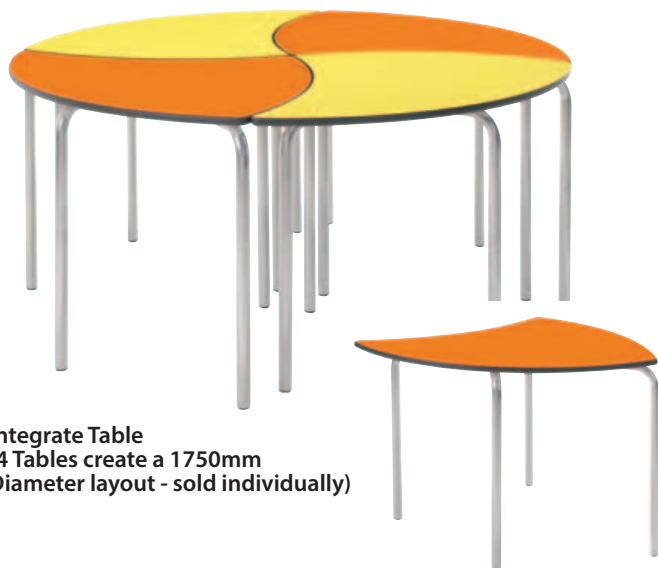

Integrate Table
(4 Tables create a 1750mm Diameter layout - sold individually)

Integrate Tables

- Truly unique shape offers endless creativity
- Size: 1220 x 875mm
- 5 year guarantee
- 25mm premium top with PU edge

| | | 1-2 | 3-14 | 15+ |
|---------|--------|---------|---------|---------|
| C212151 | H460mm | £223.42 | £116.18 | £112.70 |
| C212152 | H530mm | £223.42 | £116.18 | £112.70 |
| C212153 | H590mm | £223.42 | £116.18 | £112.70 |
| C212154 | H640mm | £223.42 | £116.18 | £112.70 |
| C212155 | H710mm | £223.42 | £116.18 | £112.70 |
| C212156 | H760mm | £223.42 | £116.18 | £112.70 |



Lateral Tables

- Extremely versatile with various shape combinations
- 3 together create a hexagonal shape of 1500mm diameter
- Size: 1400mm x 866mm diameter
- 10 year guarantee
- 25mm premium top with PU edge

| | | 1-2 | 3-14 | 15+ |
|---------|--------|---------|---------|---------|
| C212161 | H460mm | £225.53 | £117.28 | £113.76 |
| C212162 | H530mm | £225.53 | £117.28 | £113.76 |
| C212163 | H590mm | £225.53 | £117.28 | £113.76 |
| C212164 | H640mm | £225.53 | £117.28 | £113.76 |
| C212165 | H710mm | £225.53 | £117.28 | £113.76 |
| C212166 | H760mm | £225.53 | £117.28 | £113.76 |



Please Specify:

1. Top colour
2. Edge colour
3. Frame colour

Laminate Top Colours

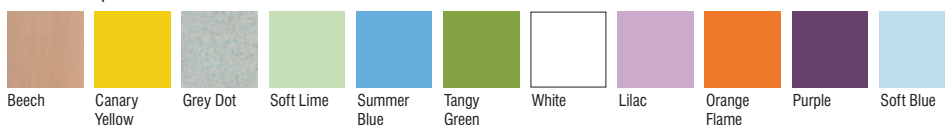

PU Edge Colours



Incredibly tough PU edging is moulded to the MDF core meaning it cannot be prised or picked away.

Frame Colours

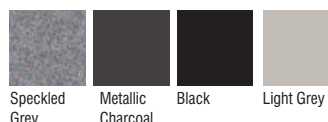

Please see Important Furniture Ordering Information on page 3 before placing your furniture order



Metric Tables

- Exciting new modular table designed to allow maximum flexibility
- Perfect for classrooms, libraries, ICT hot desks or breakout areas
- Size: 750 x 660mm (6 together form a 1635mm diameter circle)
- 5 year guarantee
- 18mm laminate top with PU edge
- Please specify top colour, edge colour and frame colour when ordering (see previous page for options)

| | | 1-2 | 3-14 | 15+ |
|---------|--------|---------|--------|--------|
| C212181 | H460mm | £126.33 | £80.54 | £78.12 |
| C212182 | H530mm | £126.33 | £80.54 | £78.12 |
| C212183 | H590mm | £126.33 | £80.54 | £78.12 |
| C212184 | H640mm | £126.33 | £80.54 | £78.12 |
| C212185 | H710mm | £126.33 | £80.54 | £78.12 |
| C212186 | H760mm | £126.33 | £80.54 | £78.12 |



All tables are available with drywipe table tops

Please see previous page for colour options

Please see Important Furniture Ordering Information on page 3 before placing your furniture order

Puzzle Tables

- Flexible and dynamic modular table with endless configuration possibilities
- Designed to seat 1 but can seat up to 3 when full working space is not essential
- Size: 940 x 890mm
- 5 year guarantee
- 18mm laminate top with PU edge
- Please specify top colour, edge colour and frame colour when ordering (see previous page for options)

| | | 1-2 | 3-14 | 15+ |
|---------|--------|---------|--------|--------|
| C212171 | H460mm | £151.69 | £96.71 | £93.80 |
| C212172 | H530mm | £151.69 | £96.71 | £93.80 |
| C212173 | H590mm | £151.69 | £96.71 | £93.80 |
| C212174 | H640mm | £151.69 | £96.71 | £93.80 |
| C212175 | H710mm | £151.69 | £96.71 | £93.80 |
| C212176 | H760mm | £151.69 | £96.71 | £93.80 |





Please Specify:

1. Top colour
2. Edge style & colour
3. Frame colour
4. Table height

Laminate Top Colours

| | | | | |
|-------|------|-------|------------|-------|
| | | | | |
| Ailsa | Blue | Beech | Light Grey | White |

Edge Styles

| | | |
|--|--|--|
| | | |
| MDF Edge Bullnosed, polished & lacquered | PU Edge High impact, resilient textured spray edge in Charcoal or Light Grey | Trespa Chamfered edge as standard. Chemical & heat resistant |

Craft Tables

- High quality comprehensive range of tables
- Perfect for art, food tech, science and craft environments
- Wide range of top, edge and frame finishes to complement any colour schemes
- Many heights available to suit all ages
- Please specify top colour, edge colour (if necessary), frame colour and table height when ordering
- **Please see Important Furniture Ordering Information on page 3 before placing your furniture order**

Trespa Top Colour

| | | | | |
|-------------------|----------------------|----------------------|----------------|-------|
| | | | | |
| Speckled Icy Blue | Speckled Pastel Grey | Speckled Powder Blue | Speckled White | White |

Frame Colours - Speckled Grey will be supplied if no colour is specified

| | | | | |
|---------------|-------------------|-------|------------|------------|
| | | | | |
| Speckled Grey | Metallic Charcoal | Black | Light Grey | Silver POA |

Fully Welded Craft Table

- Heavy duty fully welded H frame
- 25mm square steel tube
- 5 year guarantee
- Other heights available - please call for details

MDF Edge

| | W x D x H(mm) | 1-2 | 3-14 | 15+ |
|---------|------------------|---------|---------|---------|
| C212451 | 1200 x 600 x 850 | £158.72 | £116.77 | £107.70 |
| C212452 | 1200 x 750 x 850 | £184.64 | £135.84 | £125.29 |
| C212453 | 1500 x 750 x 850 | £275.33 | £202.57 | £186.83 |
| C215111 | 1200 x 600 x 900 | £158.72 | £116.77 | £107.70 |
| C215112 | 1200 x 750 x 900 | £184.64 | £135.84 | £125.29 |
| C215113 | 1500 x 750 x 900 | £275.33 | £202.57 | £186.83 |

PU Edge

| | W x D x H(mm) | 1-2 | 3-14 | 15+ |
|---------|------------------|---------|---------|---------|
| C212454 | 1200 x 600 x 850 | £178.16 | £131.07 | £120.89 |
| C212455 | 1200 x 750 x 850 | £204.08 | £150.14 | £138.48 |
| C212456 | 1500 x 750 x 850 | £261.69 | £207.34 | £191.23 |
| C215114 | 1200 x 600 x 900 | £178.16 | £131.07 | £120.89 |
| C215115 | 1200 x 750 x 900 | £204.08 | £150.14 | £138.48 |
| C215116 | 1500 x 750 x 900 | £261.69 | £207.34 | £191.23 |



Trespa

| | W x D x H(mm) | 1-2 | 3-14 | 15+ |
|---------|------------------|---------|---------|---------|
| C212457 | 1200 x 600 x 850 | £249.80 | £233.91 | £215.74 |
| C212458 | 1200 x 750 x 850 | £367.69 | £344.29 | £317.55 |
| C212459 | 1500 x 750 x 850 | £392.95 | £367.94 | £339.36 |
| C215117 | 1200 x 600 x 900 | £249.80 | £233.91 | £215.74 |
| C215118 | 1200 x 750 x 900 | £367.69 | £344.29 | £317.55 |
| C215119 | 1500 x 750 x 900 | £392.95 | £367.94 | £339.36 |

Crushbent Craft Table

- Chunky 28mm crushbent H frame
- 5 year guarantee
- Please specify height required - see details above

MDF Edge

| | W x D x H(mm) | 1-2 | 3-14 | 15+ |
|---------|------------------|---------|---------|---------|
| C212461 | 1200 x 600 x 850 | £158.72 | £116.77 | £107.70 |
| C212462 | 1200 x 750 x 850 | £184.64 | £135.84 | £125.29 |
| C212463 | 1500 x 750 x 850 | £275.33 | £202.57 | £186.83 |
| C215121 | 1200 x 600 x 900 | £158.72 | £116.77 | £107.70 |
| C215122 | 1200 x 750 x 900 | £184.64 | £135.84 | £125.29 |
| C215123 | 1500 x 750 x 900 | £275.33 | £202.57 | £186.83 |

PU Edge

| | W x D x H(mm) | 1-2 | 3-14 | 15+ |
|---------|------------------|---------|---------|---------|
| C212464 | 1200 x 600 x 850 | £178.16 | £131.07 | £120.89 |
| C212465 | 1200 x 750 x 850 | £204.08 | £150.14 | £138.48 |
| C212466 | 1500 x 750 x 850 | £261.69 | £207.34 | £191.23 |
| C215124 | 1200 x 600 x 900 | £178.16 | £131.07 | £120.89 |
| C215125 | 1200 x 750 x 900 | £204.08 | £150.14 | £138.48 |
| C215126 | 1500 x 750 x 900 | £261.69 | £207.34 | £191.23 |



Trespa

| | W x D x H(mm) | 1-2 | 3-14 | 15+ |
|---------|------------------|---------|---------|---------|
| C212467 | 1200 x 600 x 850 | £249.80 | £233.91 | £215.74 |
| C212468 | 1200 x 750 x 850 | £367.69 | £344.29 | £317.55 |
| C212469 | 1500 x 750 x 850 | £392.95 | £367.94 | £339.36 |
| C215127 | 1200 x 600 x 900 | £249.80 | £233.91 | £215.74 |
| C215128 | 1200 x 750 x 900 | £367.69 | £344.29 | £317.55 |
| C215129 | 1500 x 750 x 900 | £392.95 | £367.94 | £339.36 |



Craft Tables

Premium Craft Table

- Stylish 45mm round tube legs
- 10 year guarantee
- Please specify colours and height required - see details on previous page
- **Please see Important Furniture Ordering Information on page 3 before placing your furniture order**



MDF Edge

| | W x D x H(mm) | 1-2 | 3-14 | 15+ |
|---------|------------------|---------|---------|---------|
| C212471 | 1200 x 600 x 850 | £186.25 | £146.34 | £139.69 |
| C212472 | 1200 x 750 x 850 | £190.89 | £178.74 | £164.86 |
| C212473 | 1500 x 750 x 850 | £236.70 | £221.63 | £204.42 |
| C215131 | 1200 x 600 x 900 | £186.25 | £146.34 | £139.69 |
| C215132 | 1200 x 700 x 900 | £190.89 | £178.74 | £164.86 |
| C215133 | 1500 x 750 x 900 | £236.70 | £221.63 | £204.42 |

PU Edge

| | W x D x H(mm) | 1-2 | 3-14 | 15+ |
|---------|------------------|---------|---------|---------|
| C212474 | 1200 x 600 x 850 | £208.93 | £164.16 | £156.70 |
| C212475 | 1200 x 750 x 850 | £227.68 | £195.42 | £180.24 |
| C212476 | 1500 x 750 x 850 | £258.33 | £241.89 | £223.10 |
| C215134 | 1200 x 600 x 900 | £208.93 | £164.16 | £156.70 |
| C215135 | 1200 x 700 x 900 | £227.68 | £195.42 | £180.24 |
| C215136 | 1500 x 750 x 900 | £258.33 | £241.89 | £223.10 |

Trespa

| | W x D x H(mm) | 1-2 | 3-14 | 15+ |
|---------|------------------|---------|---------|---------|
| C212477 | 1200 x 600 x 850 | £384.83 | £302.37 | £288.62 |
| C212478 | 1200 x 750 x 850 | £458.22 | £429.07 | £395.74 |
| C212479 | 1500 x 750 x 850 | £490.19 | £459.00 | £423.35 |
| C215137 | 1200 x 600 x 900 | £384.83 | £302.37 | £288.62 |
| C215138 | 1200 x 700 x 900 | £458.22 | £429.07 | £395.74 |
| C215139 | 1500 x 750 x 900 | £490.19 | £459.00 | £423.35 |



Project Table

- Sturdy tables for all types of projects
- Grey laminated tops
- All 800mm high
- Frame colours: Red, Tangerine, Cyan, Blue, Lime, Apple Green and Grey - Please specify colour when ordering

| | | |
|---------|-----------------|---------|
| C212481 | W1220 x D1220mm | £406.54 |
| C212482 | W1820 x D1220mm | £488.32 |
| C212483 | W2420 x D1220mm | £563.08 |



Frame Colour Options



CALL US ON 01527 878348



VISIT WWW.FORWARDPRODUCTS.CO.UK



Premium Tilt Top Tables

- Designed and constructed to withstand the demands of the modern school environment
- Smooth no-slam action
- Superb strength and stability
- 18mm laminate top with spray PU edges
- Stylish silver frame
- 5 year guarantee
- 710mm high as standard



Rectangular

| | W x Dmm | 1-2 | 3-14 | 15+ |
|---------|------------|---------|---------|---------|
| C212341 | 1200 x 600 | £384.25 | £319.85 | £312.69 |
| C212343 | 1500 x 750 | £464.55 | £387.15 | £377.50 |
| C212344 | 1600 x 800 | £603.20 | £502.65 | £489.65 |
| C212346 | 1800 x 800 | £609.95 | £508.35 | £494.85 |

Circular

| | Diameter mm | 1-2 | 3-14 | 15+ |
|---------|-------------|---------|---------|---------|
| C212351 | 1100 | £460.85 | £384.00 | £375.25 |
| C212352 | 1200 | £473.60 | £394.75 | £384.50 |

Please Specify:

1. Top colour
2. Edge colour

Laminate Top Colours

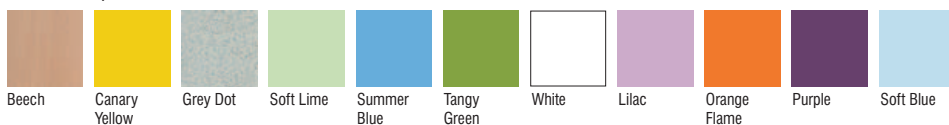

PU Edge Colours

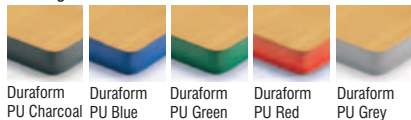

Frame Colour

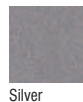

Height Adjustable Tables

- Durable steel frame and 18mm thick MDF edge laminated tops
- Adjustable between 512 - 805mm high
- Tamperproof fixings
- Side operated removable handle supplied as standard, top operated handle available on request

| | | |
|---------|----------------------------|---------|
| C212361 | Single Desk W750 x D600mm | £266.35 |
| C212362 | Double Desk W1200 x D600mm | £299.38 |



Please Specify:

Top colour

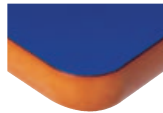

MDF Edge Information
The MDF core is bullnosed and lacquered creating a hardwearing finish that cannot be picked.

Laminate Top Colours



Portholes can be added on request at additional cost



Removable Handle - Top or Side Operated

Please see Important Furniture Ordering Information on page 3 before placing your furniture order

Premium Electric Height Adjustable Tables

- Heavy duty table with stylish enclosed leg design and 18mm thick premium laminated tops with spray PU edge
- Adjustable height motorised (electric powerpoint required)
- Adjustable between 700 - 1150mm high
- DDA compliant
- 5 year guarantee

| | | |
|---------|----------------|---------|
| C212371 | W1200 x D750mm | £948.66 |
| C212372 | W1500 x D750mm | £985.32 |



Please Specify:

1. Top colour
2. Edge colour

PU Edge Colours

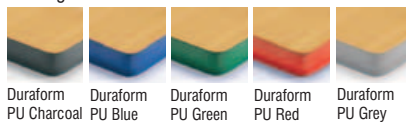

Duraform PU Charcoal Duraform PU Blue Duraform PU Green Duraform PU Red Duraform PU Grey

Laminate Top Colours

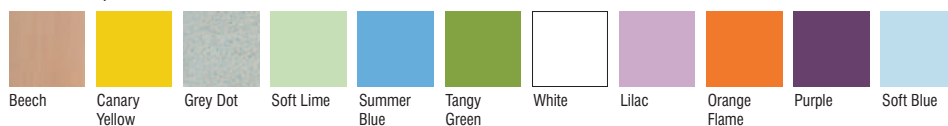

CALL US ON 01527 878348



VISIT WWW.FORWARDPRODUCTS.CO.UK

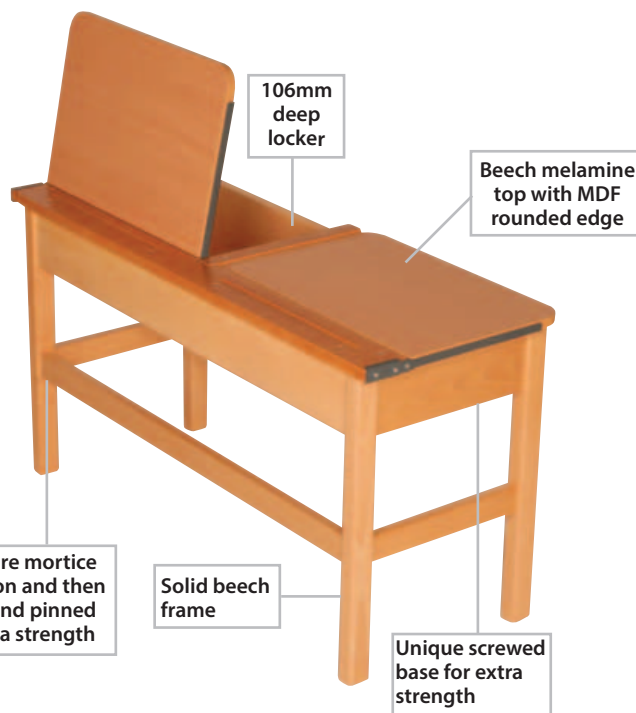

Straight Top Locker Desks

- These traditional desks are still popular throughout education and with good reason as they provide a sturdy, quality, long-lasting solution
- The desk frame is solid beech with mortice and tenon joints, glued and screwed for extra strength
- The desk lid is a beech melamine MDF top providing a matching finish
- The straight top locker desks have a pen groove on the back edge and are available as single or double desks
- The width between the legs is suitable for most chair types, internal width is shown below
- **Please see Important Furniture Ordering Information on page 3 before placing your furniture order**

Double Locker Desks

| | w x d x H(mm) | Internal width | |
|---------|------------------|----------------|---------|
| C212431 | 1100 x 456 x 600 | 1004mm | £206.98 |
| C212432 | 1100 x 456 x 650 | 1004mm | £206.98 |
| C212433 | 1100 x 456 x 700 | 1004mm | £206.98 |
| C212434 | 1100 x 456 x 750 | 1004mm | £206.98 |



Did you know?
Beech melamine MDF tops increase the lifespan by three times compared to solid beech tops

Coloured tops are also available to order. Please call for details

Single Locker Desks

| | w x d x H(mm) | Internal width | |
|---------|-----------------|----------------|---------|
| C212441 | 600 x 456 x 600 | 500mm | £141.10 |
| C212442 | 600 x 456 x 650 | 500mm | £141.10 |
| C212443 | 600 x 456 x 700 | 500mm | £141.10 |
| C212444 | 600 x 456 x 750 | 500mm | £141.10 |



Also available...
...sloping top and stepped locker desks. Please ask for details



Teacher's Pedestal Desks

Single Pedestal Desk

- This popular range of teacher's desks is available in a choice of wood finishes
- Drawers are mounted with metal runners and are fully lockable
- 3 drawer on right side supplied as standard, a 2 drawer pedestal including a filing drawer is also available at the same cost. Pedestals can be fitted on either side, please specify at time of order
- 10 year guarantee



| | | |
|---------|---------------------|---------|
| C212311 | 1200 x 745 x H725mm | £205.71 |
| C212312 | 1500 x 745 x H725mm | £242.80 |

Please specify melamine wood finish as shown below

Please Specify:

Wood Finish



Beech

Light Oak



Please see Important Furniture Ordering Information on page 3 before placing your furniture order

Please see further desking and pedestal options on pages 170-183

Double Pedestal Desk

- The double pedestal desk is a long-standing favourite with teachers, providing extra storage and a filing drawer
- Drawers are mounted with metal runners and are lockable
- 10 year guarantee



| | | |
|---------|---------------------|---------|
| C212321 | 1500 x 745 x H725mm | £305.45 |
|---------|---------------------|---------|

Please specify melamine wood finish as shown below

Please Specify:

Wood Finish



Beech

Light Oak





Exam Desks

- Popular range of tried and tested exam furniture
- Choice of standard or premium desks
- Option for beech or grey tops
- Versatile trolleys for easy transportation and storage
- Package deals give great savings
- Available for rapid delivery - please check when ordering
- **Please see Important Furniture Ordering Information on page 3 before placing your furniture order**

Standard Folding Desks

- 600 x 600 x H710mm
- Black frame
- Pen groove
- 15mm MDF edge tops
- Please order in multiples of 2

| | | 2 | 4-14 | 16+ |
|---------|----------------|--------|--------|--------|
| C212381 | Beech Top Desk | £31.64 | £21.51 | £20.87 |
| C212382 | Grey Top Desk | £33.80 | £22.98 | £22.30 |

Premium Folding Desks

- 600 x 600 x H710mm
- Black heavy gauge steel frame
- Pen groove
- 15mm MDF edge tops
- Please order in multiples of 2

| | | 2 | 4-14 | 16+ |
|---------|----------------|--------|--------|--------|
| C212391 | Beech Top Desk | £39.98 | £27.18 | £26.37 |

Trolleys

- Black heavy gauge steel frame
- Locking rubber castors
- Holds up to 25 or 40 desks

| | | |
|---------|----------------------------|---------|
| C212411 | 25 Desk Upright Trolley | £172.95 |
| C212412 | 40 Desk Horizontal Trolley | £194.36 |

Package Deals

| | | |
|---------|---|----------|
| C212421 | 25 Standard Beech Desks plus Upright Trolley | £613.15 |
| C212422 | 25 Standard Grey Desks plus Upright Trolley | £636.29 |
| C212423 | 24 Premium Beech Desks plus Upright Trolley | £671.00 |
| C212424 | 40 Standard Beech Desks plus Horizontal Trolley | £974.10 |
| C212425 | 40 Premium Beech Desks plus Horizontal Trolley | £1082.84 |



Study Carrels

StudyHub is designed to improve concentration by reducing visual and aural distractions. A flexible, cost effective solution for schools, libraries and IT suites, that are also ideal for commercial offices.

- 18mm top made from grade E1 melamine face high density particle board
- Height levelling feet are supplied as standard
- Supplied with one round, grey coloured cable port
- Pinnable fabric boards are available to purchase separately, in Black, Blue, Ruby or Grey fabric as standard
- Also available in Camira Cara, Carlow or Lucia ranges, please call for details
- Optional extra power port hole available including USB charging, data and media connections, please call for details
- CPU holders also available, please call for details



Study Booth Single

| | W x D x H(mm) | |
|---------|-------------------|---------|
| J214611 | 800 x 800 x 1230 | £238.61 |
| J214621 | 1000 x 800 x 1230 | £260.95 |

Study Booth Extension

| | W x D x H(mm) | |
|---------|------------------|---------|
| J214631 | 775 x 800 x 1230 | £208.78 |
| J214641 | 975 x 800 x 1230 | £231.13 |

Pinnable Fabric Board

| | W x D x H(mm) | |
|---------|---------------|--------|
| J214651 | 600 x 200 | £38.58 |
| J214661 | 800 x 200 | £40.92 |

Please Specify:

1. Top colour
2. Fabric colour

Colour Options



Fabric Options

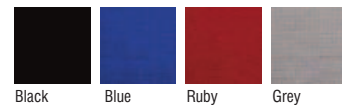

Budget Workstation

- Mobile trolley with lockable castors
- Two fixed shelves
- Supplied flat packed
- W675 x D660 x H725mm

| | | |
|---------|-------------|---------|
| J214821 | Workstation | £135.97 |
|---------|-------------|---------|



Please see Important Furniture Ordering Information on page 3 before placing your furniture order

Height Adjustable Workstation

- Heavy duty trolley adjustable between 540 - 790mm
- Durable rubber wheels, front 2 braked
- Supplied with four way power unit and lower shelf
- Delivered flat packed
- W1150 x D560 x H540-790mm

| | | |
|---------|-------------------|---------|
| J214831 | Height Adjustable | £298.16 |
|---------|-------------------|---------|



Please Specify:

1. Frame colour

Top

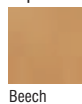

Frame Options





Study Carrels

Many other classroom table options available. Please call for details



Whiteboard Table



SmartTop Desk



Preparation Table



Woodworking Bench



3

Classroom Storage

| | |
|-----------------------|-------|
| Gratnells Trays | 52-53 |
| Premium Storage Range | 54-57 |
| Storage Systems | 58-65 |
| Bookcases | 66 |
| Cupboards | 67 |
| Coloured Edge Storage | 68-69 |
| Modular Storage | 70-71 |
| Art Storage | 72-73 |
| Maple Storage Range | 74-78 |
| Metal Storage | 79-80 |
| Lapcabby | 81 |



Trays

- Units come with Gratnells trays included



Castors

- Most units supplied with heavy duty lockable castors



Construction

- Hardwearing MFC units made from SFC and PEFC certified board



Standard Carcass Colours



Beech B

Maple M

Premium Carcass Colours



Japanese Ash

Birch

Light Oak

White

Red

Yellow

Blue

Green

Minimum quantities and additional costs apply to premium colours - please ask for details

Classroom Storage Range

Free Unwrap and Check Service

- Our experienced delivery drivers are trained to place units into position, unwrap them, remove the packaging and check for any damages
- Applies to ground floor deliveries, please call for details on first and second floor deliveries

Pre-Assembly Service

- Our units are delivered fully assembled saving you time

Rapid Delivery

- The typical lead time is just 10-15 working days; this can extend over the summer months, please call for details

Durability & Longevity

- All units are manufactured in the UK from high quality materials
- Save the environment choosing our storage units - our manufacturer recycles 100% of their paper, plastic and cardboard waste and burns wood waste to heat the factory

Carcass Colours

- Beech or Maple carcasses are supplied as standard
- Premium colours available - please call for pricing



Gratnells Storage Trays

Gratnells trays are supplied free with the storage units on the following pages. Simply specify your preferred choice of tray sizes and colours when ordering.

Colour Chart

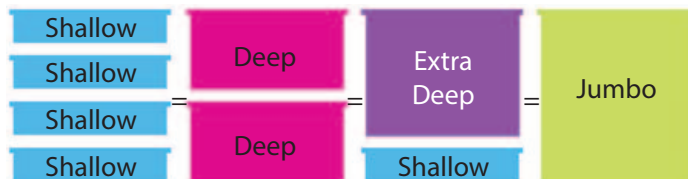



Premium Range Tray Units

- High quality UK manufactured range
- Provides a sleek fitted furniture look from individual pieces
- Grattells trays supplied free of charge with these units – see page 53 for colour options
- Contemporary white or light grey carcasses
- Available with or without lockable castors and doors
- **Please see Important Furniture Ordering Information on page 3 before placing your furniture order**
- When ordering please specify:
 1. Carcass colour - Grey or White
 2. Tray colour – see page 53 for colour options

Premium 6 Shallow Tray Unit

- W363 x D475 x H617mm

| | | |
|---------|----------------------|---------|
| C213100 | With Castors No Door | £114.81 |
| C213101 | Static No Door | £114.81 |
| C213102 | With Castors & Door | £137.78 |
| C213103 | Static With Door | £137.78 |

* Please specify carcass colour and tray colours

Premium 8 Shallow Tray Unit

- W363 x D475 x H789mm

| | | |
|---------|----------------------|---------|
| C213104 | With Castors No Door | £122.47 |
| C213105 | Static No Door | £122.47 |
| C213106 | With Castors & Door | £145.44 |
| C213107 | Static With Door | £145.44 |

* Please specify carcass colour and tray colours



Premium Range Tray Units

- High quality UK manufactured range
- Provides a sleek fitted furniture look from individual pieces
- Gratnells trays supplied free of charge with these units – see page 53 for colour options
- Contemporary white or light grey carcasses
- Available with or without lockable castors and doors
- **Please see Important Furniture Ordering Information on page 3 before placing your furniture order**
- When ordering please specify:
 1. Carcass colour - Grey or White
 2. Tray colour – see page 53 for colour options



Gratnells trays supplied free of charge with all units - see page 53 for colours

Premium 12 Shallow Tray Unit

- W704 x D475 x H617mm

| | | |
|---------|-----------------------|---------|
| C213108 | With Castors No Doors | £168.39 |
| C213109 | Static No Doors | £168.39 |
| C213110 | With Castors & Doors | £199.01 |
| C213111 | Static With Doors | £199.01 |

* Please specify carcass colour and tray colours



Premium 16 Shallow Tray Unit

- W704 x D475 x H789mm

| | | |
|---------|-----------------------|---------|
| C213112 | With Castors No Doors | £183.70 |
| C213113 | Static No Doors | £183.70 |
| C213114 | With Castors & Doors | £214.32 |
| C213115 | Static With Doors | £214.32 |

* Please specify carcass colour and tray colours



Premium 18 Shallow Tray Unit

- W1045 x D475 x H617mm

| | | |
|---------|-----------------------|---------|
| C213116 | With Castors No Doors | £229.62 |
| C213117 | Static No Doors | £229.62 |
| C213118 | With Castors & Doors | £267.90 |
| C213119 | Static With Doors | £267.90 |

* Please specify carcass colour and tray colours



Premium 24 Shallow Tray Unit

- W1045 x D475 x H789mm

| | | |
|---------|-----------------------|---------|
| C213120 | With Castors No Doors | £267.90 |
| C213125 | Static No Doors | £267.90 |
| C213126 | With Castors & Doors | £313.82 |
| C213127 | Static With Doors | £313.82 |

* Please specify carcass colour and tray colours

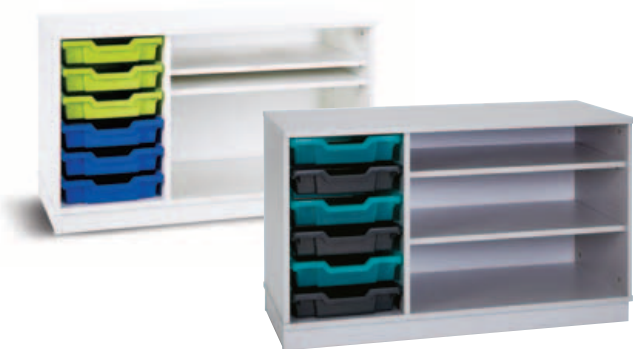

Gratnells trays supplied free of charge with tray units - see page 53 for colours



Premium Range

- High quality UK manufactured range
- Provides a sleek fitted furniture look from individual pieces
- Gratnells trays supplied free of charge with these units – see page 53 for colour options
- Contemporary white or light grey carcasses
- Available with or without lockable castors and doors
- **Please see Important Furniture Ordering Information on page 3 before placing your furniture order**
- When ordering please specify:
 1. Carcass colour - Grey or White
 2. Tray colour – see page 53 for colour options

Premium 6 Shallow Tray Unit

2 Adjustable Shelves

- W1045 x D475 x H617mm

| | | |
|---------|-----------------------|---------|
| C213128 | With Castors No Doors | £214.32 |
| C213129 | Static No Doors | £214.32 |
| C213130 | With Castors & Doors | £252.59 |
| C213135 | Static With Doors | £252.59 |

* Please specify carcass colour and tray colours

Premium 8 Shallow Tray Unit

2 Adjustable Shelves

- W1045 x D475 x H789mm

| | | |
|---------|-----------------------|---------|
| C213136 | With Castors No Doors | £244.93 |
| C213137 | Static No Doors | £244.93 |
| C213138 | With Castors & Doors | £290.86 |
| C213139 | Static With Doors | £290.86 |

* Please specify carcass colour and tray colours

Premium Storage Bookcase

2 Adjustable Shelves

- W1045 x D475 x H617mm

| | | |
|---------|-----------------------|---------|
| C213140 | With Castors No Doors | £199.01 |
| C213145 | Static No Doors | £199.01 |

2 Adjustable Shelves

- W1045 x D475 x H789mm

| | | |
|---------|-----------------------|---------|
| C213148 | With Castors No Doors | £221.97 |
| C213149 | Static No Doors | £221.97 |

1 Fixed Shelf & 4 Adjustable Shelves

- W1045 x D475 x H1818mm

| | | |
|---------|--------|---------|
| C213155 | Static | £260.25 |
|---------|--------|---------|

* Please specify carcass colour





Premium Range

- Same quality range as Premium Range tray units
- Adjustable shelves and lockable doors
- Combination unit comes with Gratnells trays – see page 53 for tray colour options
- Contemporary white or light grey carcasses
- Lower cupboards available with or without lockable castors
- **Please see Important Furniture Ordering Information on page 3 before placing your furniture order**
- When ordering please specify:
 1. Carcass colour - Grey or White
 2. Tray colour – see page 53 for colour options



Premium Cupboard

2 Adjustable Shelves

- W1045 x D475 x H617mm

| | | |
|---------|----------------------|---------|
| C213146 | With Castors & Doors | £229.62 |
| C213147 | Static with Doors | £229.62 |

2 Adjustable Shelves

- W1045 x D475 x H789mm

| | | |
|---------|----------------------|---------|
| C213150 | With Castors & Doors | £252.59 |
| C213153 | Static with Doors | £252.59 |

1 Fixed Shelf & 4 Adjustable Shelves

- W1045 x D475 x H1818mm

| | | |
|---------|--------|---------|
| C213156 | Static | £306.17 |
|---------|--------|---------|

* Please specify carcass colour

Premium 21 Shallow Tray Storage Cupboard

2 Adjustable Shelves

- W1045 x D475 x H1818mm

| | | |
|---------|--------|---------|
| C213154 | Static | £535.79 |
|---------|--------|---------|

* Please specify carcass colour and tray colours





Gratnells trays supplied free of charge with all units - see page 53 for colours



Best Selling Storage Units

- Great quality tray units
- Manufactured in the UK
- Gratnells trays supplied free of charge with all units - see page 53 for colour options
- Please call for prices on premium colours
- **Please see Important Furniture Ordering Information on page 3 before placing your furniture order**

6 Tray Unit

- W360 x D453 x H617mm

| | | |
|----------|-------------------------|---------|
| C213191* | 6 Tray Unit - No Door | £91.25 |
| C213192* | 6 Tray Unit - With Door | £137.05 |

* Please specify carcass colour and tray colours

12 Tray Unit

- W700 x D453 x H617mm

| | | |
|----------|---------------------------|---------|
| C213211* | 12 Tray Unit - No Doors | £135.84 |
| C213212* | 12 Tray Unit - With Doors | £222.00 |

* Please specify carcass colour and tray colours

18 Tray Unit

- W1030 x D453 x H635mm

| | | |
|----------|---------------------------|---------|
| C213221* | 18 Tray Unit - No Doors | £153.74 |
| C213222* | 18 Tray Unit - With Doors | £234.33 |

* Please specify carcass colour and tray colours

Please Specify:

1. Standard Carcass Colours - Beech or Maple
2. Tray colour required - see page 53 for colour options

Standard Carcass Colours



Beech *B Maple *M

Premium Carcass Colours



Lissa Oak Red Blue Green Yellow Light Grey White

Minimum quantities and additional costs apply to premium colours - please ask for details



Best Selling Storage Units

- When ordering please specify:
 1. Tray colour required - see page 53 for colour options
 2. Carcass colour; Beech supplied as standard, please see previous page for carcass colour options
- **Please see Important Furniture Ordering Information on page 3 before placing your furniture order**

24 Tray Unit

- W1030 x D453 x H789mm

| | | |
|----------|---------------------------|---------|
| C213231* | 24 Tray Unit - No Doors | £206.99 |
| C213232* | 24 Tray Unit - With Doors | £271.34 |

* Please specify carcass colour and tray colours



Gratnells trays
supplied free of
charge with all units
- see page 53 for
colours

30 Tray Unit

- W1030 x D453 x H961mm

| | | |
|----------|---------------------------|---------|
| C213241* | 30 Tray Unit - No Doors | £285.78 |
| C213242* | 30 Tray Unit - With Doors | £352.70 |

* Please specify carcass colour and tray colours



Other Units (not shown)

| | | |
|----------|---|---------|
| C213251* | 8 Tray Unit (Single Column) W360 x D453 x H789mm | £130.82 |
| C213252* | 16 Tray Unit (Double Column) W700 x D453 x H789mm | £185.00 |
| C213253* | 21 Tray Unit (Triple Column) W1030 x D453 x H703mm | £214.17 |

* Please specify carcass colour and tray colours

Tray & Shelving Units

| | | |
|----------|--|---------|
| C213261* | 6 Tray Wide Unit & 2 Adjustable Shelves W1030 x D453 x H617mm | £185.00 |
| C213262* | 8 Tray Wide Unit & 2 Adjustable Shelves W1030 x D453 x H789mm | £197.34 |

* Please specify carcass colour and tray colours





Four Column Tray Units

- Great quality tray units
- Manufactured in the UK
- Gratnells trays supplied free of charge with all units - see page 53 for colour options
- **Please see Important Furniture Ordering Information on page 3 before placing your furniture order**
- When ordering please specify:
 1. Tray colour required - see page 53 for colour options
 2. Carcass colour please see following page for colour details



24 Shallow Tray Unit

- W1358 x D462 x H617mm

| | | |
|----------|---------------------------|---------|
| C213271* | 24 Tray Unit - No Doors | £298.46 |
| C213272* | 24 Tray Unit - With Doors | £354.38 |

* Please specify carcass colour and tray colours



28 Shallow Tray Unit

- W1358 x D462 x H703mm

| | | |
|----------|---------------------------|---------|
| C213281* | 28 Tray Unit - No Doors | £326.18 |
| C213282* | 28 Tray Unit - With Doors | £382.52 |

* Please specify carcass colour and tray colours



32 Shallow Tray Unit

- W1358 x D462 x H789mm

| | | |
|----------|---------------------------|---------|
| C213291* | 32 Tray Unit - No Doors | £349.40 |
| C213292* | 32 Tray Unit - With Doors | £415.81 |

* Please specify carcass colour and tray colours

Other Units (not shown)

| | | |
|----------|---|---------|
| C213311* | 20 Shallow Tray Unit - No Doors W1358 x D462 x H531mm | £273.49 |
| C213312* | 40 Shallow Tray Unit - No Doors W1358 x D462 x H961mm | £425.38 |
| C213313* | 48 Shallow Tray Unit - No Doors W1358 x D462 x H1133mm | £482.87 |
| C213314* | 64 Shallow Tray Unit - No Doors W1358 x D462 x H1477mm | £594.95 |

* Please specify carcass colour and tray colours



Tray Storage Cupboards

- Huge storage capacity in this popular range of tall storage units
- **Please see Important Furniture Ordering Information on page 3 before placing your furniture order**



21 Tray Unit with Doors

- Tray storage for 21 trays and 3 additional shelves
- Full height lockable doors
- W1030 x D477 x H1810mm

C213321* 21 Tray Cupboard - Full Doors £457.41

* Please specify carcass colour and tray colours



24 Tray Unit

- Tray storage for 24 trays and 2 additional shelves
- Half height or full height doors available
- W1030 x D485 x H1468mm

C213331* 24 Tray Cupboard - Half Doors £394.55

C213332* 24 Tray Cupboard - Full Doors £457.41

* Please specify carcass colour and tray colours

60 Tray Unit

- Available with or without doors
- W1030 x D477 x H1810mm

C213341* 60 Tray Cupboard - No Doors £504.72

C213342* 60 Tray Cupboard - Full Doors £581.95

* Please specify carcass colour and tray colours



Please Specify:

1. Standard Carcass Colours - Beech or Maple
2. Tray colour required - see page 53 for colour options

Standard Carcass Colours



Beech *B Maple *M

Premium Carcass Colours



Lissa Oak Red Blue Green Yellow Light Grey White

Minimum quantities and additional costs apply to premium colours - please ask for details

Gratnells trays supplied free of charge with all units - see page 53 for colours



CALL US ON 01527 878348



VISIT WWW.FORWARDPRODUCTS.CO.UK



Jumbo Storage Units

- These units are extremely popular, offering organised storage capacity for large, messy and heavy items
- Gratnells trays supplied free of charge with all units, see page 53 for colour options
- **Please see Important Furniture Ordering Information on page 3 before placing your furniture order**
- When ordering please specify:
 1. Tray colour required - see page 53 for colour options
 2. Carcass colour please see following page for colour details

12 Jumbo Tray Unit

- W1358 x D453 x H1067mm

| | | |
|----------|---------------------------|---------|
| C213351* | 12 Tray Unit - No Doors | £325.29 |
| C213352* | 12 Tray Unit - With Doors | £380.61 |

* Please specify carcass colour and tray colours

9 Jumbo Tray Unit

- W1030 x D453 x H1067mm

| | | |
|----------|--------------------------|---------|
| C213361* | 9 Tray Unit - No Doors | £353.67 |
| C213362* | 9 Tray Unit - With Doors | £409.64 |

* Please specify carcass colour and tray colours

6 Jumbo Tray Unit

| | | |
|----------|-------------------------------|---------|
| C213371* | 6 Tall Tray Unit -No Doors | |
| | W700 x D453 x H1067mm | £254.33 |
| C213372* | 6 Tall Tray Unit -With Doors | |
| | W700 x D453 x H1067mm | £310.73 |
| C213373* | 6 Wide Tray Unit - No Doors | |
| | W1030 x D453 x H739mm | £347.26 |
| C213374* | 6 Wide Tray Unit - With Doors | |
| | W1030 x D453 x H739mm | £402.76 |

* Please specify carcass colour and tray colours

8 Jumbo Tray Unit

- W1358 x D453 x H739mm

| | | |
|----------|--------------------------|---------|
| C213381* | 8 Tray Unit - No Doors | £278.82 |
| C213382* | 8 Tray Unit - With Doors | £334.08 |

* Please specify carcass colour and tray colours

4 Jumbo Tray Unit

- W700 x D453 x H810mm

| | | |
|----------|--------------------------|---------|
| C213391* | 4 Tray Unit - No Doors | £244.22 |
| C213392* | 4 Tray Unit - With Doors | £290.37 |

* Please specify carcass colour and tray colours



Combination Storage Units

- Great storage possibilities with these variety units
- **Please see Important Furniture Ordering Information on page 3 before placing your furniture order**

Gratnells trays
supplied free of
charge with all units
- see page 53 for
colours



24 Shallow or 12 Deep Tray Unit

- The combination unit allows a mixture of shallow and deep trays
- W1358 x D453 x H707mm

| | | |
|----------|------------------------------|---------|
| C213411* | 24/12 Tray Unit - No Doors | £314.74 |
| C213412* | 24/12 Tray Unit - With Doors | £367.01 |

* Please specify carcass colour and tray colours



32 Shallow or 16 Deep Tray Unit

- The combination unit allows a mixture of shallow and deep trays
- W1358 x D453 x H835mm

| | | |
|----------|------------------------------|---------|
| C213421* | 32/16 Tray Unit - No Doors | £394.55 |
| C213422* | 32/16 Tray Unit - With Doors | £454.85 |

* Please specify carcass colour and tray colours



36 Shallow or 18 Deep Tray Unit

- This popular storage unit has a large capacity with 36 shallow or 18 deep trays, or a combination of both
- W1030 x D453 x H1210mm

| | | |
|----------|------------------------------|---------|
| C213431* | 36/18 Tray Unit - No Doors | £414.91 |
| C213432* | 36/18 Tray Unit - With Doors | £485.86 |

* Please specify carcass colour and tray colours

Please Specify:

1. Standard Carcass Colours - Beech or Maple
2. Tray colour required - see page 53 for colour options

Standard Carcass
Colours



Beech *B Maple *M

Premium Carcass
Colours



Lissa Oak Red Blue Green Yellow Light Grey White

Minimum quantities and additional costs apply to premium colours - please ask for details



CALL US ON 01527 878348



VISIT WWW.FORWARDPRODUCTS.CO.UK



Extra Deep Storage Units

- Huge capacity with these popular extra deep tray units
- Gratnells trays supplied free of charge with all units, see page 53 for colour options
- **Please see Important Furniture Ordering Information on page 3 before placing your furniture order**

6 Extra Deep Tray Unit

- W700 x D453 x H857mm

| | | |
|----------|--------------------------|---------|
| C213441* | 6 Tray Unit - No Doors | £208.77 |
| C213442* | 6 Tray Unit - With Doors | £264.63 |

* Please specify carcass colour and tray colours



12 Extra Deep Tray Unit

- W1358 x D453 x H857mm

| | | |
|----------|---------------------------|---------|
| C213451* | 12 Tray Unit - No Doors | £353.85 |
| C213452* | 12 Tray Unit - With Doors | £411.91 |

* Please specify carcass colour and tray colours



16 Extra Deep Tray Unit

- W1358 x D453 x H1115mm

| | | |
|----------|---------------------------|---------|
| C213461* | 16 Tray Unit - No Doors | £441.25 |
| C213462* | 16 Tray Unit - With Doors | £490.89 |

* Please specify carcass colour and tray colours

Gratnells trays
supplied free of
charge with all units
- see page 53 for
colours

Please Specify:

1. Standard Carcass Colours - Beech or Maple
2. Tray colour required - see page 53 for colour options

Standard Carcass Colours



Beech *B Maple *M

Premium Carcass Colours



Lissa Oak Red Blue Green Yellow Light Grey White

Minimum quantities and additional costs apply to premium colours - please ask for details





Open & Sliding Door Tray Units

- Combination units with or without lockable sliding doors
- **Please see Important Furniture Ordering Information on page 3 before placing your furniture order**
- When ordering please specify:
 1. Tray colour required - see page 53 for colour options
 2. Carcass: please see previous page for colour details

16 Shallow, 4 Deep and 3 Extra Deep Tray Unit

| | | | |
|----------|-----------------------------------|-----------------------|---------|
| C213471* | 23 Tray Unit - No Doors | W1358 x D453 x H842mm | £382.76 |
| C213472* | 23 Tray Unit - With Sliding Doors | W1358 x D510 x H842mm | £450.06 |

* Please specify carcass colour and tray colours



8 Deep and 6 Extra Deep Tray Unit

| | | | |
|----------|-----------------------------------|-----------------------|---------|
| C213481* | 14 Tray Unit - No Doors | W1358 x D453 x H842mm | £376.78 |
| C213482* | 14 Tray Unit - With Sliding Doors | W1358 x D510 x H842mm | £447.54 |

* Please specify carcass colour and tray colours



16 Shallow and 6 Extra Deep Tray Unit

| | | | |
|----------|-----------------------------------|-----------------------|---------|
| C213491* | 22 Tray Unit - No Doors | W1358 x D453 x H842mm | £354.38 |
| C213492* | 22 Tray Unit - With Sliding Doors | W1358 x D510 x H842mm | £438.08 |

* Please specify carcass colour and tray colours





Open Bookcases

- This popular range of open bookcases has been specifically designed for classroom environments
- See below for colour options
- **Please see Important Furniture Ordering Information on page 3 before placing your furniture order**

A Bookcase 750

- 2 adjustable shelves
- W900 x D320 x H750mm

C213511* Bookcase 750mm £148.35

* Please specify carcass colour

B Bookcase 1000

- 2 adjustable shelves
- W900 x D320 x H1000mm

C213521* Bookcase 1000mm £162.84

* Please specify carcass colour

C Bookcase 1250

- 1 fixed and 2 adjustable shelves
- W900 x D320 x H1250mm

C213531* Bookcase 1250mm £177.14

* Please specify carcass colour

D Bookcase 1500

- 1 fixed and 2 adjustable shelves
- W900 x D320 x H1500mm

C213541* Bookcase 1500mm £208.22

* Please specify carcass colour

E Bookcase 1800

- 1 fixed and 4 adjustable shelves
- W900 x D320 x H1800mm

C213551* Bookcase 1800mm £232.13

* Please specify carcass colour

Please Specify:

1. Standard Carcass Colours - Beech or Maple

Standard Carcass Colours



Beech *B Maple *M

Premium Carcass Colours



Lissa Oak Red Blue Green Yellow Light Grey White

Minimum quantities and additional costs apply to premium colours - please ask for details



Lockable Storage Cupboards

A Cupboard 750

- 2 adjustable shelves
- W1030 x D477 x H768mm

C213561* Cupboard 768mm £232.53

* Please specify carcass colour

B Cupboard 1000

- 2 adjustable shelves
- W1030 x D477 x H1018mm

C213571* Cupboard 1018mm £256.55

* Please specify carcass colour

C Cupboard 1250

- 1 fixed and 2 adjustable shelves
- W1030 x D477 x H1268mm

C213581* Cupboard 1268mm £284.78

* Please specify carcass colour

D Cupboard 1500

- 1 fixed and 2 adjustable shelves
- 1030 x D477 x H1518mm

C213591* Cupboard 1518mm £305.28

* Please specify carcass colour

E Cupboard 1800

- 1 fixed and 4 adjustable shelves
- W1030 x D477 x H1818mm

C213611* Cupboard 1818mm £332.19

* Please specify carcass colour



Please see Important Furniture Ordering Information on page 3 before placing your furniture order

Please Specify:

1. Standard Carcass Colours - Beech or Maple

Standard Carcass Colours



Beech *B Maple *M

Premium Carcass Colours



Lissa Oak Red Blue Green Yellow Light Grey White

Minimum quantities and additional costs apply to premium colours - please ask for details



CALL US ON 01527 878348



VISIT WWW.FORWARDPRODUCTS.CO.UK



Coloured Edge Storage Units

- Add some colour to the classroom with this bright innovative range
- Beech carcass supplied as standard, please see below for premium colour options
- Gratnells trays supplied free of charge with all units, see page 53 for colour options
- **Please see Important Furniture Ordering Information on page 3 before placing your furniture order**

Gratnells trays supplied free of charge with all units - see page 53 for colours

12 Jumbo Tray Unit

- W1358 x D453 x H1067mm

| | | |
|---------|--------------------------------|---------|
| C213831 | 12 Tray Unit - With Red Edge | £378.39 |
| C213832 | 12 Tray Unit - With Blue Edge | £378.39 |
| C213833 | 12 Tray Unit - With Green Edge | £378.39 |

8 Jumbo Tray Unit

- W1358 x D453 x H739mm

| | | |
|---------|-------------------------------|---------|
| C213841 | 8 Tray Unit - With Red Edge | £287.32 |
| C213842 | 8 Tray Unit - With Blue Edge | £287.32 |
| C213843 | 8 Tray Unit - With Green Edge | £287.32 |

24 Shallow Tray Unit

- W1030 x D453 x H789mm

| | | |
|---------|--------------------------------|---------|
| C213851 | 24 Tray Unit - With Red Edge | £234.69 |
| C213852 | 24 Tray Unit - With Blue Edge | £234.69 |
| C213853 | 24 Tray Unit - With Green Edge | £234.69 |

18 Shallow Tray Unit

- W1030 x D453 x H617mm

| | | |
|---------|--------------------------------|---------|
| C213861 | 18 Tray Unit - With Red Edge | £220.32 |
| C213862 | 18 Tray Unit - With Blue Edge | £220.32 |
| C213863 | 18 Tray Unit - With Green Edge | £220.32 |

Please Specify:

1. Standard Carcass Colour
2. Tray colour required - see page 53 for colour options

Standard Carcass Colour



Beech

Premium Carcass Colours



Lissa Oak



Red



Blue



Green



Yellow



Light Grey



White

*Minimum quantities and additional costs apply to premium colours - please ask for details



Coloured Edge Bookcases & Cupboards

- Durable bookcases and cupboards with brightly coloured edges
- 18mm carcass with heavy duty 25mm shelves
- When ordering please specify:
 - Carcass colour; Beech supplied as standard, please see previous page for premium colour options
- **Please see Important Furniture Ordering Information on page 3 before placing your furniture order**



Low Storage Unit

- 2 adjustable shelves
- Cupboards with doors W1030 x D477 x H768mm
- Open bookcases W900 x D320 x H750mm

| | | |
|---------|-----------------------|---------|
| C213871 | Cupboard - Red Edge | £237.69 |
| C213872 | Cupboard - Blue Edge | £237.69 |
| C213873 | Cupboard - Green Edge | £237.69 |

| | | |
|---------|-----------------------|---------|
| C213874 | Bookcase - Red Edge | £150.16 |
| C213875 | Bookcase - Blue Edge | £150.16 |
| C213876 | Bookcase - Green Edge | £150.16 |



Medium Storage Unit

- 1 fixed and 2 adjustable shelves
- Cupboards with doors W1030 x D477 x H1268mm
- Open bookcases W900 x D320 x H1250mm

| | | |
|---------|-----------------------|---------|
| C213881 | Cupboard - Red Edge | £280.80 |
| C213882 | Cupboard - Blue Edge | £280.80 |
| C213883 | Cupboard - Green Edge | £280.80 |

| | | |
|---------|-----------------------|---------|
| C213884 | Bookcase - Red Edge | £159.20 |
| C213885 | Bookcase - Blue Edge | £159.20 |
| C213886 | Bookcase - Green Edge | £159.20 |



High Storage Unit

- 1 fixed and 4 adjustable shelves
- Cupboards with doors W1030 x D477 x H1818mm
- Open bookcases W900 x D320 x H1800mm

| | | |
|---------|-----------------------|---------|
| C213891 | Cupboard - Red Edge | £337.67 |
| C213892 | Cupboard - Blue Edge | £337.67 |
| C213893 | Cupboard - Green Edge | £337.67 |

| | | |
|---------|-----------------------|---------|
| C213894 | Bookcase - Red Edge | £182.61 |
| C213895 | Bookcase - Blue Edge | £182.61 |
| C213896 | Bookcase - Green Edge | £182.61 |





Perfect for stacking in primary and early years areas

Please Specify:

- 1. Standard Carcass Colours - Beech or Maple
- 2. Tray colour required - see page 53 for colour options

Standard Carcass Colours

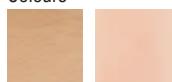

Beech *B Maple *M

Premium Carcass Colours



Lissa Oak Red Blue Green Yellow Light Grey White

Minimum quantities and additional costs apply to premium colours - please ask for details

Modular Storage Range

- These storage units are a versatile stackable storage solution that can be customised to suit every classroom
- Each unit comes complete with castors and locating pins which are used when stacking
- All units can be stacked with each other to make a whole range of different storage combinations
- Gratnells trays supplied free of charge with all units, see page 53 for colour options
- **Please see Important Furniture Ordering Information on page 3 before placing your furniture order**

Modular 24 Shallow Tray Unit

- W1030 x D450 x H745mm

C214121* 24 Shallow Tray Unit £238.23

* Please specify carcass colour and tray colours

Modular 12 Deep Tray Unit

- W1030 x D450 x H745mm

C214131* 12 Deep Tray Unit £248.88

* Please specify carcass colour and tray colours

Modular 6 Jumbo Tray Unit

- W1030 x D450 x H745mm

C214141* 6 Jumbo Tray Unit £243.68

* Please specify carcass colour and tray colours

Modular Storage Range

- Assortment of tray units and bookcase units
- When ordering please specify:
 1. Tray colour required - see page 53 for colour options
 2. Carcass colour: please see previous page for colour options
- **Please see Important Furniture Ordering Information on page 3 before placing your furniture order**



Modular 16 Shallow Tray Unit

- W692 x D450 x H745mm

C214151* 16 Shallow Tray Unit £236.49

* Please specify carcass colour and tray colours

Modular 8 Deep Tray Unit

- W692 x D450 x H745mm

C214161* 8 Deep Tray Unit £236.49

* Please specify carcass colour and tray colours



Gratnells trays supplied free of charge with all units - see page 53 for colours

Modular 4 Jumbo Tray Unit

- W692 x D450 x H745mm

C214171* 4 Jumbo Tray Unit £236.49

* Please specify carcass colour and tray colours

Modular Unit with 1 Shelf

- W692 x D450 x H745mm

C214181* Unit with 1 Shelf £209.74

* Please specify carcass colour



Modular Unit with 4 Compartments

- W692 x D450 x H745mm

C214191* Unit with 4 Compartments £209.74

* Please specify carcass colour



Examples of stacking configurations



Please Specify:

1. Standard Carcass Colours - Beech or Maple

Standard Carcass Colours



Beech *B Maple *M

Premium Carcass Colours



Lissa Oak Red Blue Green Yellow Light Grey White

Minimum quantities and additional costs apply to premium colours - please ask for details

Art Storage Units

- Heavy duty units holding paper up to A1
- Huge storage potential, especially in the plan chests
- Bespoke and built-in plan chests also available, please call for details
- **Please see Important Furniture Ordering Information on page 3 before placing your furniture order**

Static Plan Chest

- 6 drawers with drawer stops
- Stylish silver D handles
- See below for colour options
- W1015 x D750 x H780mm

| | | |
|---------|-------------------------------|---------|
| C214451 | Static Plan Chest | £454.96 |
| C214452 | Plan Chest - Coloured Drawers | £461.01 |

* Please specify carcass colour

Mobile Paper Storage Unit

- 4 open fronted sliding drawers
- See below for colour options
- W1015 x D750 x H780mm

| | | |
|---------|---------------------|---------|
| C214461 | Mobile Storage Unit | £359.17 |
|---------|---------------------|---------|

* Please specify carcass colour

Mobile Paper Storage Unit with Doors

- 4 sliding drawers with lockable doors
- See below for colour options
- W1015 x D770 x H780mm

| | | |
|---------|--------------------------------|---------|
| C214471 | Mobile Storage Unit With Doors | £394.55 |
|---------|--------------------------------|---------|

* Please specify carcass colour



Art Storage Units

- Wide variety of additional units perfect for the storage of art materials
- Kinderbox units have deep, open top display compartments
- **Please see Important Furniture Ordering Information on page 3 before placing your furniture order**



16 Tray A3 Paper Storage Unit

- Trays available in Red, Yellow, Blue and Green
- W970 x D493 x H789mm

C214481* 16 Tray Storage Unit £305.28

* Please specify carcass colour and tray colours



Triple Combination Unit

- 12 shallow or 6 deep trays and 1 shelf
- W1030 x D453 x H789mm

C214491* Triple Combination Unit £256.55

* Please specify carcass colour and tray colours



Double Combination Unit

- 8 shallow or 4 deep trays and 1 shelf
- W700 x D453 x H789mm

C214511* Double Combination Unit £187.40

* Please specify carcass colour and tray colours



4 Bay Kinderbox Unit

- 8 shallow or 4 deep trays
- W690 x D453 x H600mm

C214521* 4 Bay Kinderbox £191.53

* Please specify carcass colour and tray colours



6 Bay Kinderbox Unit

- 12 shallow or 6 deep trays
- W1022 x D453 x H625mm

C214531* 6 Bay Kinderbox £275.71

* Please specify carcass colour and tray colours

Please Specify:

1. Standard Carcass Colours - Beech or Maple
2. Tray colour required - see page 53 for colour options

Standard Carcass Colours



Beech *B Maple *M

Premium Carcass Colours



Lissa Oak Red Blue Green Yellow Light Grey White

Minimum quantities and additional costs apply to premium colours - please ask for details



CALL US ON 01527 878348



VISIT WWW.FORWARDPRODUCTS.CO.UK



A



B



C



D



Maple Storage Range

- Exciting new storage range with a wide variety of complementary units
- Create stunning effects with coloured display panels and bright trays
- Maple carcass
- Grattells trays supplied free of charge with all units, see below for colour options
- **Please see Important Furniture Ordering Information on page 3 before placing your furniture order**

A 6 Shallow Tray Unit

- W360 x D473 x H667mm

C214211 6 Shallow Tray Unit £139.45

* Please specify display panel colour & tray colours

B 12 Shallow Tray Unit

- W700 x D473 x H667mm

C214221 12 Shallow Tray Unit £215.58

* Please specify display panel colour & tray colours

C 18 Shallow Tray Unit

- W1030 x D473 x H667mm

C214231 18 Shallow Tray Unit £287.99

* Please specify display panel colour & tray colours

D 24 Shallow Tray Unit

- W1030 x D473 x H839mm

C214241 24 Shallow Tray Unit £360.41

* Please specify display panel colour & tray colours

Please Specify:

1. Panel colour
2. Tray colour

Carcass Colour



Maple

Display Panel Colour Options



Lime



Cyan



Tangerine



White

Tray Colour Options



Lime



Cyan



Tangerine



White



Clear



Maple Storage Range

- When ordering please specify:
 1. Tray colour required - see previous page for options
 2. Display panel colour - see previous page for options
- **Please see Important Furniture Ordering Information on page 3 before placing your furniture order**

A 8 Jumbo Tray Unit

- W1358 x D473 x H790mm

C214251 8 Jumbo Tray Unit £327.95

* Please specify display panel colour & tray colours



B

B 12 Jumbo Tray Unit

- W1358 x D473 x H1115mm

C214261 12 Jumbo Tray Unit £469.17

* Please specify display panel colour & tray colours



D

C 12 Variety Tray Unit

- W1358 x D473 x H752mm

C214271 12 Variety Tray Unit £342.38

* Please specify display panel colour & tray colours



D Angled Unit with 6 Deep Trays

- W1030 x D473 x H877mm

C214281 Angled Unit with 6 Deep Trays £239.72

* Please specify display panel colour & tray colours



F

E Double Sided Library Unit

- Double sided unit with 3 coloured angled shelves both sides
- W1040 x D502 x H883mm

C214291 Double Sided Library Unit £221.90



F 12 Compartment Locker Unit

- Unit supplied with door colours as pictured
- W1358 x D493 x H1067mm

C214311 12 Compartment Locker Unit £650.91



Maple Storage Range

- Extensive collection of units to complement the main Maple storage range
- **Please see Important Furniture Ordering Information on page 3 before placing your furniture order**

A Book Ladder

- W598 x D414 x H1245mm

| | | |
|---------|-------------|---------|
| C214331 | Book Ladder | £221.90 |
|---------|-------------|---------|



B 6 Bay Kinderbox with Coloured Panels

| | | |
|----------|---|---------|
| C214341 | Kinderbox - With Wheels W886 x D600 x H273mm | £158.10 |
| C214342* | Kinderbox - With Legs W886 x D600 x H430mm | £158.10 |

* Please specify frame colour - see below



C 6 Bay Kinderbox Tray Unit

- 12 shallow or 6 deep trays
- W1022 x D473 x H600mm

| | | |
|---------|---------------------------|---------|
| C214351 | 6 Bay Kinderbox Tray Unit | £277.39 |
|---------|---------------------------|---------|



D 6 Bay Kinderbox Shelf Unit

- Brightly coloured inner panels and 1 fixed shelf each side
- W1015 x D450 x H820mm

| | | |
|---------|----------------------------|---------|
| C214361 | 6 Bay Kinderbox Shelf Unit | £244.71 |
|---------|----------------------------|---------|

Please Specify:

1. Panel colour
2. Tray colour

Carcass Colour



Maple

Display Panel & Leg Frame Colour Options



Lime



Cyan



Tangerine



White

Tray Colour Options



Lime



Cyan



Tangerine



White



Clear



Maple Storage Range

A Art Cupboard

- 16 trays and 7 shelves
- W1085 x D600 x H1503mm (when closed)

| | | |
|---------|--------------|---------|
| C214381 | Art Cupboard | £715.27 |
|---------|--------------|---------|

Please see Important Furniture Ordering Information on page 3 before placing your furniture order



A

B Dressing Up Cupboard

- 16 trays, 1 shelf, 2 hanging rails and mirror
- W1085 x D600 x H1503mm

| | | |
|---------|----------------------|---------|
| C214391 | Dressing Up Cupboard | £798.90 |
|---------|----------------------|---------|



B

C Book House with Trays

- Double-sided unit with coloured angled top
- W910 x D568 x H1011mm

| | | |
|---------|-----------------------------|---------|
| C214371 | 3 Deep Trays & 1 Shelf | £219.68 |
| C214372 | 3 Deep & 2 Extra Deep Trays | £228.07 |



C

D Book House with 7 Slots

- W910 x D568 x H1011mm

| | | |
|---------|-------------------------|---------|
| C214321 | Book House with 7 Slots | £244.11 |
|---------|-------------------------|---------|



D

Please Specify:

1. Panel colour
2. Tray colour

Carcass Colour



Maple

Display Panel Colour Options



Lime



Cyan



Tangerine



White

Tray Colour Options



Lime



Cyan



Tangerine



White



Clear



CALL US ON 01527 878348



VISIT WWW.FORWARDPRODUCTS.CO.UK

Tip:
Mix and match
top units and
base units to suit
your needs



Cloakroom Unit

- W1360 x D345 x H1325mm

| | | | |
|---------|------------------------------|------|---------|
| C214411 | Upright Bars | pk 2 | £30.25 |
| C214412 | Top Unit with 8 Compartments | | £244.11 |
| C214413 | Base Unit with 4 Deep Trays | | £220.30 |

Maple Storage Range

- Please see Important Furniture Ordering Information on page 3 before placing your furniture order

When ordering please specify:

1. Frame colour (on cloakroom units only) - see below for options
2. Tray colour (if necessary) - see below for options
3. Top unit required (on cloakroom units only)
4. Base unit required (on cloakroom units only)
5. Every cloakroom unit must include upright bars, a top unit and a base unit



Cloakroom Unit

- W1360 x D345 x H1325mm

| | | | |
|---------|--------------------------------|------|---------|
| C214411 | Upright Bars | pk 2 | £30.25 |
| C214414 | Top Unit with Hanging Rail | | £151.99 |
| C214415 | Base Unit with 8 Shallow Trays | | £270.74 |



Cloakroom Unit

- W1360 x D345 x H1325mm

| | | | |
|---------|-------------------------------|------|---------|
| C214411 | Upright Bars | pk 2 | £30.25 |
| C214416 | Top Unit with 4 Compartments | | £195.33 |
| C214417 | Base Unit with 4 Compartments | | £195.33 |



Cloakroom Unit

- W1360 x D345 x H1325mm

| | | | |
|---------|----------------------------|------|---------|
| C214411 | Upright Bars | pk 2 | £30.25 |
| C214418 | Top Unit with 8 Coat Hooks | | £153.15 |
| C214419 | Base Unit with Rack | | £290.77 |

Please Specify:

1. Frame colour
2. Tray colour

Carcass Colour



Maple

Frame Colour Options



Lime



Cyan



Tangerine



White

Tray Colour Options



Lime



Cyan



Tangerine



White



Clear



Static Metal Storage

- The same sturdy construction as the mobile metal storage units but with rubber feet instead of castors
- Supplied complete with light grey worktop
- When ordering please specify:
 1. Frame colour, see page 80 for options
 2. Tray colours, see page 53 for options
- **Please see Important Furniture Ordering Information on page 3 before placing your furniture order**



A Metal 8 Tray Unit

- W370 x D430 x H850mm

C214591 Metal 8 Tray Static Unit £198.10

* Please specify frame colour & tray colours

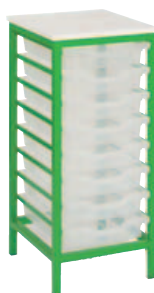

A



B

B Metal 16 Tray Unit

- W710 x D430 x H850mm

C214611 Metal 16 Tray Static Unit £207.81

* Please specify frame colour & tray colours



C



D

C Metal 24 Tray Unit

- W1050 x D430 x H850mm

C214621 Metal 24 Tray Static Unit £291.33

* Please specify frame colour & tray colours



E



F

D Metal 45 Tray Unit

- W1050 x D430 x H1510mm

C214631 Metal 45 Tray Static Unit £501.64

* Please specify frame colour & tray colours

E Metal 38 Tray Unit

- W710 x D430 x H1830mm

C214641 Metal 38 Tray Static Unit £403.97

* Please specify frame colour & tray colours

F Metal 57 Tray Unit

- W1050 x D430 x H1830mm

C214651 Metal 57 Tray Static Unit £539.93

* Please specify frame colour & tray colours

Gratnells trays
supplied free of
charge with all units
- see page 53 for
colours



Mobile Metal Storage

- Popular mobile storage units with durable steel frame and heavy duty castors
- Whilst often used in science labs, art rooms and tech areas because of the metal frame and solid worktop, these units are suitable for any area of the school
- Supplied complete with light grey worktop, trays and industrial castors
- **Please see Important Furniture Ordering Information on page 3 before placing your furniture order**

A Metal 6 Tray Unit

- W370 x D430 x H685mm

| | | |
|---------|--------------------------|---------|
| C214541 | Metal 6 Tray Mobile Unit | £142.00 |
|---------|--------------------------|---------|

* Please specify frame colour & tray colours

B Metal 12 Tray Unit

- W710 x D430 x H685mm

| | | |
|---------|---------------------------|---------|
| C214551 | Metal 12 Tray Mobile Unit | £210.31 |
|---------|---------------------------|---------|

* Please specify frame colour & tray colours

C Metal 18 Tray Unit

- W1050 x D430 x H685mm

| | | |
|---------|---------------------------|---------|
| C214561 | Metal 18 Tray Mobile Unit | £270.74 |
|---------|---------------------------|---------|

* Please specify frame colour & tray colours

D Metal 24 Tray Unit

- W1050 x D430 x H855mm

| | | |
|---------|---------------------------|---------|
| C214571 | Metal 24 Tray Mobile Unit | £360.14 |
|---------|---------------------------|---------|

* Please specify frame colour & tray colours

E Sports Trolley

- Perfect for storing PE equipment
- 6 jumbo trays
- W1050 x D430 x H1510mm

| | | |
|---------|----------------|---------|
| C214581 | Sports Trolley | £419.51 |
|---------|----------------|---------|

* Please specify frame colour & tray colours

Please Specify:

1. Frame colour
2. Tray colour required - see page 53 for colour options

Frame Colour Options



Top Colour



Laptop Storage & Charging Units

Lapcabby - Horizontal

- 16 and 32 laptop trolley
- Stored on an individual sliding tray for improved accessibility
- Lockable unit to securely store and recharge laptops - sequential power supply included
- Rear facing doors allows easy access to the individual AC adapters supplied with laptops
- The Power7 timer allows schools to program which time each day they would prefer to charge their laptops according to the class schedule or Economy 7 to reduce energy bills
- An innovative cable storage system that keeps cables compact, neat and tidy

| | | |
|------------|--|----------|
| A. J214941 | LapCabby 16 Horizontal W857 x D703 x H1215mm | £1440.54 |
| B. J214942 | LapCabby 32 Horizontal W1291 x D703 x H1215mm | £2147.49 |

* Please specify trim colour



When ordering please specify:
Trim colour required



A



B



Smooth rounded corners
for safety when moving



Please see Important Furniture Ordering Information on page 3 before placing your furniture order

Lapcabby - Vertical

- 10, 15 (includes projector and printer storage), 16 and 20 port laptop trolley
- Lockable unit to securely store and recharge laptops - sequential power supply included
- Specifically designed and tested air venting system maintains the security of the unit whilst increasing ventilation
- Soft rubber grips cushion and protect laptops when in storage and large L-shaped doors and sliding shelves provide easy, clear access to laptop storage compartment

| | | |
|------------|--|----------|
| C. J214931 | LapCabby 10 Vertical W616 x D703 x H1115mm | £791.58 |
| D. J214932 | LapCabby 15 Vertical W1015 x D703 x H1115mm | £1184.03 |
| E. J214933 | LapCabby 16 Vertical W1015 x D703 x H1115mm | £983.29 |
| F. J214934 | LapCabby 20 Vertical W1015 x D703 x H1115mm | £1126.46 |

* Please specify trim colour



C



D



E



F



CALL US ON 01527 878348



VISIT WWW.FORWARDPRODUCTS.CO.UK



4

Early Years Furniture

| | |
|-----------------|-------|
| Tables & Chairs | 84-85 |
| Themed Tables | 86 |
| Storage | 87 |
| Soft Seating | 88-91 |



Beech Tables

- High quality long lasting tables
- Durable laminated tops with solid beech frame
- Meets EN1729 Part 1 primary height regulations
- Rounded bullnosed edged tops for extra durability and added safety
- Quick and easy installation, please call if you require cost for installation
- **Please see Important Furniture Ordering Information on page 3 before placing your furniture order**

Top Colour Options



Beech

Blue

Rectangular Tables

- 1100 x 550mm, three height options
- Option for Beech or Blue tops

| | | |
|---------|--------------------|---------|
| E211121 | Beech Table H530mm | £132.99 |
| E211122 | Beech Table H590mm | £132.99 |
| E211123 | Beech Table H640mm | £132.99 |

| | | |
|---------|-------------------|---------|
| E211124 | Blue Table H530mm | £132.99 |
| E211125 | Blue Table H590mm | £132.99 |
| E211126 | Blue Table H640mm | £132.99 |



Trapezoidal Tables

- 1100 x 550mm, three height options
- Option for Beech or Blue tops

| | | |
|---------|--------------------|---------|
| E211131 | Beech Table H530mm | £132.99 |
| E211132 | Beech Table H590mm | £132.99 |
| E211133 | Beech Table H640mm | £132.99 |

| | | |
|---------|-------------------|---------|
| E211134 | Blue Table H530mm | £132.99 |
| E211135 | Blue Table H590mm | £132.99 |
| E211136 | Blue Table H640mm | £132.99 |



Beech Chairs

- Popular solid hardwood chair with either coloured seats and backs or a Beech finish
- The chairs are stackable and are available in three heights
- Supplied in packs of 2, please call for a price if you require less than pack of 2

| | | | |
|---------|--------------------|------|--------|
| E211141 | Beech Chair H310mm | pk 2 | £80.11 |
| E211142 | Beech Chair H350mm | pk 2 | £82.14 |
| E211143 | Beech Chair H380mm | pk 2 | £84.39 |

| | | | |
|---------|-------------------|------|--------|
| E211144 | Blue Chair H310mm | pk 2 | £80.11 |
| E211145 | Blue Chair H350mm | pk 2 | £82.14 |
| E211146 | Blue Chair H380mm | pk 2 | £84.39 |

Chair Colour Options



Please see Important Furniture Ordering Information on page 3 before placing your furniture order



Rectangular Height Adjustable Table

- Premium quality table with sturdy 25mm laminated tops
- Durable moulded PVC edges
- Self levelling feet, perfect for uneven floors
- Powder coated scratch resistant black frames
- Size: W1500 x D750mm
- Adjustable height in 25mm increments: nominal 430-635mm

| | | |
|---------|-------------------------|---------|
| E211151 | Rectangular Table, Red | £193.88 |
| E211152 | Rectangular Table, Blue | £193.88 |

Table Colour Options



Teachers Flower Height Adjustable Table

- The same high quality 25mm laminated tops, moulded PVC edges and self levelling feet as the rectangular tables
- Size: 1525mm diameter
- Adjustable height in 25mm increments: nominal 430-635mm

| | | |
|---------|-----------------------------|---------|
| E211161 | Teachers Flower Table, Red | £284.40 |
| E211162 | Teachers Flower Table, Blue | £284.40 |



CALL US ON 01527 878348



VISIT WWW.FORWARDPRODUCTS.CO.UK



Themed Tables

- Premium quality height adjustable tables perfect for group work, these theme tables are very popular in primary schools, special schools and nurseries
- Sturdy 25mm laminated tops with moulded black PVC edges
- Self levelling feet, perfect for uneven floors
- Scratch resistant black powder coated frames
- Quick and easy installation, please call if you require cost for installation
- **Please see Important Furniture Ordering Information on page 3 before placing your furniture order**

Table Colour Options



Blue Red Yellow

Great for early years group work



Horseshoe Table

- The horseshoe table is one of the largest of our themed tables
- Top size 1520 x 1442mm
- Height adjustable from 430 - 635mm

| | | |
|---------|------------------|---------|
| E211171 | Red Horseshoe | £294.74 |
| E211172 | Blue Horseshoe | £294.74 |
| E211173 | Yellow Horseshoe | £294.74 |



Clover Table

- This table has a top shape designed for group work and interaction
- Top size is 1200 x 1200mm
- Height adjustable from 430 - 635mm

| | | |
|---------|-------------------|---------|
| E211191 | Red Clover Table | £158.71 |
| E211192 | Blue Clover Table | £158.71 |



Arc Table

- This table, like the horseshoe shape is specially developed for work with teachers
- Top size 750 x 1500mm
- Height adjustable from 430 - 635mm

| | | |
|---------|------------------|---------|
| E211181 | Red Arc Table | £191.29 |
| E211182 | Blue Arc Table | £191.29 |
| E211183 | Yellow Arc Table | £191.29 |



Flower Table

- This table has a top shape designed for group work like the Clover table but a bit larger for 6+ students
- Top size 1525 x 1525mm
- Height adjustable from 430 - 635mm

| | | |
|---------|---------------------|---------|
| E211211 | Red Flower Table | £249.35 |
| E211212 | Blue Flower Table | £249.35 |
| E211213 | Yellow Flower Table | £249.35 |





9 Bin Tilt Storage

- Complete with strong lockable castors
- Each pack includes 9 colourful storage bins, each one with a clear plastic lid
- Manufactured from strengthened tubular plastic (flat packed)
- Bin Dimensions: H140mm x W230mm x L360mm
- Size (assembled): H838 x W838 x D381mm

| | | |
|---------|-------------------|---------|
| E211214 | Tilt Storage Unit | £151.50 |
|---------|-------------------|---------|



18 Bin Mobile Storage

- Complete with strong lockable castors
- Each pack includes 18 colourful storage bins, each one with a clear plastic lid
- Manufactured from strengthened tubular plastic (flat packed)
- Bin Dimensions: H140mm x W230mm x L360mm
- Size (assembled): H838 x W838 x D838mm

| | | |
|---------|---------------------|---------|
| E211215 | Mobile Storage Unit | £300.74 |
|---------|---------------------|---------|

Please see Important Furniture Ordering Information on page 3 before placing your furniture order



3 Shelf Maple Bookcase

- Manufactured from 15mm MDF (flat packed)
- At assembly, shelves can be adjusted every 96mm
- Size (assembled): H725 x W900 x D300mm

| | | |
|---------|----------------|---------|
| E211216 | Maple Bookcase | £186.84 |
|---------|----------------|---------|

3 Shelf Primary Coloured Bookcase

| | | |
|---------|-------------------|---------|
| E211217 | Coloured Bookcase | £186.84 |
|---------|-------------------|---------|



Big Book Holder – Maple

- Manufactured from 15mm MDF (flat packed)
- 4 separate compartments for storing up to 50 Big Books, each compartment measures 107mm width
- Supplied complete with plastic feet
- Size (assembled): H555 x W510 x D420mm

| | | |
|---------|-----------------------|---------|
| E211218 | Maple Big Book Holder | £166.89 |
|---------|-----------------------|---------|

Big Book Holder Primary Coloured

| | | |
|---------|--------------------------|---------|
| E211219 | Coloured Big Book Holder | £166.89 |
|---------|--------------------------|---------|



CALL US ON 01527 878348



VISIT WWW.FORWARDPRODUCTS.CO.UK

 Now available in anti-microbial woven fabric, effective against Covid-19 see page 262

Allsorts Seating

- Join our Allsorts range together for a complete chair, sofa and table set
- The top is set within an upholstered lip for safety
- Popular colour options below, please see further fabric and vinyl options on pages 258-265



Allsorts Modular Chair

- W440 x D470 x SH350 / Overall Height 600mm

E211472 £227.12

* Please specify colour required

Allsorts Modular Sofa

- W880 x D470 x SH350 / Overall Height 600mm

E211473 £287.24

* Please specify colour required

Please see Important Furniture Ordering Information on page 3 before placing your furniture order



Allsorts Modular Beech Top Table

- W470 x D470 x H350mm

E211474 £262.19

* Please specify colour required

Popular Colour Options
Main Line Plus Fabric

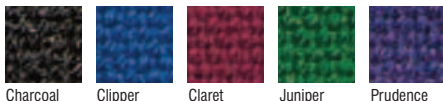

Anti-microbial Just Colour Vinyl (add 15% to prices)

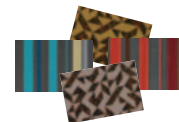

See pages 258-265 for further fabric options



Notes Seating

- Hardwearing seating range perfect for infant breakout and reading areas
- Fun design available in range of bright faux leather finishes
- One, two and three seater options
- Popular colour options shown on previous page, please see further fabric and vinyl options on pages 258-265
- **Please see Important Furniture Ordering Information on page 3 before placing your furniture order**



Single Seater

- Overall height 600mm
- W400 x D450 x SH360mm
- Popular colour options shown on previous page, please see further fabric and vinyl options on pages 258-265

| | | |
|---------|-------------------------------|---------|
| E211414 | Single Seater - Single Colour | £237.01 |
| E211415 | Single Seater - Two Tone | £237.01 |

* Please specify colour required

Mix & Match Colours to Produce Stunning Effects

Now available in anti-microbial woven fabric, effective against Covid-19 see page 262



Two Seater

- Overall height 600mm
- W820 x D450 x SH360mm
- Popular colour options shown on previous page, please see further fabric and vinyl options on pages 258-265

| | | |
|---------|--------------------------|---------|
| E211416 | 2 Seater - Single Colour | £304.84 |
| E211417 | 2 Seater - Two Tone | £304.84 |

* Please specify colour required



Three Seater

- Overall height 600mm
- W1300 x D450 x SH360mm
- Popular colour options shown on previous page, please see further fabric and vinyl options on pages 258-265

| | | |
|---------|--------------------------|---------|
| E211418 | 3 Seater - Single Colour | £347.93 |
| E211419 | 3 Seater - Two Tone | £347.93 |

* Please specify colour required

Tech2 Cloakroom Trolley

- 12 double coat/bag hooks each side to store 24 coats
- Perspex name card-holders for easy location and identification hooks
- Large base stand for shoes & bags etc. with a centre divide & lip for holding items (shelf depth each side 260mm)
- Label holder on end panel to identify name/class/year
- Reinforced powder coated (EPC) scratch resist and tubular frame structure gives superior strength
- Tested to BS58873 strength and stability standards
- Supplied flat packed for simple self assembly
- Size: W1300 x D740 x H1220mm



| | | |
|---------|-------------------|--------------|
| E211541 | Cloakroom Trolley | each £356.67 |
|---------|-------------------|--------------|



CALL US ON 01527 878348



VISIT WWW.FORWARDPRODUCTS.CO.UK



+ Now available in anti-microbial woven fabric, effective against Covid-19 see page 262

Please see Important Furniture Ordering Information on page 3 before placing your furniture order

Versatile Seat Pods

- Colourful and fun these seat pods are great for reading corners and libraries
- Wipe clean finish also suitable for outdoor use
- Size: H200 x D380mm
- Assorted pack contains one each of Red, Blue, Green, Purple and Grey

E211236 Assorted pk 5 £136.62

Multicoloured Bean Bag

- Bring reading corners to life with these vibrant bean bags
- Waterproof and wipe clean
- Size: H750 x D640mm
- Bright orange, green and blue finish

E211341 Multicoloured Bean Bag £75.35

Kaleido Seating

- An armchair and sofa just the right size for children to get comfortable on
- Tough enough for group environments but stylish enough to have at home
- These chairs look particularly striking when the arms and seats are finished in different colours
- Popular colour options below, please see further fabric and vinyl options on pages 258-265



Kaleido 2 Seater Sofa

- Overall: W900 x D540 x H560mm
Seat: W780 x D380 x H320mm
Arm height: 445mm

E211311 2 Seater - Single Colour each £335.67
E211312 2 Seater - Two Tone each £354.04

* Please specify colour required

Kaleido Armchair

- Overall: W600 x D540 x H560mm
Seat: W380 x D380 x H320mm
Arm height: 445mm

E211321 Armchair - Single Colour each £297.26
E211322 Armchair - Two Tone each £312.29

* Please specify colour required

Popular Colour Options

Main Line Plus Fabric

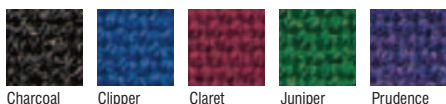

Charcoal

Clipper

Claret

Juniper

Prudence

Anti-microbial Just Colour Vinyl (add 15% to prices)



Grape

Ocean Blue

Citrus Green

Cool Blue

Deep Rose

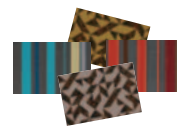

See pages 258-265 for further fabric options





Segment Soft Seating

- Tough enough to take rough and tumble treatment, yet light enough for children to move around
- Mix colour schemes and other items from our range to create your own personal seating environment
- Popular colour options shown on previous page, please see further fabric and vinyl options on pages 258-265
- **Please see Important Furniture Ordering Information on page 3 before placing your furniture order**

 Now available in anti-microbial woven fabric, effective against Covid-19 see page 262

A Segment Circular Chair

- Overall height 510mm
W400 x D400 x H300mm

| | | | |
|---------|--------------------------------|------|---------|
| E211351 | Circular Chair - Single Colour | each | £125.25 |
| E211352 | Circular Chair - Two Tone | each | £130.26 |

* Please specify colour required

B Segment Circular Pouffe

- W400 x D400 x H300mm

| | | | |
|---------|-----------------|------|---------|
| E211361 | Circular Pouffe | each | £111.89 |
|---------|-----------------|------|---------|

* Please specify colour required

C Segment Dogbone Pouffe

- W310 x D400 x H300mm

| | | | |
|---------|----------------|------|---------|
| E211371 | Segment Pouffe | each | £111.89 |
|---------|----------------|------|---------|

* Please specify colour required

D Segment Curved Pouffe

- W350 x D400 x H300mm

| | | | |
|---------|---------------|------|---------|
| E211381 | Curved Pouffe | each | £111.89 |
|---------|---------------|------|---------|

* Please specify colour required

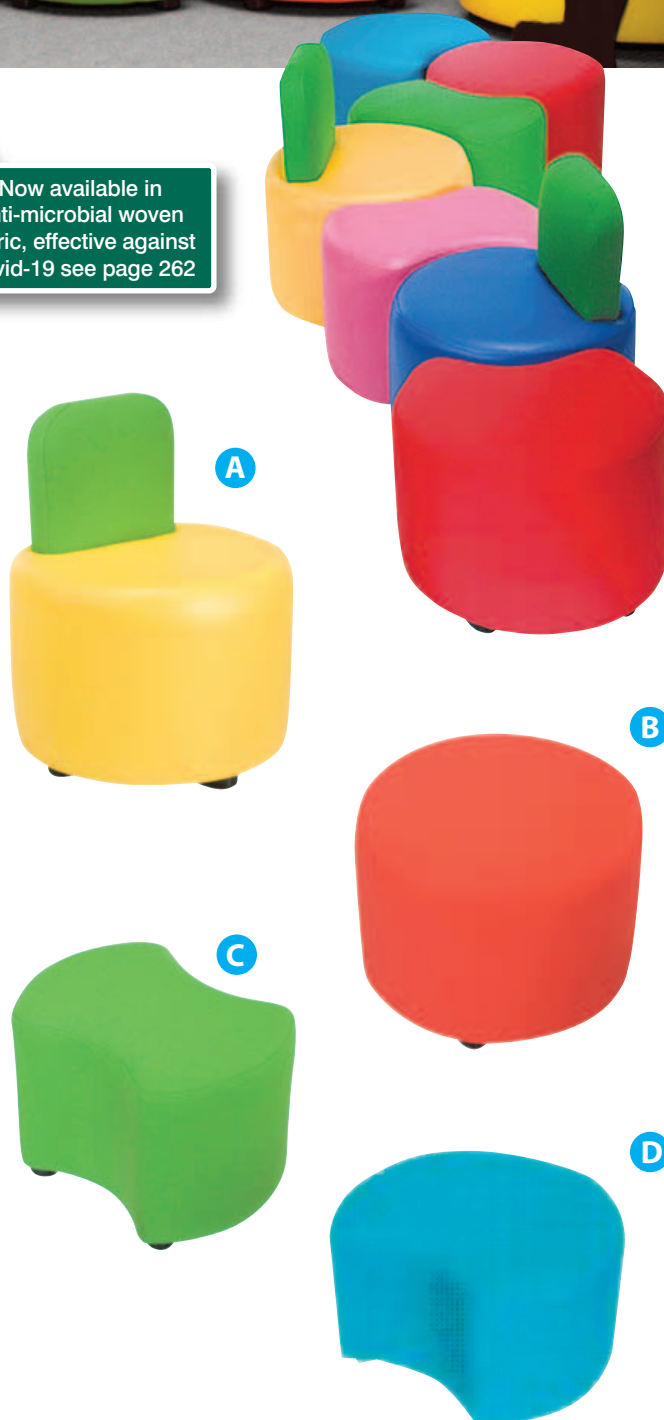



5

Healthcare

| | |
|-------------------------------|-------|
| Covid Testing Pods | 94 |
| Floor Standing Screens | 95 |
| Testing Booths | 96-97 |
| Free-standing Desktop Screens | 98-99 |



Swab procedure posters and sanitary equipment illustrated in the document not supplied.

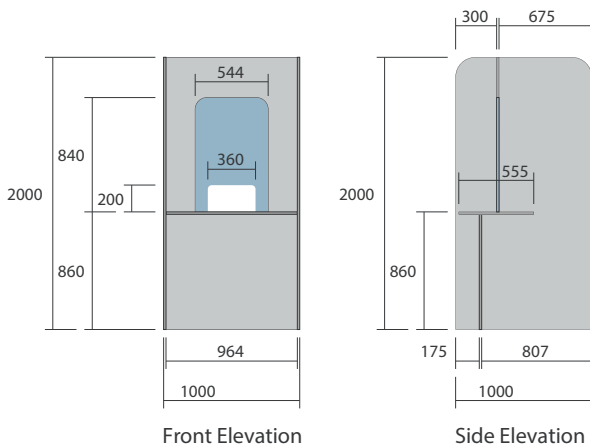
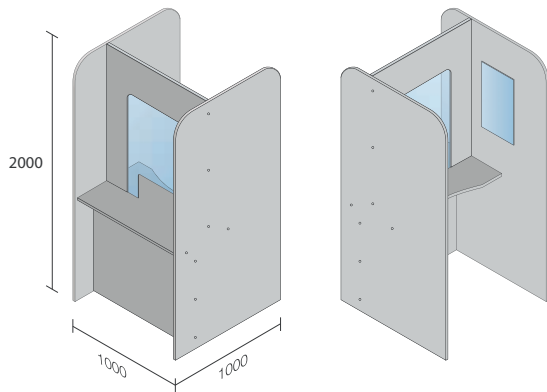

A. COVID Testing Pods - Grey

- Our Freestanding COVID Testing Pods provide a discreet and efficient area for staff and students and are designed to achieve a comfortable area while performing RNA tests
- Made from heavy duty MFC, they are both sturdy, practical and aesthetically pleasing, quick to install and can be easily moved around in your testing area as requirements evolve
- The acrylic safety screen has a cut out slot 200mm high x 360mm wide, which is large enough to post a test tube through inside a holder
- Mirror included for a participant to observe their RNA swab procedure
- 1000 x 1000 x H2000mm

| | 1-4 | 5-9 | 10+ |
|--------|---------|---------|---------|
| CP1001 | £577.23 | £548.49 | £498.49 |

- COVID testing pod as above but with heavy duty lockable castors
- Enables easy moving for greater flexibility

| | | |
|--------|----------------------------------|---------|
| CP1011 | Testing Pod with Locking Castors | £672.23 |
|--------|----------------------------------|---------|



A. Retractable Barrier Black Frame/Black Belt

- Ideal for channelling queues
- 2.5m long and connects into position with a 4-way safety button
- For indoor use
- £25 delivery charge

RB25 each £34.29



B. Mobile Medical Floor Standing Privacy Screen - White

- Free-standing mobile privacy screen
- Additional screens can be linked via a linking hinge
- Supplied with two individual locking castors
- Steel frame surrounds and leg supports MDF screen providing an acoustic barrier
- Screens can be nested when not in use to save space
- 100% recyclable and easily cleaned
- W1000 x H1900mm

MFSPS £246.15



C. Opaque Health Screen

- Our opaque healthcare screens are easy to assemble, hygienic and low maintenance making them ideal for COVID testing areas
- The top and bottom panels are made from easy clean opaque Akare material
- The sturdy steel frame and H base plates are powder-coated in matt black
- Supplied as a flat pack – 20 mins assembly time
- Black steel frame

| | | | |
|---------|-----------------|------|---------|
| SCR750 | H1850 x W750mm | each | £199.00 |
| SCR1500 | H1850 x W1500mm | each | £279.00 |

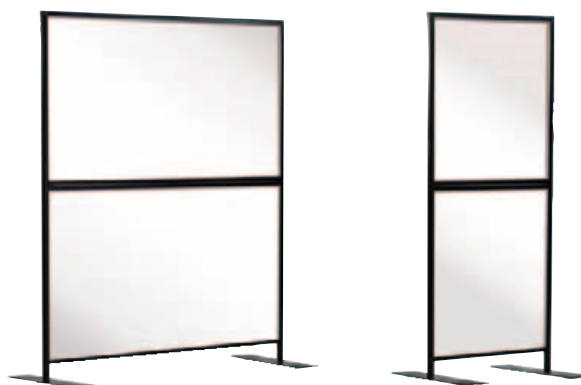

CALL US ON 01527 878348



VISIT WWW.FORWARDPRODUCTS.CO.UK



A. Singular Covid Testing Booth

- Create a safe and user friendly Covid testing area with our freestanding, modular COVID Testing Booths
- DDA Compliant design
- Choose from standalone or linking add-on modules – with two different size options for greater flexibility and DDA wheelchair access
- The simplicity of add-on modules allows them to be quickly assembled or disassembled when not required
- Supplied with a mirror, built in table top, and an acrylic safety screen with a 200mm high x 360mm wide cut out slot which is large enough to post a completed Covid test through inside a holder
- The booths streamline the whole Covid testing process, helping to cut down the time spent on each test and to improve safety
- Made from heavy duty MFC in a durable white finish, the booths are sturdy, practical and aesthetically pleasing and can be repeatedly sanitised using sprays, wipes or fogging machines
- Delivery within 2-3 weeks of ordering to mainland UK - call for a quote on installation, or for deliveries outside of mainland UK



CP2001

CP2002



CP2003

CP2004

Starter Module

| | | |
|--------|-------------------------|---------|
| CP2001 | W1250 x D2425 x H2000mm | £761.85 |
|--------|-------------------------|---------|

Add-on Module

| | | |
|--------|-------------------------|---------|
| CP2002 | W1250 x D2425 x H2000mm | £684.92 |
|--------|-------------------------|---------|

B. Fully Accessible Covid Testing Booth

Starter Module

| | | |
|--------|-------------------------|---------|
| CP2003 | W2475 x D2450 x H2000mm | £992.62 |
|--------|-------------------------|---------|

Add-on Module

| | | |
|--------|-------------------------|---------|
| CP2004 | W2450 x D2450 x H2000mm | £915.69 |
|--------|-------------------------|---------|



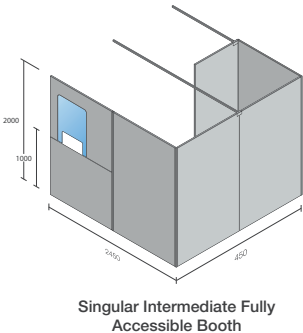
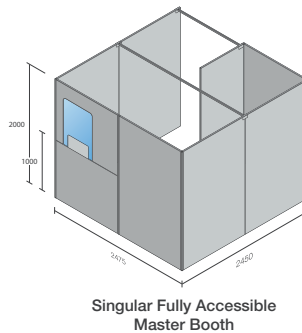
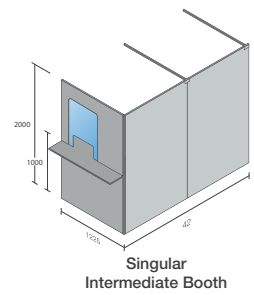
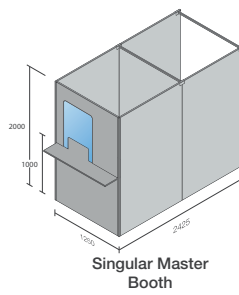
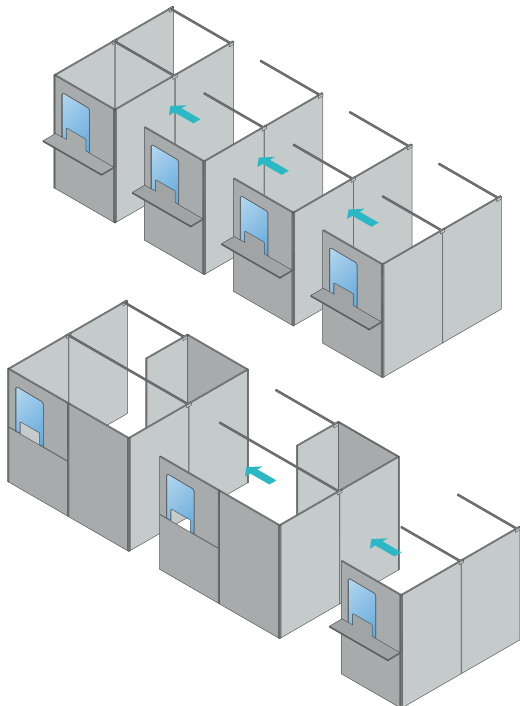

CALL US ON 01527 878348



VISIT WWW.FORWARDPRODUCTS.CO.UK



Desktop Safeguard Acrylic Screen Without Cutouts

- Free-standing screen - no fixings required
- Clear 5mm acrylic panel and support feet
- Easily assembled and disassembled
- Airborne pathogen barrier between individual people
- Can be moved freely
- No porous materials used - surfaces easily cleaned

A. 1800 & 2000mm Wide Without Cutout

- Single acrylic screen with 4 upstands

| | Size W x D x H(mm) | 1-10 | 11-25 | 26+ |
|--------|--------------------|---------|---------|---------|
| CP3001 | 1800 x 5 x 1000 | £333.00 | £320.00 | £308.00 |
| CP3002 | 1800 x 5 x 900 | £300.00 | £288.00 | £275.00 |
| CP3003 | 2000 x 5 x 800 | £295.00 | £285.00 | £273.00 |
| CP3004 | 1800 x 5 x 800 | £268.00 | £255.00 | £245.00 |
| CP3005 | 2000 x 5 x 700 | £260.00 | £248.00 | £238.00 |
| CP3006 | 1800 x 5 x 700 | £233.00 | £225.00 | £215.00 |
| CP3007 | 2000 x 5 x 600 | £223.00 | £213.00 | £205.00 |
| CP3008 | 1800 x 5 x 600 | £200.00 | £193.00 | £185.00 |

B. 600 - 1600mm Wide Without Cutout

- Single acrylic screen with 2 upstands

| | Size W x D x H(mm) | 1-10 | 11-25 | 26+ |
|--------|--------------------|---------|---------|---------|
| CP3009 | 1600 x 5 x 1000 | £295.00 | £285.00 | £273.00 |
| CP3010 | 1400 x 5 x 1000 | £260.00 | £248.00 | £238.00 |
| CP3011 | 1200 x 5 x 1000 | £223.00 | £213.00 | £205.00 |
| CP3012 | 1000 x 5 x 1000 | £185.00 | £178.00 | £170.00 |
| CP3013 | 900 x 5 x 1000 | £178.00 | £170.00 | £163.00 |
| CP3014 | 800 x 5 x 1000 | £158.00 | £153.00 | £145.00 |
| CP3015 | 700 x 5 x 1000 | £138.00 | £133.00 | £128.00 |
| CP3016 | 600 x 5 x 1000 | £118.00 | £115.00 | £110.00 |
| CP3017 | 1600 x 5 x 900 | £268.00 | £255.00 | £245.00 |
| CP3018 | 1400 x 5 x 900 | £233.00 | £225.00 | £215.00 |
| CP3019 | 1200 x 5 x 900 | £200.00 | £193.00 | £185.00 |
| CP3020 | 1000 x 5 x 900 | £168.00 | £160.00 | £153.00 |
| CP3021 | 900 x 5 x 900 | £160.00 | £153.00 | £148.00 |
| CP3022 | 800 x 5 x 900 | £143.00 | £138.00 | £130.00 |
| CP3023 | 700 x 5 x 900 | £125.00 | £120.00 | £115.00 |
| CP3024 | 600 x 5 x 900 | £108.00 | £103.00 | £98.00 |
| CP3025 | 1600 x 5 x 800 | £238.00 | £228.00 | £218.00 |
| CP3026 | 1400 x 5 x 800 | £208.00 | £200.00 | £190.00 |
| CP3027 | 1200 x 5 x 800 | £178.00 | £170.00 | £163.00 |
| CP3028 | 1000 x 5 x 800 | £148.00 | £143.00 | £135.00 |
| CP3029 | 900 x 5 x 800 | £143.00 | £138.00 | £130.00 |
| CP3030 | 800 x 5 x 800 | £128.00 | £123.00 | £118.00 |
| CP3031 | 700 x 5 x 800 | £110.00 | £105.00 | £103.00 |
| CP3032 | 600 x 5 x 800 | £95.00 | £90.00 | £88.00 |
| CP3033 | 1600 x 5 x 700 | £208.00 | £200.00 | £190.00 |
| CP3034 | 1400 x 5 x 700 | £183.00 | £175.00 | £168.00 |
| CP3035 | 1200 x 5 x 700 | £155.00 | £150.00 | £143.00 |
| CP3036 | 1000 x 5 x 700 | £130.00 | £125.00 | £120.00 |
| CP3037 | 900 x 5 x 700 | £125.00 | £120.00 | £115.00 |
| CP3038 | 800 x 5 x 700 | £110.00 | £105.00 | £103.00 |
| CP3039 | 700 x 5 x 700 | £98.00 | £93.00 | £90.00 |
| CP3040 | 600 x 5 x 700 | £83.00 | £80.00 | £78.00 |
| CP3041 | 1600 x 5 x 600 | £178.00 | £170.00 | £163.00 |
| CP3042 | 1400 x 5 x 600 | £155.00 | £150.00 | £143.00 |
| CP3043 | 1200 x 5 x 600 | £133.00 | £128.00 | £123.00 |
| CP3044 | 1000 x 5 x 600 | £110.00 | £108.00 | £103.00 |
| CP3045 | 900 x 5 x 600 | £108.00 | £103.00 | £98.00 |
| CP3046 | 800 x 5 x 600 | £95.00 | £90.00 | £88.00 |
| CP3047 | 700 x 5 x 600 | £83.00 | £80.00 | £78.00 |
| CP3048 | 600 x 5 x 600 | £70.00 | £68.00 | £65.00 |

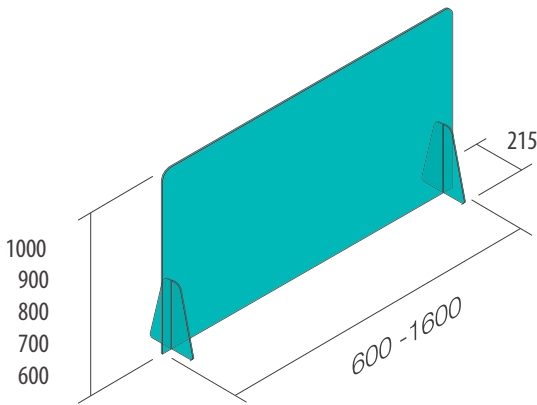
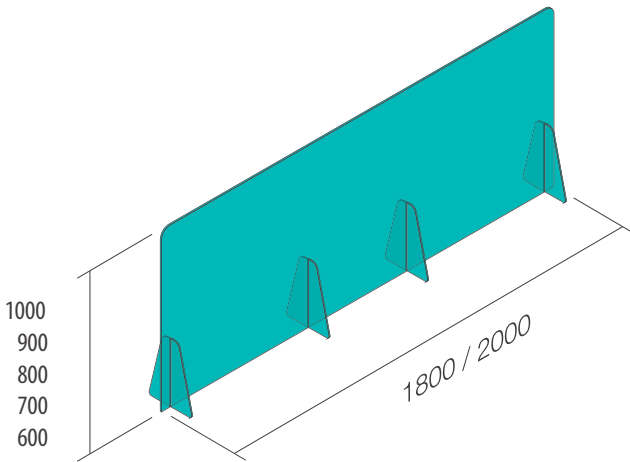

600mm, 700mm, 800mm, 900mm, 1000mm, 1200mm, 1400mm and 1600mm Wide Screens.

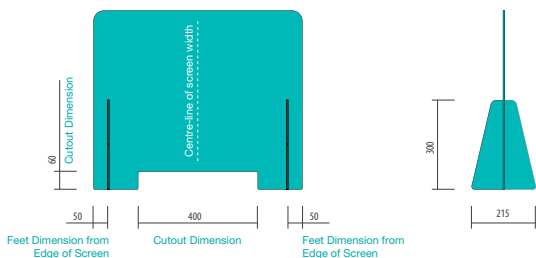

Desktop Safeguard Acrylic Screen With Cutouts

- Free-standing screen - no fixings required
- Clear 5mm acrylic panel and support feet
- Easily assembled and disassembled
- Airborne pathogen barrier between individual people
- Can be moved freely
- No porous materials used - surfaces easily cleaned

A. 1800 & 2000mm Wide With Cutout

- Single acrylic screen with 4 upstands

| | Size W x D x H(mm) | 1-10 | 11-25 | 26+ |
|--------|--------------------|---------|---------|---------|
| CP3049 | 1800 x 5 x 1000 | £333.00 | £320.00 | £308.00 |
| CP3050 | 1800 x 5 x 900 | £300.00 | £288.00 | £275.00 |
| CP3051 | 2000 x 5 x 800 | £295.00 | £285.00 | £273.00 |
| CP3052 | 1800 x 5 x 800 | £268.00 | £255.00 | £245.00 |
| CP3053 | 2000 x 5 x 700 | £260.00 | £248.00 | £238.00 |
| CP3054 | 1800 x 5 x 700 | £233.00 | £225.00 | £215.00 |
| CP3055 | 2000 x 5 x 600 | £223.00 | £213.00 | £205.00 |
| CP3056 | 1800 x 5 x 600 | £200.00 | £193.00 | £185.00 |

B. 600 - 1600mm Wide With Cutout

- Single acrylic screen with 2 upstands

| | Size W x D x H(mm) | 1-10 | 11-25 | 26+ |
|--------|--------------------|---------|---------|---------|
| CP3057 | 1600 x 5 x 1000 | £295.00 | £285.00 | £273.00 |
| CP3058 | 1400 x 5 x 1000 | £260.00 | £248.00 | £238.00 |
| CP3059 | 1200 x 5 x 1000 | £223.00 | £213.00 | £205.00 |
| CP3060 | 1000 x 5 x 1000 | £185.00 | £178.00 | £170.00 |
| CP3061 | 900 x 5 x 1000 | £178.00 | £170.00 | £163.00 |
| CP3062 | 800 x 5 x 1000 | £158.00 | £153.00 | £145.00 |
| CP3063 | 700 x 5 x 1000 | £138.00 | £133.00 | £128.00 |
| CP3064 | 600 x 5 x 1000 | £118.00 | £115.00 | £110.00 |

| | | | | |
|--------|----------------|---------|---------|---------|
| CP3065 | 1600 x 5 x 900 | £268.00 | £255.00 | £245.00 |
| CP3066 | 1400 x 5 x 900 | £233.00 | £225.00 | £215.00 |
| CP3067 | 1200 x 5 x 900 | £200.00 | £193.00 | £185.00 |
| CP3068 | 1000 x 5 x 900 | £168.00 | £160.00 | £153.00 |
| CP3069 | 900 x 5 x 900 | £160.00 | £153.00 | £148.00 |
| CP3070 | 800 x 5 x 900 | £143.00 | £138.00 | £130.00 |
| CP3071 | 700 x 5 x 900 | £125.00 | £120.00 | £115.00 |
| CP3072 | 600 x 5 x 900 | £108.00 | £103.00 | £98.00 |

| | | | | |
|--------|----------------|---------|---------|---------|
| CP3073 | 1600 x 5 x 800 | £238.00 | £228.00 | £218.00 |
| CP3074 | 1400 x 5 x 800 | £208.00 | £200.00 | £190.00 |
| CP3075 | 1200 x 5 x 800 | £178.00 | £170.00 | £163.00 |
| CP3076 | 1000 x 5 x 800 | £148.00 | £143.00 | £135.00 |
| CP3077 | 900 x 5 x 800 | £143.00 | £138.00 | £130.00 |
| CP3078 | 800 x 5 x 800 | £128.00 | £123.00 | £118.00 |
| CP3079 | 700 x 5 x 800 | £110.00 | £105.00 | £103.00 |
| CP3080 | 600 x 5 x 800 | £95.00 | £90.00 | £88.00 |

| | | | | |
|--------|----------------|---------|---------|---------|
| CP3081 | 1600 x 5 x 700 | £208.00 | £200.00 | £190.00 |
| CP3082 | 1400 x 5 x 700 | £183.00 | £175.00 | £168.00 |
| CP3083 | 1200 x 5 x 700 | £155.00 | £150.00 | £143.00 |
| CP3084 | 1000 x 5 x 700 | £130.00 | £125.00 | £120.00 |
| CP3085 | 900 x 5 x 700 | £125.00 | £120.00 | £115.00 |
| CP3086 | 800 x 5 x 700 | £110.00 | £105.00 | £103.00 |
| CP3087 | 700 x 5 x 700 | £98.00 | £93.00 | £90.00 |
| CP3088 | 600 x 5 x 700 | £83.00 | £80.00 | £78.00 |

| | | | | |
|--------|----------------|---------|---------|---------|
| CP3089 | 1600 x 5 x 600 | £178.00 | £170.00 | £163.00 |
| CP3090 | 1400 x 5 x 600 | £155.00 | £150.00 | £143.00 |
| CP3091 | 1200 x 5 x 600 | £133.00 | £128.00 | £123.00 |
| CP3092 | 1000 x 5 x 600 | £110.00 | £108.00 | £103.00 |
| CP3093 | 900 x 5 x 600 | £108.00 | £103.00 | £98.00 |
| CP3094 | 800 x 5 x 600 | £95.00 | £90.00 | £88.00 |
| CP3095 | 700 x 5 x 600 | £83.00 | £80.00 | £78.00 |
| CP3096 | 600 x 5 x 600 | £70.00 | £68.00 | £65.00 |

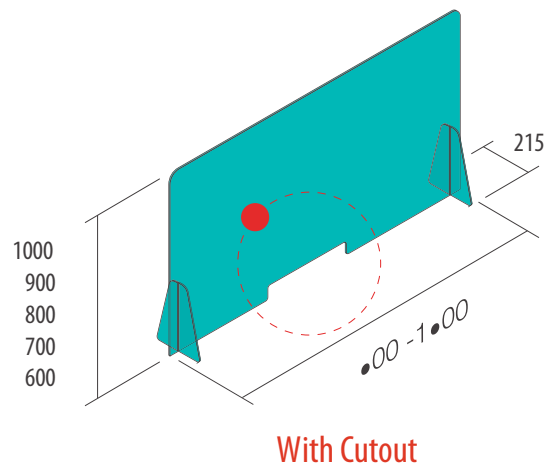
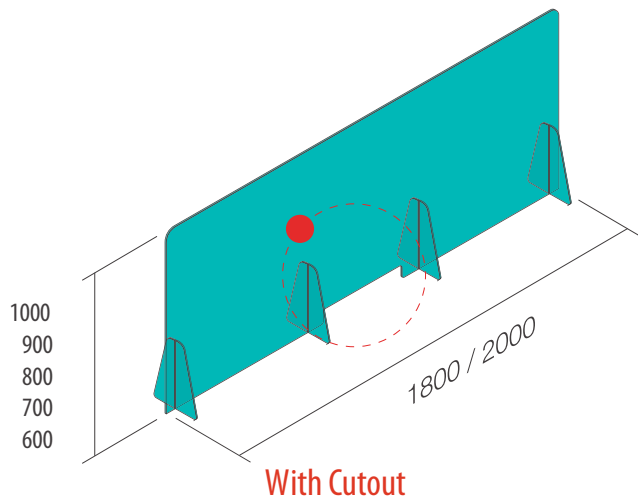

1800mm and 2000mm Wide Screens.

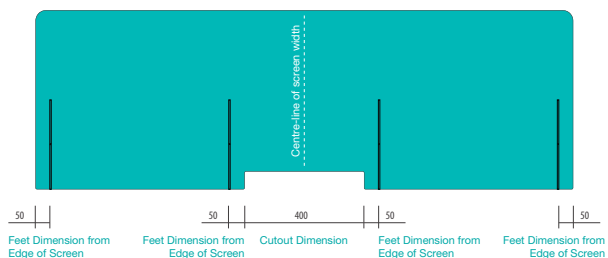

CALL US ON 01527 878348



VISIT WWW.FORWARDPRODUCTS.CO.UK



6

Office Accessories

| | |
|--------------------------|---------|
| Whiteboards | 102-105 |
| Drywipe Easels | 106-107 |
| Revolving Boards | 108 |
| Reading & Writing Centre | 109 |
| Noticeboards | 110-116 |
| Snap Display Frames | 116 |
| Display Panel Kits | 117 |
| Clocks | 118 |
| Key & First Aid Cabinets | 119 |
| Plants | 120-121 |



A



Non-returnable items, please report damages or discrepancies within 72 hours

B



C

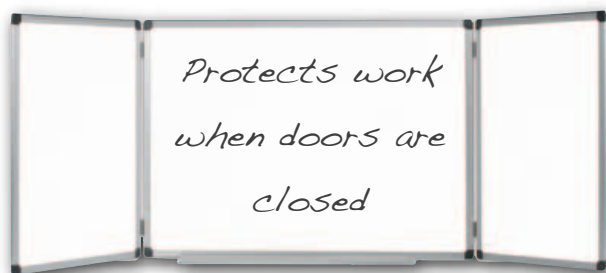

A Non-Magnetic Whiteboards

- This plain double sided whiteboard has a revolutionary new surface which is ultra smooth on both sides improving erasability and reducing ghosting
- Aluminium framed plain white surface, supplied with concealed wall fixings and pen tray
- All boards 1800mm wide and larger have extra central fixings at top and bottom for additional safety and stability

| | | | |
|--------|---------------|------|---------|
| SMDW32 | 600 x 900mm | each | £22.14 |
| SMDW43 | 900 x 1200mm | each | £32.09 |
| SMDW44 | 1200 x 1200mm | each | £42.79 |
| SMDW54 | 1500 x 1200mm | each | £54.56 |
| SMDW64 | 1800 x 1200mm | each | £59.72 |
| SMDW84 | 2400 x 1200mm | each | £74.87 |
| SMDW88 | 2700 x 1200mm | each | £138.83 |

B Magnetic Whiteboards

- This economically priced whiteboard has a revolutionary new surface which is ultra smooth to improve erasability, with the added advantage of accepting magnets
- Aluminium framed plain white drywipe surface
- Supplied with concealed wall fixings and pen tray
- All boards 1800mm wide and larger have extra central fixings at top and bottom for additional safety and stability

| | | | |
|---------|---------------|------|---------|
| SMDWM32 | 600 x 900mm | each | £33.77 |
| SMDWM43 | 900 x 1200mm | each | £50.30 |
| SMDWM44 | 1200 x 1200mm | each | £61.58 |
| SMDWM54 | 1500 x 1200mm | each | £71.50 |
| SMDWM64 | 1800 x 1200mm | each | £83.76 |
| SMDWM84 | 2400 x 1200mm | each | £104.97 |
| SMDWM88 | 2700 x 1200mm | each | £139.61 |

C Trio Whiteboards

- Unique design creates multifunctional ability
- Three separate magnetic whiteboard surfaces when open
- Aluminium framed with fixings and pen tray
- Sizes refer to central board

| | | | |
|--------|--------------|------|---------|
| TR1010 | 900 x 600mm | each | £96.04 |
| TR2020 | 1200 x 900mm | each | £154.84 |



A Vitreous Enamel Steel Magnetic Whiteboard

- Vitreous Enamel Steel - the ultimate in dry-wipe surfaces is guaranteed for 25 years - invest in the best
- Aluminium framed whiteboards with concealed corner fixings and pen tray
- Surface can be used with all brands of drywipe markers and also accept magnets
- All boards 1800mm wide and larger have extra central fixings at top and bottom for additional safety and stability

25 YEAR WARRANTY



A

| | | | |
|-------|---------------|------|---------|
| VDW32 | 900 x 600mm | each | £48.52 |
| VDW43 | 1200 x 900mm | each | £69.97 |
| VDW44 | 1200 x 1200mm | each | £95.74 |
| VDW54 | 1500 x 1200mm | each | £120.17 |
| VDW64 | 1800 x 1200mm | each | £140.64 |
| VDW84 | 2400 x 1200mm | each | £179.39 |
| VDW88 | 2700 x 1200mm | each | £229.55 |

Non-returnable items, please report damages or discrepancies within 72 hours

B Glass Magnetic Whiteboard

- Incredibly stylish whiteboards, to give your rooms the finishing touch
- Works like a standard drywipe board, with standard drywipe markers and erasers
- Available in 8 sizes, right up to 2400 x 1200mm



B

| | | | |
|---------|---------------|------|---------|
| GMW960 | 900 x 600mm | each | £97.16 |
| GMW1065 | 1000 x 650mm | each | £116.91 |
| GMW1290 | 1200 x 900mm | each | £168.06 |
| GMW1212 | 1200 x 1200mm | each | £213.77 |
| GMW1510 | 1500 x 1000mm | each | £221.85 |
| GMW1812 | 1800 x 1200mm | each | £280.03 |
| GMW2010 | 2000 x 1000mm | each | £300.46 |
| GMW2412 | 2400 x 1200mm | each | £390.19 |

Non-returnable items, please report damages or discrepancies within 72 hours

A



A Eco-Friendly Whiteboards

- The attractive contoured 35mm wide frame is available in a choice of Aluminium (AL), Blue (BL) or Light Oak (LO) effect finishes
- Almost entirely constructed from timber industry bi-products, and recycled materials
- Quality laminate drywipe surface
- Boards can be mounted portrait or landscape with fixings provided
- Made in the UK

| | | | |
|-----------|---------------|------|---------|
| EFW96** | 900 x 600mm | each | £31.44 |
| EFW129** | 1200 x 900mm | each | £45.41 |
| EFW1212** | 1200 x 1200mm | each | £55.06 |
| EFW1512** | 1500 x 1200mm | each | £71.04 |
| EFW1812** | 1800 x 1200mm | each | £80.55 |
| EFW2412** | 2400 x 1200mm | each | £110.50 |

**Please specify frame colour when ordering

Frame Options



90% RECYCLED MATERIAL

ECO FRIENDLY PRODUCTS
 These Eco-Friendly products are manufactured from sustainable and recycled raw materials and environmentally friendly manufacturing processes.

By weight these finished products use up to 90% recycled material, are assembled using solvent & VOC free adhesives, and all packaging uses recycled card.

We have also eliminated unnecessary plastic packaging and the product has the potential of 60% recyclability.



A Colour Edged Whiteboards

- Quality laminate drywipe surface
- Mounts flush to the wall due to its frameless design and simple 'through the board' fixings
- Choose from five bright colours with matching screw caps
- Low profile 2mm edge means boards can be mounted side by side virtually seamless
- Made in the UK

Non-returnable items, please report damages or discrepancies within 72 hours

| | | | |
|-----------|---------------|------|--------|
| CEW96** | 900 x 600mm | each | £26.72 |
| CEW129** | 1200 x 900mm | each | £37.27 |
| CEW1212** | 1200 x 1200mm | each | £44.38 |
| CEW1512** | 1500 x 1200mm | each | £59.32 |
| CEW1812** | 1800 x 1200mm | each | £71.50 |
| CEW2412** | 2400 x 1200mm | each | £84.88 |

**Please specify frame colour when ordering

Frame Colour Options

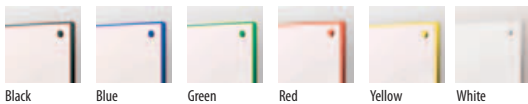

Black Blue Green Red Yellow White

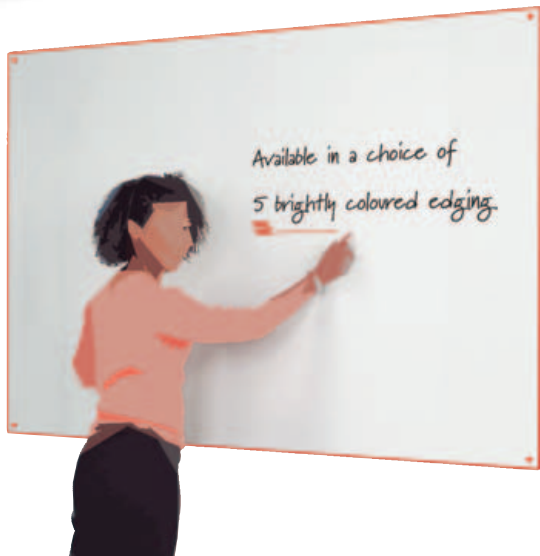

A

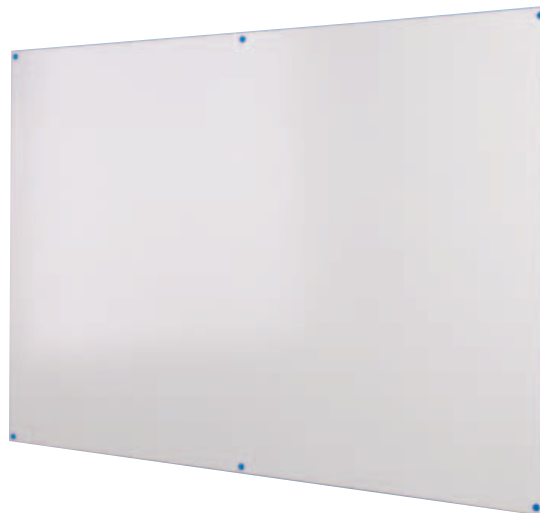

The tough ABS colour edging adds a modern accent to an everyday product

Have you seen our new range of Sienna office desking?



See pages 168-219 for details



CALL US ON 01527 878348



VISIT WWW.FORWARDPRODUCTS.CO.UK

Non-returnable items, please report damages or discrepancies within 72 hours

10 YEAR WARRANTY

A



- Magnetic drywipe surfaces
- Extremely durable, stable and safe
- Quick and easy height adjustments achievable within seconds
- Four locking castors (where illustrated)
- Available with red or blue, high gloss, powder coated frames
- Flip chart fittings (where illustrated)
- Comes complete with a manufacturer's 10 year warranty
- Full length pen ledge
- A full range of spares are available
- Where illustrated, Gratnells school storage trays are included

B



A Big A Frame Easel

- Includes two Gratnells storage trays
- White Board size: W900 x H900mm
- Height adjustable 1120, 1350, 1590 or 1800mm

| | | | |
|---------|------|------|---------|
| BAFMEBL | Blue | each | £244.21 |
| BAFMERD | Red | each | £244.21 |

B Single Sided Mobile Easel

- Includes one Gratnells storage tray
- White Board size: W600 x H900mm
- Height adjustable 1210, 1140, 1670 or 1880mm

| | | | |
|---------|------|------|---------|
| SBMEPBL | Blue | each | £214.44 |
| SBMEPRD | Red | each | £214.44 |

C



C Double Sided Mobile Easel

- Includes one Gratnells storage tray
- Front board adjustable only
- White Board size: W600 x H900mm
- Height adjustable 1220, 1440, 1680 or 1900mm

| | | | |
|---------|------|------|---------|
| DBMEPBL | Blue | each | £260.37 |
| DBMEPRD | Red | each | £260.37 |



A Double Sided Mobile Easel Landscape Style

- Includes three Gratrrells storage trays
- Boards can be stepped independently, (see illustration)
- Specifically designed for 4 – 11 year old children
- White Board size: W900 x H600mm
- Height adjustable 810, 1030 or 1350mm

| | | | |
|---------|------|------|---------|
| DBMELBL | Blue | each | £275.69 |
| DBMELRD | Red | each | £275.69 |



B Large Desktop Easel

- Designed for easy transport between classrooms
- White Board size: W600 x H600mm

| | | | |
|---------|------|------|---------|
| LMDTEBL | Blue | each | £117.20 |
| LMDTERD | Red | each | £117.20 |



C Small Individual Desktop Easel

- Specifically designed for individual pupils
- White Board size: W600 x H300mm

| | | | |
|---------|------|------|--------|
| SIDTEBL | Blue | each | £87.84 |
| SIDTERD | Red | each | £87.84 |



A



A Magnetic Revolving Whiteboards

- Mobile revolving white board with pen tray and locking castors
- Board rotates 360° and will lock at any angle
- Anodised aluminium frame board
- Gridded one side and plain on the other
- 4 year warranty on board surface

| | | | |
|----------|---------------|------|---------|
| EREV129 | 1200 x 900mm | each | £107.13 |
| EREV1212 | 1200 x 1200mm | each | £127.73 |
| EREV1215 | 1200 x 1500mm | each | £139.36 |
| EREV1218 | 1200 x 1800mm | each | £157.27 |

Non-returnable items, please report damages or discrepancies within 72 hours

B



B Tilting Portable Duo Boards

- Flipchart easel and magnetic dry wipe board on one side, notice board on the other
- Ideal where space is limited
- Height adjustable
- Portable and easy to use
- Castors lock down when in use
- Includes a bracket for holding flipchart pad

| | | | |
|----------|--------------|------|---------|
| DUONB127 | 1200 x 700mm | each | £114.01 |
|----------|--------------|------|---------|



A Royal Reading & Writing Centre

- A magnetic dry erase metal surface which also supports long chart paper, pocket charts and magnetic letters
- 24" x 34" removable and adjustable double-sided magnetic dry erase board with lines spaces 1" apart on one side – hangs long or wide
- Built-in big book storage rack
- Shelf with two built-in small tubs for marker storage
- Two magnetic bulldog clips
- Removable and width adjustable snap on hooks for chart paper, pocket charts etc
- Removable and adjustable spring loaded book/marker ledge fastens securely to front and back at nine different levels
- Four clear sliding tubs for ease of access
- Four locking castors
- Foot activated brake system
- Ten year frame warranty
- Size 76cm x 78.75cm x 145cms



A

LC500 each £315.56

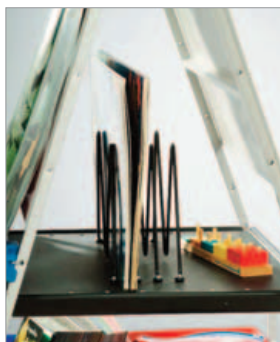

Non-returnable items, please report damages or discrepancies within 72 hours

B Junior Mobile Tilting Magnetic Whiteboard

- Practical floor standing whiteboard with plain, gridded or lined magnetic surfaces
- Double sided whiteboard mounted in a mobile frame
- Board can pivot and lock at a 40deg angle, therefore ideal for resting books or artwork on the full width ledge
- 4 castors 2 of which are braked
- Overall height 1300mm
- Choose from white frame with anodised aluminium board trim or red frame with multi-coloured board trim and a choice of grid or lines



B

| | | | |
|--------|-------------|------|---------|
| DJMWWH | White Frame | each | £116.95 |
| DJMWRE | Red Frame | each | £142.26 |

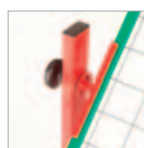

CALL US ON 01527 878348



VISIT WWW.FORWARDPRODUCTS.CO.UK

Non-returnable items, please report damages or discrepancies within 72 hours

A



B



C



Standard Felt Colours

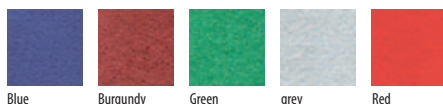

Please Specify:
Felt/fabric colour

A Unframed Noticeboards

- These frameless pinboards are made from high quality board and felt
- Fire resistant and colour fast
- Available in Blue (BL), Green (GR), Red (RD), Silver (SV) & Wine (WN)
- Can be made to a custom size - POA
- 3 largest sizes are supplied in 2 parts

| | | | |
|-----------|---------------|------|--------|
| UNB9060** | 900 x 600mm | each | £19.27 |
| UNB129** | 1200 x 900mm | each | £26.93 |
| UNB1212** | 1200 x 1200mm | each | £32.30 |
| UNB1512** | 1500 x 1200mm | each | £43.95 |
| UNB1812** | 1800 x 1200mm | each | £47.77 |
| UNB2412** | 2400 x 1200mm | each | £57.99 |

**Please specify colour when ordering

B Standard Noticeboards

- Made in the UK to the highest standards
- Felt surface accepts Velcro® as well as pins - colour fast to BS1006
- Available in 5 standard felt colours - Blue (BL), Burgundy (BG), Red (RD), Green (GR) or Grey (GY) & special fabrics for an extra charge. Please call for more information
- Other sizes/colours are available – please enquire (P.O.A.)
- Flush fix corners conceal wall fixings (supplied)
- Fire retardant fabric

| | | | |
|-----------|---------------|------|--------|
| NBS96** | 600 x 900mm | each | £23.64 |
| NBS129** | 900 x 1200mm | each | £30.44 |
| NBS1212** | 1200 x 1200mm | each | £37.63 |
| NBS1512** | 1500 x 1200mm | each | £51.26 |
| NBS1812** | 1800 x 1200mm | each | £53.40 |
| NBS2412** | 2400 x 1200mm | each | £63.44 |

** Please specify colour when ordering, see swatch at bottom of page

C Standard Tamperproof Noticeboards

- Inexpensive solution to protect displays from casual interference
- Each door secures with 2 matching lock for convenience
- Felt surface accepts Velcro® as well as pins - colour fast to BS1006
- Available in 5 standard felt colours - Blue (BL), Burgundy (BG), Green (GR), Grey (GY) or Red (RD) and special fabrics for an additional charge. Please call for more information
- Other sizes/colours are available – please enquire (P.O.A.)
- Fire Retardant Fabric

Single Door

| | | | |
|---------|---------------|------|---------|
| LNB21** | 600 x 450mm | each | £48.57 |
| LNB32** | 600 x 900mm | each | £56.91 |
| LNB33** | 900 x 900mm | each | £72.89 |
| LNB43** | 1200 x 900mm | each | £86.70 |
| LNB44** | 1200 x 1200mm | each | £116.56 |

Double Doors

| | | | |
|---------|---------------|------|---------|
| LNB64** | 1200 x 1800mm | each | £172.84 |
| LNB84** | 1200 x 2400mm | each | £207.95 |

** Please specify colour when ordering, see swatch below



Non-returnable items, please report damages or discrepancies within 72 hours

A Contemporary Unframed Noticeboard

- Eye catching range of noticeboards in bright contemporary felt colour finishes
- A selection of 6 fabric colours: Cyan (CY), Lilac (LC), Magenta (MG), Orange (OR) Bright Green (BG) & Purple (PU)
- Designed for use with both pins and Velcro
- 3 largest sizes are supplied in 2 parts

| | | | |
|-----------|---------------|------|--------|
| UNC960** | 900 x 600mm | each | £25.78 |
| UNC1290** | 1200 x 1200mm | each | £34.07 |
| UNC1512** | 1500 x 1200mm | each | £53.22 |
| UNC1812** | 1800 x 1200mm | each | £67.15 |
| UNC2412** | 2400 x 1200mm | each | £67.53 |

** Please specify colour when ordering, see swatch at bottom of page



A

B Contemporary Framed Noticeboards

- Brighten up your school with these extra stylish noticeboards
- Available in 6 stylish felt options
- Made in the UK to the highest specification
- Accepts Velcro fasteners and pins
- 5 sizes available
- 2 largest sizes are supplied in 2 parts

| | | | |
|-----------|---------------|------|--------|
| CNB960** | 900 x 600mm | each | £31.38 |
| CNB1290** | 1200 x 900mm | each | £43.62 |
| CNB1512** | 1500 x 1200mm | each | £63.41 |
| CNB1812** | 1800 x 1200mm | each | £68.81 |
| CNB2412** | 2400 x 1200mm | each | £85.76 |

** Please specify colour when ordering, see swatch at bottom of page



B

C Contemporary Tamperproof Noticeboards

- Brighten up your school with these extra stylish noticeboards
- Available in 6 stylish felt options
- Made in the UK to the highest specification
- Accepts Velcro fasteners and pins
- 4 sizes available

1 Door

| | | | |
|-------------|---------------|------|---------|
| CTPNB960** | 900 x 600mm | each | £77.57 |
| CTPNB990** | 900 x 900mm | each | £103.87 |
| CTPNB1290** | 1200 x 900mm | each | £111.35 |
| CTPNB1812** | 1800 x 1200mm | each | £204.60 |

** Please specify colour when ordering, see swatch at bottom of page



C

Please Specify:
Felt/fabric colour

Contemporary Felt Colours

| | | | | | |
|--------|---------|-------|--------|------|--------------|
| | | | | | |
| Purple | Magenta | Lilac | Orange | Cyan | Bright Green |

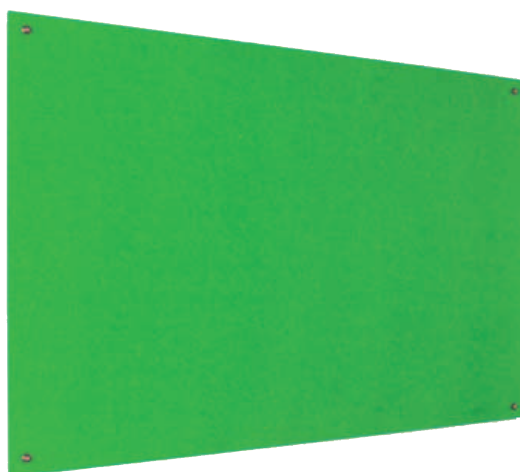

Fire Resistant

Please Specify:

Fabric colour

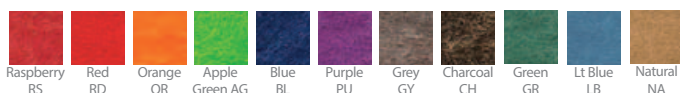

Frameless EcoColour® Noticeboards

A fantastic range of recycled noticeboards that are not only fire resistant but also have acoustic properties

- Fire Resistant to Class 0
- Made from recycled materials
- Acoustic properties up to NRC 0.8
- Self- coloured pinnable core
- Available in 11 different colours
- 3 largest sizes are supplied in 2 parts

| | | |
|-----------|-----------------|---------|
| DEUFB32* | W900 x H600mm | £28.23 |
| DEUFB43 * | W1200 x H900mm | £47.90 |
| DEUFB44 * | W1200 x H1200mm | £61.43 |
| DEUFB54 * | W1500 x H1200mm | £74.70 |
| DEUFB64 * | W1800 x H1200mm | £91.86 |
| DEUFB84 * | W2400 x H1200mm | £123.24 |

*Please specify colour when ordering



Fire Resistant

Please Specify:

Fabric colour

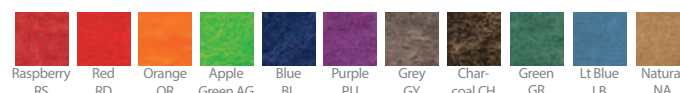

Aluminium Frame EcoColour® Noticeboards

A fantastic range of recycled noticeboards with aluminium frame that are not only fire resistant but also have acoustic properties

- Fire Resistant to Class 0
- Made from recycled materials
- Acoustic properties up to NRC 0.8
- Self- coloured pinnable core
- Available in 11 different colours

| | | |
|----------|-----------------|---------|
| DE22632* | W900 x H600mm | £38.37 |
| DE22643* | W1200 x H900mm | £68.54 |
| DE22644* | W1200 x H1200mm | £84.61 |
| DE22654* | W1500 x H1200mm | £100.97 |
| DE22664* | W1800 x H1200mm | £122.02 |
| DE22684* | W2400 x H1200mm | £151.38 |

* Please specify colour when ordering



Light Oak Effect Premium Aluminium Frame EcoColour® Tamperproof Noticeboard

Stunning light oak effect aluminium frame with EcoColour® recycled material which is not only fire resistant but also has acoustics properties.

- Fire resistant to Class 0
- Made from recycled material
- Acoustic properties up to NRC 0.8
- Attractive contour frame design
- Available in 11 different colours

Single Door

| | | |
|----------|-----------------|---------|
| DECBT32* | W600 x H900mm | £102.40 |
| DECBT43* | W900 x H1200mm | £143.97 |
| DECBT44* | W1200 x H1200mm | £171.01 |

Double Door

| | | |
|----------|-----------------|---------|
| DECBT64* | W1800 x H1200mm | £251.61 |
| DECBT84* | W2400 x H1200mm | £303.00 |

* Please specify colour when ordering

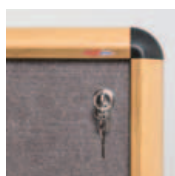

Please Specify:

Fabric colour

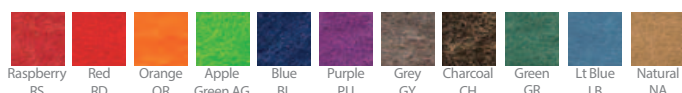

Top Hinged Tamperproof EcoColour® Fire Resistant Noticeboards

- Top hinged lockable noticeboards with door supports
- Ideal for use in busy corridors
- Doors open upwards and are kept in place with support stays
- 2 locks per doors with matching keys
- Range of 11 standard colours

Single door

| | | |
|----------|-----------------|---------|
| DE27301* | W900 x H600mm | £118.19 |
| DE27302* | W900 x H900mm | £145.97 |
| DE27303* | W900 x H1200mm | £157.93 |
| DE27305* | W1200 x H900mm | £157.81 |
| DE27304* | W1200 x H1200mm | £186.36 |

Double door

| | | |
|---------|-----------------|---------|
| DE2736* | W1800 x H900mm | £289.82 |
| DE2738* | W1800 x H1200mm | £313.47 |
| DE2737* | W2400 x H1200mm | £374.15 |

*Please specify colour when ordering.

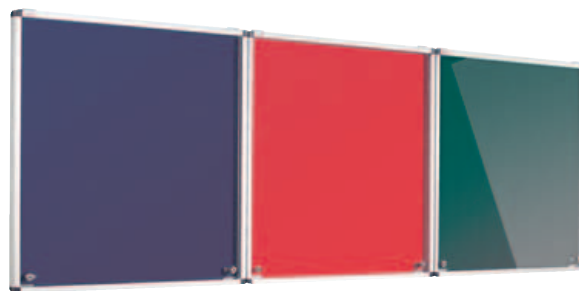

Please Specify:

Fabric colour

EcoColour® Resist-a-Flame® Range

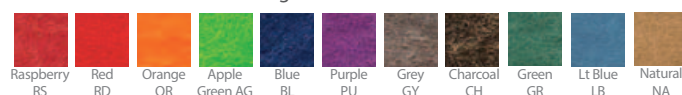

A

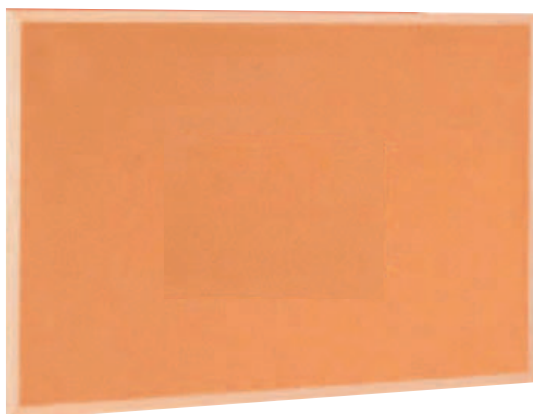

A Economy Cork Boards

- Lightweight double sided pin board
- Felt one side, cork on the other
- Supplied with fixings & free pins

| | | | |
|--------|-------------|------|--------|
| F04071 | 600 x 900mm | each | £13.85 |
|--------|-------------|------|--------|



B



B Premium Cork Boards with MDF Frame

- Thick resilient cork for everyday use

| | | | |
|-----------|---------------|------|--------|
| MDFCK96 | 900 x 600mm | each | £27.47 |
| MDFCK129 | 1200 x 900mm | each | £36.65 |
| MDFCK1812 | 1800 x 1200mm | each | £53.96 |
| MDFCK2412 | 2400 x 1200mm | each | £63.65 |

C

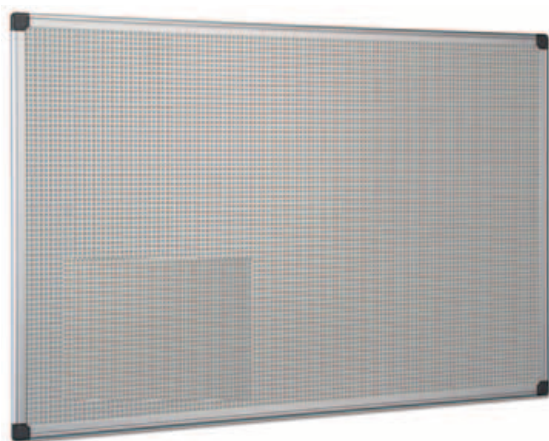

C Magnetic 'Pin Boards'

- Gridded metal over a grey cork notice board allows both pushpins, and magnets to be used
- Smart aluminium frame
- Hanging devices included
- Magnets and push pins included

| | | | |
|-------|--------------|------|--------|
| 42203 | 600 x 450mm | each | £39.57 |
| 42030 | 900 x 600mm | each | £57.93 |
| 42501 | 1200 x 900mm | each | £96.41 |



A Felt Noticeboards with Wooden MDF Frame

- Flame retardant felt to BS476 part 7 class 1
- All fabric is colourfast to BS1006
- Fixings pack included
- Available in Blue-BL Red-RD Green-GR Grey-GY Burgundy-BG

| | | | |
|------------|---------------|------|--------|
| MDFFB96* | 900 x 600mm | each | £31.72 |
| MDFFB129* | 1200 x 900mm | each | £44.67 |
| MDFFB1812* | 1800 x 1200mm | each | £72.10 |
| MDFFB2412* | 2400 x 1200mm | each | £96.01 |

*Please specify colour when ordering



A



Non-returnable items, please report damages or discrepancies within 72 hours

B Eco-Friendly Noticeboards

- Ever popular range offering an environmental choice at economical prices
- Almost entirely constructed from timber industry bi-products and recycled materials
- Attractive contoured 35mm wide frame is available in a choice of Light Oak (LO), Mahogany (MG) or Aluminium (AL) effect finishes
- Available in 5 popular felt colours: Blue (BL), Burgundy (BG), Green (GR), Grey (GY), Red (RD) or Traditional Cork (CK)
- Felt accepts both pins and Velcro®, cork option is pinnable

| | | |
|----------|---------------|--------|
| ECF96* | 900 x 600mm | £25.42 |
| ECF129* | 1200 x 900mm | £34.72 |
| ECF1212* | 1200 x 1200mm | £39.53 |
| ECF1512* | 1500 x 1200mm | £53.43 |
| ECF1812* | 1800 x 1200mm | £62.03 |
| ECF2412* | 2400 x 1200mm | £78.62 |

* Please specify frame type and board colour when ordering



B

Frame Options

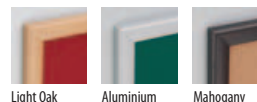

Please Specify:

1. Frame finish
2. Felt/fabric colour



CALL US ON 01527 878348



VISIT WWW.FORWARDPRODUCTS.CO.UK

A



A Cork/Drywipe Boards

- Lightweight dual purpose boards
- Half drywipe and half cork pinboard surface
- Supplied with drywipe pen and pins

| | | | |
|---------|-------------|------|--------|
| 23010BQ | 600 x 400mm | each | £5.86 |
| 27010BQ | 900 x 600mm | each | £10.83 |



B



B Duo Felt/Whiteboards

- Twin surface boards offer the flexibility of both a dry-wipe whiteboard and a pinnable surface felt or cork noticeboard
- Drywipe surface is magnetic
- Felt surface accepts Velcro® as well as pins - colour fast to BS1006
- Available in 5 standard felt colours - Blue (BL), Burgundy (BG), Green (GR), Grey (GY) or Red (RD)
- Attractive anodised aluminium trim with concealed corner fixings (supplied)
- Made in UK

| | | | |
|----------|---------------|------|--------|
| COMF32** | 900 x 600mm | each | £26.32 |
| COMF43** | 1200 x 900mm | each | £38.12 |
| COMF64** | 1800 x 1200mm | each | £65.76 |

** Please specify colour when ordering

C



C Snap Display Poster Frames

- Attractive anodised aluminium frame
- Use to display information and signs
- Quick and easy to fit
- Clear plastic cover protects contents

| | | | |
|-------|----|------|--------|
| SNFA4 | A4 | each | £13.91 |
| SNFA3 | A3 | each | £18.62 |
| SNFA2 | A2 | each | £20.88 |

D



D Photo & Certificate Frames

- Choose from smart black wooden frame or economical frameless version
- Non glass break resistant front
- Simple metal clips hold the contents in place, easy to open and insert display
- A4 black frame has back stand

| | | | |
|-----------|----------------|------|--------|
| F00400PHT | A4 Black Frame | each | £8.37 |
| F00402PHT | A3 Black Frame | each | £10.26 |



BusyFold® Light Display Kits

Lightweight folding panel system with 600 x 900mm PVC framed panels which are linked with flexible hinging and clip on top of each other.

- The 7 and 10 panel unit features triangular plinth/s for displaying 3D objects
- Double sided panels are covered in a choice of 14 loop nylon colours which are fire retardant to BS5867
- Accepts Velcro®
- All kits include headers and a carrying bag

** Please state frame and felt colour required
- frames available in grey or black

Non-returnable items, please report damages or discrepancies within 72 hours

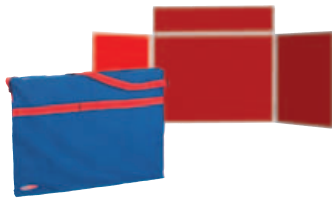

BusyFold Tabletop Landscape H x W

DBL3** 800 x 1800mm £76.10

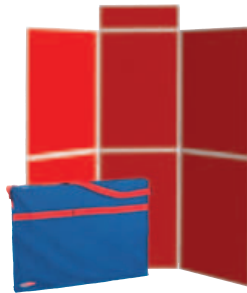

BusyFold 6 Kit H x W

DB6** 2000 x 1800mm £163.45

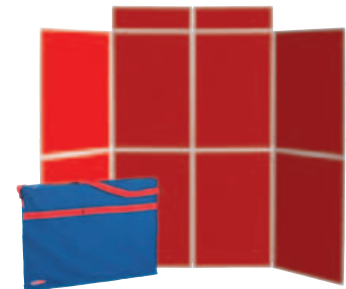

BusyFold 8 Kit H x W

DB8** 2000 x 2400mm £220.08

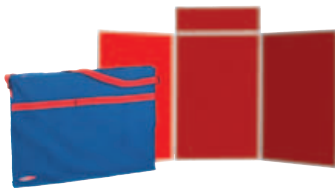

BusyFold Tabletop Portrait H x W

DB3P** 1100 x 1800mm £90.43

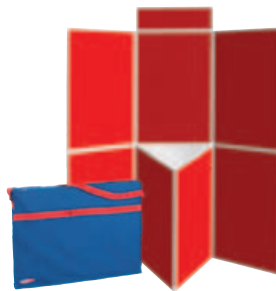

BusyFold 7 Kit H x W

DB7** 2000 x 1800mm £203.86

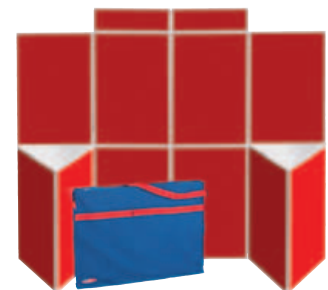

BusyFold 10 Kit H x W

DB10** 2000 x 2400mm £285.00

Please Specify:

Felt colour



Blue & Grey Royal Blue Emerald Alpha Red Light Blue Burgundy Black Yellow Orange Cyan Apple Purple Magenta Lilac



CALL US ON 01527 878348



VISIT WWW.FORWARDPRODUCTS.CO.UK

A



A Radio Controlled Clock

- Radio controlled office wall clock with a stylish metal case.
- 300mm diameter
- Brushed steel case with glass lens
- Keeps perfect time by itself. Never 'change the time' again!

| | | | |
|-----|------------------|------|--------|
| RWC | Radio Controlled | each | £17.71 |
|-----|------------------|------|--------|

B



B The Original Exam Clock

- Large 300mm clock
- 12/24hr
- Plastic case
- Arabic dial
- Takes 1 AA battery (not included)

| | | | |
|-----|------------|------|-------|
| EWC | Exam Clock | each | £9.22 |
|-----|------------|------|-------|

C



C Silver Office Wall Clock

- Stylish office wall clock in silver
- 250mm diameter
- Plastic case
- Glass lens
- Arabic dial
- Takes 2 AA batteries (not included)

| | | | |
|-----|-------------------|------|--------|
| OWC | Office Wall Clock | each | £12.08 |
|-----|-------------------|------|--------|



A Colourful Wall Clocks

- Battery not included (1 x AA battery required)
- 255mm diameter

| | | | |
|-------|-------|------|--------|
| 92301 | White | each | £13.21 |
| 92302 | Black | each | £13.21 |
| 92303 | Red | each | £13.21 |
| 92308 | Blue | each | £13.21 |



A

B Lockable Key Cabinets

- Features metal key hanger strips
- All steel construction available in grey finish
- Includes wall fixing kit, cylinder lock with two keys and key labelling strips

| | | | |
|-------|--------|------|--------|
| 32881 | 20 Key | each | £16.91 |
| 32883 | 48 Key | each | £22.22 |
| 32886 | 80 Key | each | £31.42 |



B

C First Aid Wall Cabinets

- Sturdy, lockable, first aid metal wall cabinets supplied with internal shelves, first aid sticker, wall fixing points and 2 keys
- Ideal for preventing pilfering of first aid kit
- These units are supplied empty

Single Door 50 x 30 x 12 cm

| | | |
|-------|------|--------|
| 11126 | each | £38.04 |
|-------|------|--------|

Double Door 60 x 50 x 12.5 cm

| | | |
|-------|------|--------|
| 11127 | each | £69.25 |
|-------|------|--------|



C

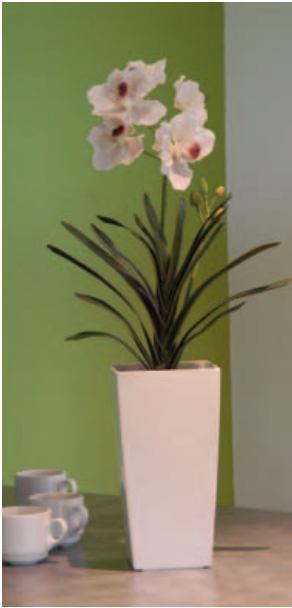

White Orchid



Greenaloe



Green Ficus



Yucca Rostrata



Heliconia



Indoor Plants

- Instantly enhance reception areas or offices with this great selection of lifelike plants
- No watering & no withering plants or dropping leaves

| | | |
|---------|------------------------------------|---------|
| R211111 | White Orchid - Maxi White - H600mm | £93.91 |
| R211116 | Greenaloe Scarlet - H1300 | £251.80 |
| R211117 | Green Ficus Black - H1900mm | £265.40 |
| R211118 | Yucca Rostrata Black - H1400mm | £265.40 |
| R211119 | Heliconia QR43 Black - H1800mm | £353.87 |





Buxus Ball



Entrance Spiral



Pyramid Buxus



Bay Ball - Silver



Yellow Pansy



Morning Glory - Window box

Outdoor Plants

- Bring life and vitality to your main entrance or carpark area without the hassle of attending to them

| | | |
|---------|--|---------|
| R211121 | Buxus Ball LE30 Black - H900mm | £251.80 |
| R211122 | Entrance Spiral - H1600mm | £326.65 |
| R211123 | Pyramid Buxus LE30 Black - H1200mm | £287.52 |
| R211126 | Bay Ball QR43 Silver - H1400mm | £265.40 |
| R211127 | Morning Glory Window Box PT2 - W1000mm | £125.90 |
| R211128 | Red Geranium Window Box PT1 - W1000mm | £167.86 |
| R211129 | Yellow Pansy MHB1 - D400mm | £93.91 |



Red Geranium - Window Box



CALL US ON 01527 878348



VISIT WWW.FORWARDPRODUCTS.CO.UK



7

Office Seating

| | |
|------------------------------|-------------|
| Operator Seating | 124-129 |
| Task Seating | 130-135 |
| Manager & Executive Seating | 136-137 |
| Backcare Seating | 138-139 |
| Conference Seating | 140-145,147 |
| Executive Conference Seating | 146 |



Harlech Chair

- A comfortable operator chair to help you feel supported throughout the day
- Height adjustable ratchet back
- Available with adjustable arms, seat slide and pump up lumbar support
- Popular fabric options shown below. Many other fabric options available, please see ranges and price details on pages 258-265

| | | |
|----------|-------------------------------|---------|
| T210251* | High Back Chair | £156.52 |
| T210252* | High Back Chair with Adj Arms | £175.33 |
| T210253 | Polished Aluminium Base | £30.85 |
| T210254 | Seat Slide | £21.82 |
| T210255 | Pump Up Lumbar Support | £21.82 |

* Please specify fabric colour



Please see Important Furniture Ordering Information on page 3 before placing your furniture order

Popular Fabric Colour Options Standard Fabric - Advantage



Charcoal Clipper Wine Aqua Purple

Premium Fabric – Aquarius (add 35% to prices)



Rhino Purple Tombola Pascal Poison

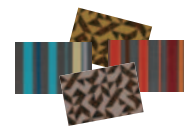

See pages 258-265 for further fabric options



Miranda Mesh Back Operator Chair

- Deep cushioned seat for extra comfort with a mesh back
- Free-float ride quality allows the chair to follow your movement or have the adjustment fixed in a position to suit you!
- Available with adjustable arms
- 5 Year Guarantee
- Mesh back available in Blue, Black, Green, Orange, Red or White - please specify when ordering
- Popular fabric options shown on previous page. Many other fabric options available, please see ranges and price details on pages 258-265



| | | |
|----------|--|---------|
| T210271* | Miranda Mesh Back | £175.60 |
| T210272* | Miranda Mesh Back with Adjustable Arms | £212.12 |
| T210273 | Polished Aluminium Base | £31.61 |
| T210274 | Seat Slide | £25.64 |

* Please specify mesh colour and fabric colour



Now available in anti-microbial woven fabric, effective against Covid-19 see page 262

Please see Important Furniture Ordering Information on page 3 before placing your furniture order





Carlisle Chair

- Great support with large waterfall-front seat and well cushioned back
- UK fire retardant foam and tough-wearing fabric
- 1 year guarantee
- Adjustable, fixed or floating back setting
- Available in Havana and Scuba fabrics only

| | | 1-2 | 3+ |
|----------|--------------------------------------|---------|--------|
| T211171* | Carlisle Medium Back | £87.10 | £73.45 |
| T211172* | Carlisle High Back | £90.25 | £76.91 |
| T211174* | Carlisle Medium Back with Fixed Arms | £108.08 | £92.96 |
| T211175* | Carlisle High Back with Fixed Arms | £109.20 | £93.52 |

* Please specify fabric colour

Fabric Colour Options



Havana Scuba

Perfect for ICT and Office Environments

Please see Important Furniture Ordering Information on page 3 before placing your furniture order

5 YEAR GUARANTEE

Whitley Chair

- Smart looking operator chair that compliments any office or classroom
- Deep upholstery for comfort and support
- Ratchet back height adjustment
- 5 year guarantee
- Popular fabric options shown below. Many other fabric options available, please see ranges and price details on pages 258-265

| | | |
|----------|-------------------------|---------|
| T210181* | Whitley High Back | £153.88 |
| T210182* | Whitley with Fixed Arms | £179.08 |
| T210183* | Whitley with Adj. Arms | £186.04 |
| T210184 | Polished Aluminium Base | £30.16 |
| T210185 | Seat Slide | £25.64 |
| T210186 | Pump Up Lumbar Support | £27.97 |

* Please specify fabric colour



Whitley Chair

Fixed Arms

Adjustable Arms & Aluminium Base

Popular Fabric Colour Options

Standard Fabric - Advantage



Charcoal

Clipper

Wine

Aqua

Purple

Premium Fabric – Aquarius (add 35% to prices)



Rhino

Purple

Tombola

Pascal

Poison

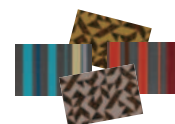

See pages 258-265 for further fabric options



Vaneto Chair

- Comfortable, durable and inexpensive range of quality task chairs
- Twin lever mechanism for easy adjustments
- Available in medium and high back options
- 5 year guarantee
- Popular fabric options shown on previous page. Many other fabric options available, please see ranges and price details on pages 258-265

| | | |
|----------|---|---------|
| T210191* | Vaneto Medium Back | £99.98 |
| T210192* | Vaneto Medium Back with Fixed Arms | £116.48 |
| T210193* | Vaneto Medium Back with Adjustable Arms | £132.14 |
| T210194* | Vaneto High Back | £109.54 |
| T210195* | Vaneto High Back with Fixed Arms | £126.06 |
| T210196* | Vaneto High Back with Adjustable Arms | £141.70 |
| T210197 | Polished Aluminium Base | £30.16 |
| T210198 | Seat Slide | £23.15 |
| T210199 | Pump Up Lumbar Support | £25.25 |

* Please specify fabric colour



High Back & Fixed Arms



Medium Back



Medium Back & Fixed Arms



Medium Back & Adjustable Arms



High Back



High Back, Adjustable Arms & Aluminium Base

Now available in anti-microbial woven fabric, effective against Covid-19 see page 262





5 YEAR
GUARANTEE

Helmsley Chair

- Ergonomic operator chair
- Sculptured seat and back for greater comfort
- 2 lever mechanism
- Hand wheel back height adjustment
- 5 year guarantee
- Seat height 450 - 480mm, width 480mm, depth 450mm
- Popular fabric options shown on next page. Many other fabric options available, please see ranges and price details on pages 258-265

| | | |
|----------|---|---------|
| T211221* | High Back Operator Chair | £151.09 |
| T211222* | High Back Operator Chair with Fixed Arms | £173.24 |
| T211223* | High Back Operator Chair with Adjustable Arms | £186.26 |

* Please specify fabric colour

Please see Important Furniture Ordering Information on page 3 before placing your furniture order

Toledo Ergonomic Chair

- An ergonomic chair for users with back pain, or for those who require an extra degree of comfort
- Triple lever mechanism with adjustable tension control
- Superior, free float ride quality and the facility to independently set the seat and back angle – great for stiff backs and aching joints
- Large, deep cushioned seat & back
- Ratchet back height adjustment
- 5 year guarantee
- Popular fabric options shown on next page. Many other fabric options available, please see ranges and price details on pages 258-265

5 YEAR
GUARANTEE



High Back



Fixed Arms & Aluminium Base



Adjustable Arms

| | | |
|----------|---------------------------------------|---------|
| T210231* | Toledo High Back | £167.78 |
| T210232* | Toledo High Back with Fixed Arms | £193.00 |
| T210233* | Toledo High Back with Adjustable Arms | £199.96 |
| T210234 | Polished Aluminium Base | £32.87 |
| T210235 | Seat Slide | £25.64 |
| T210236 | Pump Up Lumbar Support | £27.97 |

* Please specify fabric colour



Fyvie Chair

- Superior operator chair range for the discerning buyer
- Large and deep cushioned seat
- 2 lever mechanism
- Oval sculptured back for increased comfort
- Optional aluminium base
- Matching visitor chairs
- Visitor chairs have 25mm steel cantilever frame
- Seat height 470 - 600mm, width 455mm depth 440mm
- Popular fabric options shown below. Many other fabric options available, please see ranges and price details on pages 258-265

| | | |
|----------|--------------------------------|---------|
| T211241* | Fyvie Operator Chair | £128.45 |
| T211242* | Fyvie with Fixed Arms | £154.20 |
| T211243* | Fyvie with Adjustable Arms | £163.49 |
| T211244 | Polished Aluminium Base | £32.71 |
| T211245* | Fyvie Visitor Chair | £139.61 |
| T211246* | Visitor Chair with Fixed Arms | £162.97 |
| T211247 | Chrome Frame for Visitor Chair | £30.37 |

* Please specify fabric colour

 Now available in anti-microbial woven fabric, effective against Covid-19 see page 262



Operator Chair



Adjustable Arms & Aluminium Base

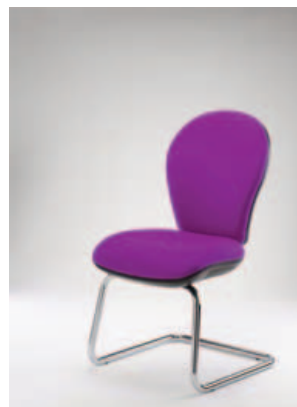

Visitor Chair Chrome Frame



Visitor Chair with Arms, Chrome Frame

Popular Fabric Colour Options
Standard Fabric - Advantage



Charcoal Clipper Wine Aqua Purple

Premium Fabric – Aquarius (add 35% to prices)



Rhino Purple Tombola Pascal Poison

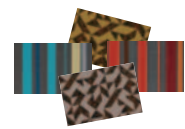

See pages 258-265 for further fabric options



CALL US ON 01527 878348



VISIT WWW.FORWARDPRODUCTS.CO.UK



Now available in anti-microbial woven fabric, effective against Covid-19 see page 262

Atlanta Ergonomic Task Chair

- Heavy duty ergonomic task chair for 24hrs/day use
- Inflatable lumbar support and extra-large, cushioned seat and back for maximum comfort
- Available with adjustable arms
- Ratchet back height adjustment
- With adjustable tension control
- Popular fabric options shown on next page. Many other fabric options available, please see ranges and price details on pages 258-265

| | | |
|----------|--|---------|
| T210281* | Atlanta Ergonomic | £297.32 |
| T210282* | Atlanta Ergonomic with Adjustable Arms | £342.54 |
| T210283 | Polished Aluminium Base | £31.61 |
| T210284 | Seat Slide | £25.64 |
| T210285 | Pump Up Lumbar Support | £27.97 |

* Please specify fabric colour

Please see Important Furniture Ordering Information on page 3 before placing your furniture order

Castelo Mesh Back Task Chair

- Black mesh back
- Ratchet back height adjustment
- Lumbar support back
- Available with adjustable arms
- 5 year guarantee
- Popular fabric options shown on next page. Many other fabric options available, please see ranges and price details on pages 258-265

| | | |
|----------|--|---------|
| T210291* | Castelo Mesh Back | £252.98 |
| T210292* | Castelo Mesh Back with Adjustable Arms | £292.98 |
| T210293* | Castelo Mesh Back with Synchro Mechanism | £273.86 |
| T210294* | Castelo Mesh Back with Synchro Mechanism & Adj. Arms | £313.84 |
| T210295 | Polished Aluminium Base | £36.12 |
| T210296 | Seat Slide | £27.72 |

* Please specify fabric colour



5 YEAR GUARANTEE



Please see Important Furniture Ordering Information on page 3 before placing your furniture order



Lift back 7 increments to desired height, 8th position returns back to lowest setting

Lift arm by lifting lever under the arm and adjusting to suit

Pump up lumbar support to a comfortable inflation and release with push button

Lift lever to adjust sliding seat, release to lock in position (left lever)

Lift levers to release back synchronised mechanism. Back and seat are now in free float. Push levers down to lock in position.

Turn to adjust tension depending upon operator's weight

Lift and hold lever to operate gas height adjustment. Set to desired height and release. (Front Lever)



Stokesay Chair

- Brilliant value for money task chair
- Highly ergonomic with contoured seat and back
- Synchronised or independent mechanism - synchronised moves seat and back together, independent mechanism adjusts them separately
- Pump up lumbar support
- Ratchet back height adjustment
- 5 year guarantee
- Seat height 500-600mm, width 510mm, depth 480mm
- Popular fabric options shown below. Many other fabric options available, please see ranges and price details on pages 258-265



| | | |
|----------|------------------------------|---------|
| T211311* | With Black Base | £244.05 |
| T211312* | With Black Base & Adj. Arms | £281.03 |
| T211313* | With Chrome Base | £281.03 |
| T211314* | With Chrome Base & Adj. Arms | £329.10 |

* Please specify fabric colour
 **Please choose synchronised or independent mechanism

Popular Fabric Colour Options
 Standard Fabric - Advantage

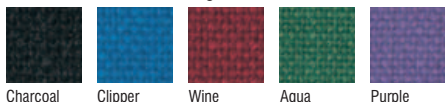

Premium Fabric – Aquarius (add 35% to prices)

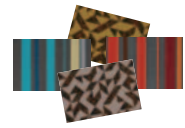
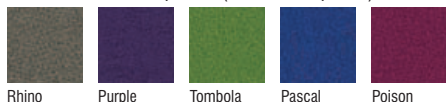

See pages 258-265 for further fabric options



Wentworth

- Sophisticated technical mesh back
- Weight responsive self-adjusting synchronised mechanism
- Antishock back tilt locking system (4 Positions)
- CMHR Moulded seat foam
- 685mm polished aluminium or black nylon 5 star base
- 60mm twin hard wheeled black castors
- Height adjustable lumbar support
- 50mm Sliding seat depth adjustment
- Popular fabric options shown below. Many other fabric options available, please see ranges and price details on pages 258-265
- **Please see Important Furniture Ordering Information on page 3 before placing your furniture order**

| | | |
|----------|------------------------|---------|
| T211321* | Mesh Task Chair | £267.57 |
| T211322* | Mesh Draughtsman Chair | £338.27 |
| T211323* | Mesh Cantilever Chair | £249.51 |

* Please specify fabric colour

Additional Options

| | | |
|---------|--|--------|
| T211325 | 1D Arms (Height Adj) | £34.31 |
| T211326 | 3D Arms (Height, Depth & 30° Rotation Adj) | £56.85 |
| T211327 | Polished Aluminium Base | £35.01 |
| T211328 | Contrasting Side Panel | £13.87 |
| T211329 | Chrome Frame | £23.39 |

Arm Options



1D Arm



3D Arm

Base Options



PB Base



CF Frame

User Controls

Wentworth's design is clean, crisp and uncluttered. All of the user controls are well arranged and located within easy ergonomic reach of the user.

- 1 Seat height adjustment.
- 2 Backrest tilt.
- 3 Seat slide adjustment.
- 4 Armrest height adjustment.
- 5 Height adjustable lumbar support.



Now available in anti-microbial woven fabric, effective against Covid-19 see page 262

Popular Fabric Colour Options

Standard Fabric - Advantage

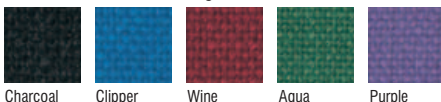

Charcoal

Clipper

Wine

Aqua

Purple

Premium Fabric – Aquarius (add 35% to prices)



Rhino

Purple

Tombola

Pascal

Poison

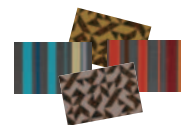

See pages 258-265 for further fabric options



Rochester Chair

- High back executive style chair at incredible value
- Superb back support
- Pump up lumbar support
- Adjustable seat and back angle
- Height adjustable arms and headrest available
- Available with chrome base and arms POA
- 5 year guarantee
- Seat height 480 - 640mm, width 530mm, depth 500mm
- Popular fabric options shown on previous page. Many other fabric options available, please see ranges and price details on pages 258-265

| | | |
|----------|---|---------|
| T211341* | Rochester Chair No Arms | £263.78 |
| T211342* | Rochester Chair with Adjustable Arms | £329.10 |
| T211343* | Rochester Chair with Headrest + Adjustable Arms | £409.22 |

* Please specify fabric colour

Please see Important Furniture Ordering Information on page 3 before placing your furniture order



Penrith Chair

- Executive task chair with cushioned rolled seat and double curvature back
- Synchronised mechanism
- Style base in black or chrome
- Height adjustable back
- Medium back chair also available, please call for details
- Popular fabric options shown on previous page. Many other fabric options available, please see ranges and price details on pages 258-265

| | | |
|----------|------------------------------------|---------|
| T211351* | With Black Style Base | £327.26 |
| T211352* | With Black Style Base - Adj. Arms | £387.11 |
| T211353* | With Chrome Style Base | £374.36 |
| T211354* | With Chrome Style Base - Adj. Arms | £432.95 |
| T211355 | Seat Slide | £29.96 |
| T211356 | Lumbar Support | £29.96 |

* Please specify fabric colour





Excel Cantilever Chair has a Chrome Frame as Standard



Stylish Curved Mesh Back



Back Lumbar Support - Adjustable from a Seated Position

Excel Mesh Back Chairs

- Enjoy stunning looks and high levels of comfort with this new mesh back range
- Optional unique lumbar support on task chair allows operator to adjust the lumbar support from a seated position
- 5 year guarantee
- **Please see Important Furniture Ordering Information on page 3 before placing your furniture order**



Excel Mesh Back Task Chair

- Seat slide as standard
- Popular fabric options shown on next page. Many other fabric options available, please see ranges and price details on pages 258-265

| | | |
|----------|------------------------------------|---------|
| T211361* | Mesh Back Chair | £324.35 |
| T211362* | Mesh Back Chair - Adjustable Arms | £367.68 |
| T211363 | Optional Polished Base | £38.08 |
| T211365 | Optional Soft Tyre Castors | £27.58 |
| T211366 | Optional Adjustable Lumbar Support | £32.83 |

* Please specify fabric colour

Excel Mesh Back Cantilever Chair

- Polished chrome frame
- Black mesh back as standard
- Popular fabric options shown on next page. Many other fabric options available, please see ranges and price details on pages 258-265

| | | |
|----------|--------------------------|---------|
| T211792* | Cantilever Chair | £315.15 |
| T211794 | Optional Grey Mesh Back | £19.73 |
| T211795 | Optional White Mesh Back | £19.73 |

* Please specify fabric colour





Excel Task Chair

- Beautiful and high quality task chair
- Unique stepped back design and waterfall seat
- Style pedestal type base as standard
- Seat slide as standard
- Optional adjustable arms are specially angled to allow for ease of use when typing
- 5 year guarantee
- Popular fabric options shown below. Many other fabric options available, please see ranges and price details on pages 258-265
- **Please see Important Furniture Ordering Information on page 3 before placing your furniture order**



See pages 258-265 for fabric colour options

Excel Optional Features

| | | |
|----------|--------------------------------------|---------|
| T211383* | High Back Chair | £287.58 |
| T211384* | High Back Chair with Adjustable Arms | £330.91 |

| | | |
|---------|-------------------|--------|
| T211391 | Polished Base | £38.08 |
| T211393 | Soft Tyre Castors | £27.58 |
| T211394 | Pump Up Lumbar | £32.83 |

* Please specify fabric colour

Popular Fabric Colour Options

Standard Fabric - Advantage

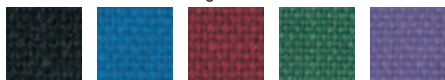

Charcoal Clipper Wine Aqua Purple

Premium Fabric – Aquarius (add 35% to prices)



Rhino Purple Tombola Pascal Poison

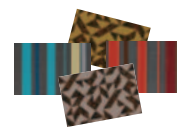

See pages 258-265 for further fabric options



CALL US ON 01527 878348



VISIT WWW.FORWARDPRODUCTS.CO.UK

Giovanni Executive Chair

- Premium managers task chair with inflatable lumbar support
- Set the chair up how you like for maximum comfort with its operator plus mechanism and multi-adjustable headrest and arms
- Ratchet back height adjustment
- 5 year guarantee
- Popular fabric and vinyl options shown below. Many other fabric options available, please see ranges and price details on pages 258-265



T210411* Giovanni with Adj. Arms £462.51

* Please specify fabric colour

 Now available in anti-microbial woven fabric, effective against Covid-19 see page 262



Elegance Executive Chair

- Classy executive managers chair with stylish looks and superb comfort
- Set the chair up for you with inflatable lumbar support, back height adjustment, a seat slider and adjustable arms
- 5 year guarantee
- Popular fabric and vinyl options shown below. Many other fabric options available, please see ranges and price details on pages 258-265

T210421* Elegence with Adj. Arms £431.32

* Please specify fabric colour

Popular Fabric Colour Options
Standard Fabric - Advantage

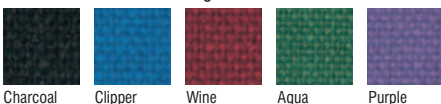

Anti-microbial Just Colour Vinyl (add 15% to prices)

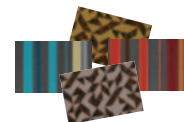

See pages 258-265 for further fabric options



Conquest Chair

- A generously cushioned high back executive armchair with pronounced head rest and attractive stitching detail
- Soft Black leather
- Matching padded black arms

| | | |
|---------|----------------|---------|
| T211441 | Conquest Chair | £197.61 |
|---------|----------------|---------|



Please see Important Furniture Ordering Information on page 3 before placing your furniture order

Balmoral Chair

- Soft bonded leather finish
- Twin lever heavy duty mechanism
- Aluminium base and arm rest
- Classy ribbed design
- Available in black or ivory
- Matching cantilever visitors chair

| | | |
|---------|------------------------|---------|
| T211481 | Black Chair | £313.63 |
| T211482 | Ivory Chair | £313.63 |
| T211483 | Black Cantilever Chair | £276.95 |
| T211484 | Ivory Cantilever Chair | £276.95 |



Dual layer Reflexion heat reactive foam for correct degree of back support and ultimate long term comfort

Dual layer Reflexion heat reactive seat foam for pressure relieving body support
The seat has 65mm of horizontal travel for correct support behind the knees

Stockholm Posture Chair

The Stockholm back care chair has been tested to the rigorous strength and stability standard, BS5459 and is guaranteed structurally for 5 years whilst in 24 hour per day use by persons weighing up to 150kg.

The back and seat recline together in a fixed 2:1 ratio. The tension of the recline is adjusted by a rotating handwheel. The recline function can be left unlocked in dynamic freefloat mode. For added comfort the back angle is independently adjustable

Inflatable lumbar support for individually tailored, "S" shaped spinal curve

Back height is adjustable for precise positioning of lumbar support

Synchro Plus with 6 adjustable functions to allow all users to achieve healthy and comfortable set up

Gas lift suitable for 150Kg user weight



Now available in anti-microbial woven fabric, effective against Covid-19 see page 262

- Reflexion, heat reactive memory foam in seat and back
- Seat slider and inflatable lumbar support
- Synchro Plus mechanism with tension adjustment and anti-kick safety feature
- Easy to use ratchet back height adjustment
- 4-way multifunctional, fully adjustable arms with ergonomically shaped, soft polyurethane pads
- Multi adjustable neck and head support
- Seat height 480 - 610mm, width 505mm, depth 470mm
- Popular fabric options shown on next page. Many other fabric options available, please see ranges and price details on pages 258-265



| | | |
|----------|---|---------|
| T211521* | Stockholm Chair | £632.98 |
| T211522* | Stockholm Chair with Arms | £703.15 |
| T211523* | Stockholm Chair with Adjustable Headrest | £707.83 |
| T211524* | Stockholm Chair with Adjustable Headrest and Arms | £786.62 |
| T211525 | Chrome Base | £41.91 |

* Please specify fabric colour



Trebuchet Posture Chair

- Very popular back care task chair
- Superior pelvic and spinal support
- Distinctive height adjustable shaped arms
- Black base as standard, polished metal base available POA
- Inflatable lumbar support as standard
- Popular fabric options shown below. Many other fabric options available, please see ranges and price details on pages 258-265



| | | |
|----------|-------------------------|---------|
| T211531* | Medium Back | £449.47 |
| T211532* | High Back | £499.39 |
| T211533* | High Back with Headrest | £572.00 |

* Please specify fabric colour

Please see Important Furniture Ordering Information on page 3 before placing your furniture order



Imperial Posture Chair

- The ultimate in back support and cushioning
- Ergonomically shaped back with body tension adjustment
- Independent mechanism and seat slide come as standard
- Option for height and depth adjustable headrest
- Height adjustable arms with gel inserts
- Popular fabric options shown below. Many other fabric options available, please see ranges and price details on pages 258-265

| | | |
|----------|---------------------------|---------|
| T211541* | Medium Back | £699.77 |
| T211542* | Medium Back with Headrest | £773.37 |
| T211543* | High Back | £745.33 |
| T211544* | High Back with Headrest | £815.42 |

* Please specify fabric colour

Popular Fabric Colour Options
Standard Fabric - Advantage

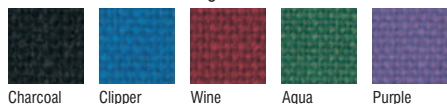

Charcoal Clipper Wine Aqua Purple

Premium Fabric – Aquarius (add 35% to prices)



Rhino Purple Tombola Pascal Poison

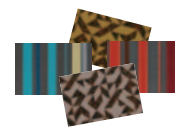

See pages 258-265 for further fabric options



CALL US ON 01527 878348



VISIT WWW.FORWARDPRODUCTS.CO.UK

Vita Skid Base Chair

- This stackable chair is the perfect solution for hospitality, education and commercial environments
- Sturdy polypropylene-fibreglass seat and back with additional comfort foam
- 5 year guarantee
- Popular fabric options shown below. Many other fabric options available, please see ranges and price details on pages 258-265



T210681* Vita Skid Base Chair £138.64

* Please specify fabric colour

Please see Important Furniture Ordering Information on page 3 before placing your furniture order



Catania Chair

- Sleek conference chair with square shaped back
- Robust and durable construction
- Standard frames stack up to four high (cantilever frame non-stacking)
- Silver frame (chrome also available POA)
- 5 year guarantee
- Popular fabric options shown below. Many other fabric options available, please see ranges and price details on pages 258-265



T211721* Side Chair £99.36

T211722* Cantilever Chair £97.25

* Please specify fabric colour

Popular Fabric Colour Options Standard Fabric - Advantage

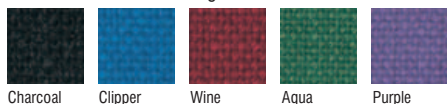

Premium Fabric – Aquarius (add 35% to prices)

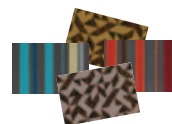

See pages 258-265 for further fabric options



Venice Chair

- Stackable conference chair
- Modern shaped back and deep padded seat
- Durable chrome frame as standard
- 5 year guarantee
- Popular fabric options shown on previous page.
Many other fabric options available, please see ranges and price details on pages 258-265

| | | |
|----------|--|---------|
| T211731* | 4 Leg Chair | £105.66 |
| T211732* | Cantilever Chair - Upholstered Back | £172.50 |

* Please specify fabric colour



Please see Important Furniture Ordering Information on page 3 before placing your furniture order

Now available in anti-microbial woven fabric, effective against Covid-19 see page 262

See pages 204-215 for our range of meeting tables

Verona Chair

- Exceedingly comfortable visitors chair
- Waterfall shaped seat and rolled back styling
- Generously proportioned padding
- Stackable
- 5 year guarantee
- Popular fabric options shown on previous page.
Many other fabric options available, please see ranges and price details on pages 258-265

| | | |
|----------|-----------------|---------|
| T211741* | Chair | £124.42 |
| T211742* | Chair with Arms | £149.43 |

* Please specify fabric colour





Valencia Banquet Chair

- Stylish chair for any occasion
- Black frame as standard
- Stack up to 10 high
- Seat height 470mm, seat width 455mm
- 15 year frame guarantee
- Linking option - please ask for details
- Popular fabric options shown below. Many other fabric options available, please see ranges and price details on pages 258-265

T211621* Valencia Banquet Chair £56.03

* Please specify fabric colour

15 YEAR
FRAME
GUARANTEE

Please see Important Furniture Ordering Information on page 3 before placing your furniture order

Vigo Stacking Chair

- Black welded frame
- Excellent value for money
- Stack up to 5 high
- Seat height 495mm, seat width 495mm
- 15 year frame guarantee
- Popular fabric options shown below. Many other fabric options available, please see ranges and price details on pages 258-265

T211631* Vigo Chair £53.77

T211632* Vigo with Arms £80.66

* Please specify fabric colour



+ Now available in anti-microbial woven fabric, effective against Covid-19 see page 262

Popular Fabric Colour Options
Standard Fabric - Advantage

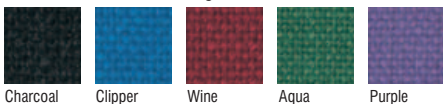

Charcoal

Clipper

Wine

Aqua

Purple

Premium Fabric – Aquarius (add 35% to prices)



Rhino

Purple

Tombola

Pascal

Poison

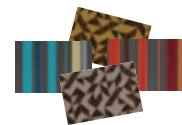

See pages 258-265 for further fabric options



Sevilla Chair

- A collection of multipurpose stacking chairs suitable for conference, meeting and training rooms, public waiting areas, canteens and schools
- Features include comfortable deep foam, three dimensional waterfall seat, plastic feet to eliminate floor scratching with a choice of black or chrome steel frames
- Stackable up to eight high
- Available with a fold-down writing tablet for training rooms
- Seat height 440mm, width 535mm
- Popular fabric options shown below. Many other fabric options available, please call for prices

| | | 1-9 | 10+ |
|----------|----------------------------|--------|--------|
| T211651* | Sevilla Chair | £52.06 | £46.98 |
| T211653* | Sevilla Chrome Chair | £52.85 | £47.68 |
| T211656 | Sevilla Canteen Side Chair | £50.70 | £48.00 |

* Please specify fabric colour



T211651



T211653



T211656

Sevilla Chair Fabric Options

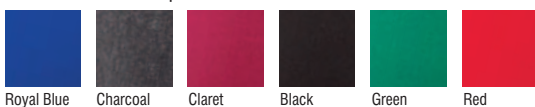

Royal Blue

Charcoal

Claret

Black

Green

Red

Please see Important Furniture Ordering Information on page 3 before placing your furniture order



CALL US ON 01527 878348



VISIT WWW.FORWARDPRODUCTS.CO.UK

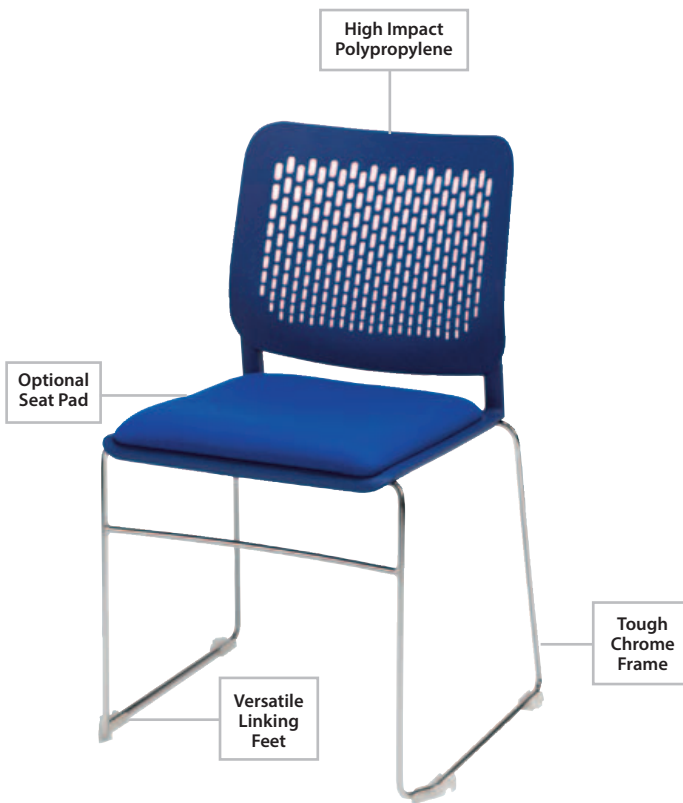

Abele Chair

- Durable multipurpose side chair
- Stackable: 25 un-upholstered, 12 upholstered
- Chrome frame
- Cantilever chairs have integral link
- Chrome chair trolley with lockable castors available
- Chairs also available with arms - POA
- Choice of 7 colours of plastic seat and back: Red, Blue, Black, White, Green, Brown and Grey
- Popular fabric options shown below. Many other fabric options available, please see ranges and price details on pages 258-265
- **Please see Important Furniture Ordering Information on page 3 before placing your furniture order**

| | | |
|----------|---------------------------------|---------|
| T211811* | Cantilever | £99.97 |
| T211812* | Cantilever with Seatpad | £123.73 |
| T211813* | Cantilever with Seat & Back Pad | £140.05 |
| T211814* | 4 Leg | £95.66 |
| T211815* | 4 Leg with Seatpad | £119.42 |
| T211816* | 4 Leg with Seat and Back Pad | £136.30 |
| T211817 | Chair Trolley | £198.82 |

* Please specify fabric and shell colour



+ Now available in anti-microbial woven fabric, effective against Covid-19 see page 262



Please Specify:

1. Chair colour
2. Seat and back colours

Shell Colour Options



Popular Fabric Colour Options

Standard Fabric - Advantage

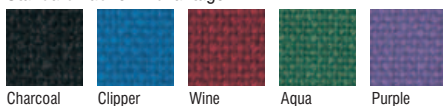

Premium Fabric – Aquarius (add 35% to prices)

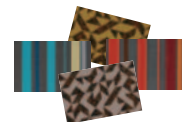

See pages 258-265 for further fabric options





Bianca Chair

- Superior mesh back
- Comfortably padded moulded seat
- Hardwearing chrome frame as standard
- Distinctive curved back and shaped legs
- 5 year guarantee
- Black mesh back as standard, coloured mesh also available, please call for price
- Popular fabric options shown below. Many other fabric options available, please see ranges and price details on pages 258-265
- **Please see Important Furniture Ordering Information on page 3 before placing your furniture order**

| | | |
|----------|------------------|---------|
| T211821* | 4 Leg Chair | £188.30 |
| T211822* | Cantilever Chair | £202.66 |

* Please specify fabric colour

Modena Chair

- Stylish mesh back training and conference chair
- Mesh back available in 11 colours
- Stackable
- Chrome frame as standard
- 5 year guarantee
- Please specify mesh back colour
- Popular fabric options shown below. Many other fabric options available, please see ranges and price details on pages 258-265
- **Please see Important Furniture Ordering Information on page 3 before placing your furniture order**

| | | |
|----------|-----------------------|---------|
| T211761* | 4 Leg Chair | £126.71 |
| T211762* | 4 Leg Chair with Arms | £164.33 |
| T211763* | Cantilever Chair | £187.47 |

* Please specify fabric colour and mesh back colour



Please Specify:

1. Mesh back colour
2. Fabric

Mesh back colour options - Black is standard, all other colours POA

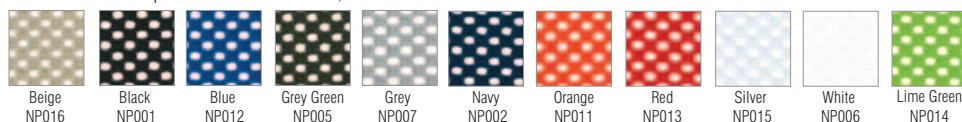

Popular Fabric Colour Options

Standard Fabric - Advantage



Premium Fabric – Aquarius (add 35% to prices)

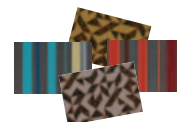

See pages 258-265 for further fabric options



CALL US ON 01527 878348



VISIT WWW.FORWARDPRODUCTS.CO.UK



Abingdon Chair

- Ideal chair for any conference or breakout area
- Soft, upholstered seat and back rest
- Solid wood armrest pads
- Chair linking available
- Wooden, folding writing top also available
- Black leather upholstery

| | | |
|---------|----------------|---------|
| T211891 | Abingdon Chair | £133.29 |
|---------|----------------|---------|

Please see Important Furniture Ordering Information on page 3 before placing your furniture order

Ascott Chair

- Classic executive conference chair
- Chrome cantilever frame
- Wide, comfortable seat and backrest
- Soft, natural leather upholstered armrests
- Natural split leather faced - Black

| | | |
|---------|--------------|---------|
| T211911 | Ascott Chair | £230.64 |
|---------|--------------|---------|



Brodsworth Chair

- Slimline and practical leather conference chair
- Chrome frame
- Size: W450 x D430 x H470mm
- Comfortable soft black leather upholstery

| | | |
|---------|------------------|---------|
| T211931 | Brodsworth Chair | £147.18 |
|---------|------------------|---------|



Abingdon Visitor Chair

- Extra-large, deep cushioned chair for maximum comfort
- Durable, wooden frame with antibacterial lacquer
- 5 year guarantee
- Popular fabric options shown below. Many other fabric options available, please see ranges and price details on pages 258-265

| | | |
|----------|-----------------------|---------|
| T212571* | Medium Back | £260.93 |
| T212572* | Medium Back With Arms | £290.59 |
| T212573* | High Back | £282.22 |
| T212574* | High Back With Arms | £311.89 |

* Please specify fabric colour

 Now available in anti-microbial woven fabric, effective against Covid-19 see page 262



Lorenzo Wood Framed Chair

- Durable, wooden frame with antibacterial lacquer
- Stackable 4 high
- 5 year guarantee
- Popular fabric options shown below. Many other fabric options available, please see ranges and price details on pages 258-265

| | | |
|----------|---------------------|---------|
| T212561* | Stacking Side Chair | £140.72 |
| T212562* | Arm Chair | £140.72 |

* Please specify fabric colour



Popular Colour Options
Main Line Plus Fabric

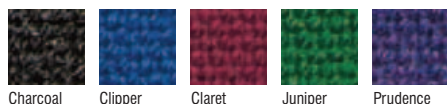

Anti-microbial Just Colour Vinyl (add 15% to prices)

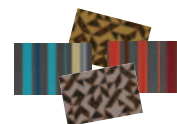

See pages 258-265 for further fabric options



CALL US ON 01527 878348



VISIT WWW.FORWARDPRODUCTS.CO.UK



8

Soft Seating

| | |
|-----------------|------------------|
| Modular Seating | 150-153 |
| Visitor Seating | 154-155 |
| Easy Seating | 156-157, 160-166 |
| Tub Chairs | 156, 158-159 |
| Bean Bags | 167 |



Now available in anti-microbial woven fabric, effective against Covid-19 see page 262



S210636
W480 x D440 x SH400/440mm

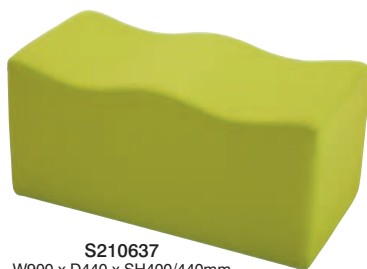

S210637
W900 x D440 x SH400/440mm



S210638
W1350 x D440 x SH400/440mm

Gravity Modular Stool

- A wide range of upholstered stools that work just as well on their own or joined to other stools
- Make each space unique with different stools joined together
- Available in a wide range of shapes and sizes
- Popular fabric options shown on next page. Many other fabric options available, please see ranges and price details on pages 258-265

| | | |
|----------|--------------------|---------|
| S210621* | Square | £165.60 |
| S210622* | Perch Square | £185.40 |
| S210623* | Round | £158.40 |
| S210624* | Perch Round | £181.80 |
| S210625* | 2 Seater | £216.00 |
| S210626* | 3 Seater | £255.60 |
| S210627* | Oval | £201.60 |
| S210628* | Wedge | £169.20 |
| S210629* | Quadrant ¼ Segment | £216.00 |
| S210630* | Tangent ½ Segment | £284.40 |
| S210631* | Tripod | £441.00 |
| S210632* | Octagon | £207.00 |
| S210633* | Arrow ¼ Segment | £208.80 |
| S210634* | Figure of 8 | £257.40 |
| S210635* | Opal | £342.00 |
| S210636* | Square Scoop | £187.20 |
| S210637* | 2 Seater Scoop | £243.00 |
| S210638* | 3 Seater Scoop | £307.80 |

* Please specify fabric colour





S210621
W400 x D400 x SH440mm



S210622
W400 x D400 x SH820mm



S210623
W400 x D400 x SH440mm



S210624
W400 x D400 x SH820mm



S210625
W800 x D400 x SH440mm



S210626
W1200 x D400 x SH440mm



S210627
W780 x D400 x SH440mm



S210628
W530/400 x D400 x SH440mm

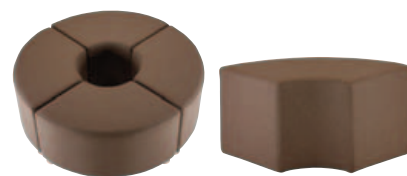

S210629
W860 x D400 x SH440mm

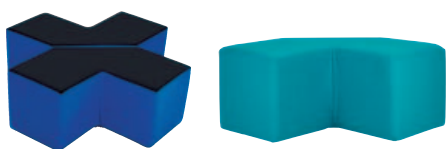

S210630
W790 x D400 x SH440mm



S210631
W980 x D980 x SH440mm

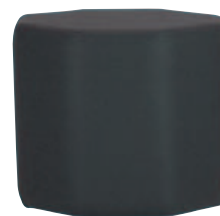

S210632
W470 x D470 x SH440mm

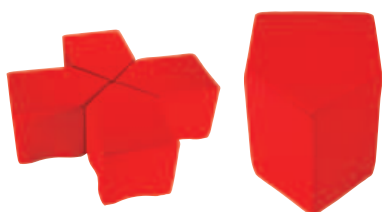

S210633
W790 x D600 x SH440mm



S210634
W980 x D400 x SH440mm



S210635
W1100 x D440 x SH440mm

Popular Colour Options
Main Line Plus Fabric

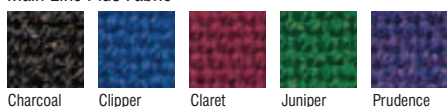

Charcoal Clipper Claret Juniper Prudence

Anti-microbial Just Colour Vinyl (add 15% to prices)



Grape Ocean Blue Citrus Green Cool Blue Deep Rose

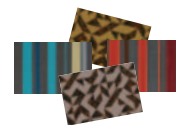

See pages 258-265 for further fabric options



CALL US ON 01527 878348



VISIT WWW.FORWARDPRODUCTS.CO.UK



Swirl Modular Chair

- A flexible range of modular seating with wide range of arm choices
- Fully upholstered modular furniture with deep filled cushions for comfort
- Matching table with oak or glass top
- W560 x D720 x H400mm plus arms
- Popular fabric options shown below. Many other fabric options available, please see ranges and price details on pages 258-265
- **Please see Important Furniture Ordering Information on page 3 before placing your furniture order**

| | | |
|----------|----------------------------------|---------|
| S211111* | Chair - No Arms | £135.30 |
| S211112* | Chair - Left Arm | £173.05 |
| S211113* | Chair - Right Arms | £173.05 |
| S211114* | Armchair | £220.60 |
| S211115* | 2 Seater Sofa with Arms | £358.77 |
| S211116* | 3 Seater Sofa with Arms | £528.85 |
| S211117* | Corner Unit | £227.22 |
| S211118* | 30° Internal Link | £167.21 |
| S211119* | 30° Internal Link with Left Arm | £207.95 |
| S211121* | 30° Internal Link with Right Arm | £207.95 |
| S211122* | 60° External Link | £166.90 |
| S211123* | 60° External Link with Left Arm | £206.14 |
| S211124* | 60° External Link with Right Arm | £202.52 |

| | | |
|----------|-----------------|---------|
| S211125* | Oak Top Table | £119.37 |
| S211126* | Glass Top Table | £119.37 |

* Please specify fabric colour

Popular Colour Options
Main Line Plus Fabric

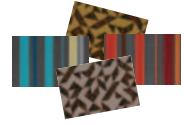
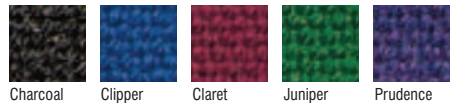

See pages 258-265 for further fabric options





Tangent Modular Chair

- Executive range of modular seating
- Seat height 400mm, seat width 610mm (without arms)
- Bespoke sizes available, please call for details
- Sprung, deep cushioned seats
- Square coffee table with glass top and upholstered sides
- Popular fabric options shown on previous page. Many other fabric options available, please see ranges and price details on pages 258-265
- **Please see Important Furniture Ordering Information on page 3 before placing your furniture order**



 Now available in anti-microbial woven fabric, effective against Covid-19 see page 262

| | | |
|----------|-------------------|---------|
| S211131* | Chair - No Arms | £199.68 |
| S211132* | Chair - Right Arm | £283.32 |
| S211133* | Chair - Left Arm | £283.32 |
| S211134* | Armchair | £352.71 |
| S211135* | Corner Unit | £261.44 |
| S211136* | Coffee Table | £190.22 |

* Please specify fabric colour

Torus Modular Chair

- Stylish modular seating
- Chrome feet as standard
- Comprehensive range
- Angled seats also available with arms, please call for details
- Popular fabric options shown on previous page. Many other fabric options available, please see ranges and price details on pages 258-265



| | | |
|----------|---------------------|---------|
| S211141* | Chair - No Arms | £210.52 |
| S211142* | Chair - Left Arm | £297.53 |
| S211143* | Chair - Right Arm | £297.53 |
| S211144* | Armchair | £372.54 |
| S211145* | 30° Concave Segment | £217.36 |
| S211146* | 60° Convex Segment | £217.36 |

* Please specify fabric colour



CALL US ON 01527 878348



VISIT WWW.FORWARDPRODUCTS.CO.UK

5 YEAR
GUARANTEE



Aruba Modular Chair

- Distinctly designed modular chair
- Looks good in any environment
- 5 year guarantee
- Tables with oak wood top
- Seat height 395mm, seat width 570mm
- Popular fabric options shown below. Many other fabric options available, please see ranges and price details on pages 258-265

| | | |
|----------|--------------|---------|
| S211151* | Chair | £237.67 |
| S211152* | Square Table | £154.06 |
| S211153* | Round Table | £234.26 |

* Please specify fabric colour

5 YEAR
GUARANTEE



Abingdon Visitor Chair

- Extra-large, deep cushioned chair for maximum comfort
- Durable, wooden frame with antibacterial lacquer
- 5 year guarantee
- Popular fabric options shown below. Many other fabric options available, please see ranges and price details on pages 258-265

| | | |
|----------|-----------------------|---------|
| T212571* | Medium Back | £260.93 |
| T212572* | Medium Back With Arms | £290.59 |
| T212573* | High Back | £282.22 |
| T212574* | High Back With Arms | £311.89 |

* Please specify fabric colour

5 YEAR
GUARANTEE



Lorenzo Wood Framed Chair

- Durable, wooden frame with antibacterial lacquer
- Are stackable 4 high
- 5 year guarantee
- Popular fabric options shown below. Many other fabric options available, please see ranges and price details on pages 258-265

| | | |
|----------|---------------------|---------|
| T212561* | Stacking Side Chair | £140.72 |
| T212562* | Arm Chair | £140.72 |

* Please specify fabric colour

Popular Colour Options
Main Line Plus Fabric

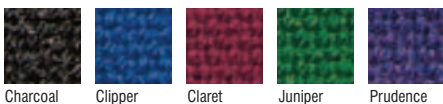

Charcoal

Clipper

Claret

Juniper

Prudence

Anti-microbial Just Colour Vinyl (add 15% to prices)



Grape

Ocean Blue

Citrus Green

Cool Blue

Deep Rose

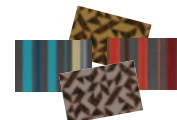

See pages 258-265 for further fabric options



Abingdon Seating

- Excellent for staffrooms, common rooms and heavy use areas
- Extra heavy duty skid base reception chair
- 25mm square tubular frame with 15 year guarantee
- Extra deep foam padding for extra comfort
- Black frame as standard, silver and grey available to order
- Size: W520 x D450 x H410mm
- Popular fabric options shown on previous page. Many other fabric options available, please see ranges and price details on pages 258-265

S211221* Side Chair £123.41

* Please specify fabric colour



Sherborne Seating

- Extremely durable range of chairs
- 25mm square tubular frame with a 15 year guarantee
- Extra deep foam padding
- Black frame as standard, silver and grey available to order
- Size: W520 x D450 x H410mm
- Popular fabric options shown on previous page. Many other fabric options available, please see ranges and price details on pages 258-265

S211211* Side Chair £108.57
S211214* Armchair £153.80

* Please specify fabric colour



 Now available in anti-microbial woven fabric, effective against Covid-19 see page 262





Antol Seating

- Classic attractive tub chair
- Sturdily built chair
- Attractive beech wood or chrome feet
- Deep, fibre-topped seat cushions
- Size: W720 x D510 x H470mm
2 seater width 1240mm
- Popular fabric options shown below. Many other fabric options available, please see ranges and price details on pages 258-265
- **Please see Important Furniture Ordering Information on page 3 before placing your furniture order**

Beech Feet

| | | |
|----------|-----------|---------|
| S211281* | Tub Chair | £394.97 |
| S211282* | 2 Seater | £578.97 |

Chrome Feet

| | | |
|----------|-----------|---------|
| S211283* | Tub Chair | £468.57 |
| S211284* | 2 Seater | £659.93 |

* Please specify fabric colour

Popular Colour Options
Main Line Plus Fabric

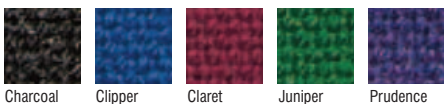

Anti-microbial Just Colour Vinyl (add 15% to prices)

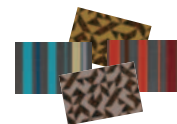

See pages 258-265 for further fabric options



Dominica Seating

- Contemporary designer tub seating
- Armchair and two seater options
- Rectangular glass coffee table W1200 x D600 x H465mm
- Two tone upholstery available, please call for pricing
- Chrome feet as standard
- Popular fabric options shown on previous page. Many other fabric options available, please see ranges and price details on pages 258-265



| | | |
|----------|--------------------------------|---------|
| S211291* | Tub Armchair | £470.40 |
| S211292* | Tub Two Seater | £837.20 |
| S211484 | Rectangular Glass Coffee Table | £324.79 |

* Please specify fabric colour

Please see Important Furniture Ordering Information on page 3 before placing your furniture order

Now available in anti-microbial woven fabric, effective against Covid-19 see page 262



Monaco Seating

- Distinctive modern seating
- Flared arm rests
- Armchair and two seater options
- Complements Dominica seating
- Chrome feet as standard
- Two tone upholstery available, please call for pricing
- Popular fabric options shown on previous page. Many other fabric options available, please see ranges and price details on pages 258-265



| | | |
|----------|---------------------------|---------|
| S211311* | Armchair | £470.40 |
| S211312* | Two Seater | £837.20 |
| S211483 | Square Glass Coffee Table | £268.80 |

* Please specify fabric colour



CALL US ON 01527 878348



VISIT WWW.FORWARDPRODUCTS.CO.UK



Memphis Tub Chair

- Classy designer tub chair at low prices
- Ideal for any reception area, staff seating area or student areas
- Comfortable deep padded seat
- Stylish Chrome feet
- Available in Black, Red, Navy, Brown or Cream Faux leather

| | | | |
|----------|-------------------|---------|---------|
| | | 1-9 | 10+ |
| S211241* | Memphis Tub Chair | £191.53 | £181.95 |

* Please specify colour

Please see Important Furniture Ordering Information on page 3 before placing your furniture order



Portland Tub Chair

- Stylish tub chair
- Ideal for head teacher's office or reception
- Very modern design
- Sturdy and comfortable
- Black faux leather finish
- Other colours available to order

| | | |
|---------|----------------------|---------|
| S211251 | Tub Chair Black | £233.25 |
| S211253 | Tub Two Seater Black | £344.76 |



Vancouver Tub Chair

With its deep, comfortable upholstery Vancouver makes the perfect chair for reception areas.

- Built with a robust wooden frame
- 5 year guarantee
- Popular fabric options shown below. Many other fabric options available, please see ranges and price details on pages 258-265

| | | |
|---------|---|---------|
| S212261 | Tub Chair | £298.79 |
| S212262 | Tub Sofa | £523.66 |
| S212263 | Round Stool with Chrome Legs & Single Scalloped Cut Out | £191.71 |
| S212264 | Round Stool with Chrome Legs & Double Scalloped Cut Out | £207.50 |



S212263
Single Scalloped



S212264
Double Scalloped

 Now available in anti-microbial woven fabric, effective against Covid-19 see page 262

Please see Important Furniture Ordering Information on page 3 before placing your furniture order



Lexington Tub Chair

- Compact stylish tub chair
- Modern chrome feet
- 2-tone fabric at no extra cost
- Ideal for areas with limited space
- Seat height 440mm, width 650mm overall
- Popular fabric options shown below. Many other fabric options available, please see ranges and price details on pages 258-265

Popular Colour Options
Main Line Plus Fabric



Charcoal Clipper Claret Juniper Prudence

Anti-microbial Just Colour Vinyl (add 15% to prices)



Grape Ocean Blue Citrus Green Cool Blue Deep Rose

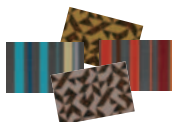

See pages 258-265 for further fabric options

| | | |
|----------|-----------|---------|
| S211271* | Tub Chair | £399.65 |
|----------|-----------|---------|

* Please specify fabric colour



CALL US ON 01527 878348



VISIT WWW.FORWARDPRODUCTS.CO.UK



Sorrento Seating

- Classy leather sofa range
- Attractive welded chrome frame
- Size: W580 or 1140 x D560 x H420mm
- Soft black leather upholstery
- **Please see Important Furniture Ordering Information on page 3 before placing your furniture order**



| | | |
|---------|-------------------|---------|
| S211321 | 1 Seater Armchair | £561.16 |
| S211322 | 2 Seater Sofa | £812.44 |





Atlanta Seating

- Attractive and popular Atlanta range
- Striking square features
- Deep fill cushions
- One, two and three seater options
- Funky chrome legs
- Popular fabric options shown below. Many other fabric options available, please see ranges and price details on pages 258-265
- **Please see Important Furniture Ordering Information on page 3 before placing your furniture order**



Perfect for reception areas and breakout zones

| | | |
|---------|-------------------|----------|
| S211341 | 1 Seater Armchair | £796.46 |
| S211342 | 2 Seater Sofa | £1344.06 |
| S211343 | 3 Seater Sofa | £1452.00 |

* Please specify fabric colour

Popular Colour Options

Main Line Plus Fabric

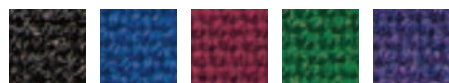

Charcoal Clipper Claret Juniper Prudence

Anti-microbial Just Colour Vinyl (add 15% to prices)



Grape Ocean Blue Citrus Green Cool Blue Deep Rose

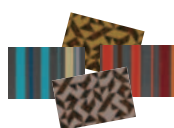

See pages 258-265 for further fabric options



Now available in anti-microbial woven fabric, effective against Covid-19 see page 262



CALL US ON 01527 878348



VISIT WWW.FORWARDPRODUCTS.CO.UK



Alfonso Seating

- Fantastic seating concept
- Endlessly flexible arrangements can be created
- Satin silver skid frame
- 5 year guarantee
- Popular fabric options shown below. Many other fabric options available, please see ranges and price details on pages 258-265
- **Please see Important Furniture Ordering Information on page 3 before placing your furniture order**

| | | |
|----------|--|---------|
| S211351* | Single Bench | £269.86 |
| S211352* | Single Seat with Back | £362.38 |
| S211353* | Single Seat with Back and Left Hand Arm | £454.91 |
| S211354* | Single Seat with Back and Right Hand Arm | £454.91 |
| S211355* | Double Bench | £402.22 |
| S211356* | Double Seat with Back | £553.86 |
| S211357* | Double Seat with Back and Left Hand Arm | £641.24 |
| S211358* | Double Seat with Back and Right Hand Arm | £641.24 |
| S211359* | 45 Degree Connecting Piece | £280.15 |
| S211361* | 90 Degree Connecting Piece | £345.68 |

* Please specify fabric colour

Popular Colour Options

Main Line Plus Fabric

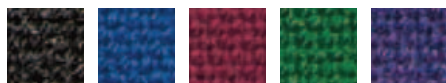

Charcoal Clipper Claret Juniper Prudence

Anti-microbial Just Colour Vinyl (add 15% to prices)



Grape Ocean Blue Citrus Green Cool Blue Deep Rose

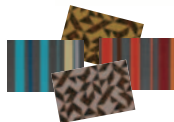

See pages 258-265 for further fabric options



Neapolitan Seating

- Unique tilting design
- Stylish chrome feet
- Well padded seat and back
- Matching armchair and coffee tables
- Two tone fabric available, please call for price
- Popular fabric options shown on previous page.
Many other fabric options available, please see ranges and price details on pages 258-265

| | | |
|----------|---------------------------|---------|
| S211371* | Chair - No Arms | £226.92 |
| S211372* | Armchair | £309.33 |
| S211373* | Coffee Table Glass Top | £201.84 |
| S211374* | Coffee Table Oak Wood Top | £205.42 |

* Please specify fabric colour



Please see Important Furniture Ordering Information on page 3 before placing your furniture order



Now available in anti-microbial woven fabric, effective against Covid-19 see page 262



Bugati Seating

- Eye catching and comfortable yet cost effective chair
- Distinctive sturdy build
- Attractive silver feet
- Can be used singularly or side by side
- 5 year guarantee
- Size: W550 x D570mm
- Popular fabric options shown on previous page.
Many other fabric options available, please see ranges and price details on pages 258-265

| | | |
|----------|-----------------|---------|
| S211381* | Reception Chair | £325.67 |
|----------|-----------------|---------|

* Please specify fabric colour

5 YEAR
GUARANTEE



CALL US ON 01527 878348



VISIT WWW.FORWARDPRODUCTS.CO.UK



Brooklyn Seating

- Versatile, quality modular seating system
- Comfortably sprung seats with well cushioned upholstery
- Stylish beech feet as standard, eco chrome feet available as an optional extra
- Ideal for breakout areas, reception areas, staffrooms and common rooms
- Two-tone fabric available, please call for price
- Popular fabric options shown below. Many other fabric options available, please see ranges and price details on pages 258-265
- **Please see Important Furniture Ordering Information on page 3 before placing your furniture order**

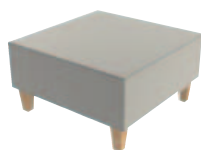

Single Seat Bench

- W730 x D720 x SH420mm

S211561* Single Bench £271.31

* Please specify fabric colour

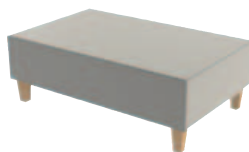

Double Seat Bench

- W1230 x D720 x SH420mm

S211562* Double Bench £375.25

* Please specify fabric colour



Single Seat With Back

- W730 x D720 x SH420mm

S211563* Single Seat With Back £363.79

* Please specify fabric colour



Single Seat With Corner Arm

- W940 x D720 x SH420mm

S211564* Corner Seat Right Arm £451.00

S211565* Corner Seat Left Arm £451.00

* Please specify fabric colour



Two Seater With Back

- W1230 x D720 x SH420mm

S211566* Two Seater With Back £541.72

* Please specify fabric colour



Two Seater With Corner Arm

- W1445 x D720 x SH420mm

S211567* Two Seater Left Arm £661.51

S211568* Two Seater Right Arm £661.51

* Please specify fabric colour



Two Seater Sofa

- W1880 x D720 x SH420mm

S211569* Two Seater Sofa £1005.00

* Please specify fabric colour

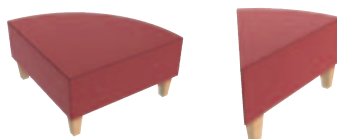

Angled Wedge Benches

- 45 degree wedge: W720 x D720 x SH420mm
- 90 degree wedge: W725 x D725 x SH420mm

S211571* 45° Wedge £275.70

S211572* 90° Wedge £375.25

* Please specify fabric colour

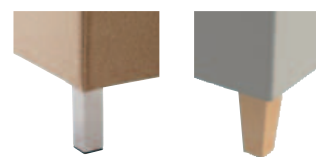

Eco Chrome Foot

Beech Foot
(supplied as standard)

Optional Extras

S211581 Eco Chrome Feet £49.88

S211582 Linking Plate £23.63

Popular Colour Options

Main Line Plus Fabric

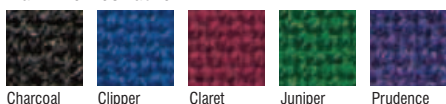

Charcoal

Clipper

Claret

Juniper

Prudence

Anti-microbial Just Colour Vinyl (add 15% to prices)



Grape

Ocean Blue

Citrus Green

Cool Blue

Deep Rose

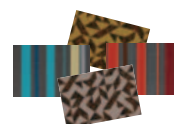

See pages 258-265 for further fabric options





Veneto Seating

- Modern feel with simple, clean lines
- Deep cushioning for extra comfort
- One, two and three seater options
- Popular fabric options shown on previous page. Many other fabric options available, please see ranges and price details on pages 258-265
- **Please see Important Furniture Ordering Information on page 3 before placing your furniture order**



Now available in anti-microbial woven fabric, effective against Covid-19 see page 262

Armchair : W810 x D760 x SH415mm

S211591 £1027.04

2 Seater Sofa: W1410 x D760 x SH415mm

S211592 £1373.12

3 Seater Sofa: W2010 x D760 x SH415mm

S211593 £1723.68



CALL US ON 01527 878348



VISIT WWW.FORWARDPRODUCTS.CO.UK



Full Back, Spider Base

+ Now available in anti-microbial woven fabric, effective against Covid-19 see page 262



Open Back, Spider Base



Open Back, 4 Leg

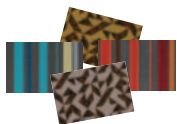

See pages 258-265 for further fabric options



Open Back, Skid Base

Tassimo Chair

- Eyecatching and comfortable breakout seating range
- Full back and open back options
- Open back chairs have curved base and waterfall arms
- Wide range of base options
- Platinum finish bases as standard
- Spider base available in chrome finish, please call for prices
- Popular fabric options shown below. Many other fabric options available, please see ranges and price details on pages 258-265
- **Please see Important Furniture Ordering Information on page 3 before placing your furniture order**

| | | |
|----------|--------------------------------|---------|
| S211651* | Full Back Chair, Spider Base | £357.63 |
| S211653* | Open Back Chair, Spider Base | £374.60 |
| S211654* | Open Back Chair, Four Leg Base | £338.53 |
| S211655* | Open Back Chair, Skid Base | £338.53 |

* Please specify fabric colour

Popular Colour Options

Main Line Plus Fabric



Charcoal Clipper Claret Juniper Prudence

Anti-microbial Just Colour Vinyl (add 15% to prices)



Grape Ocean Blue Citrus Green Cool Blue Deep Rose





Please see Important Furniture Ordering Information on page 3 before placing your furniture order



Academia Reading Pods

- High back study bean bags
- Perfect for reading and laptop use
- Waterproof and wipe clean
- H1180 x D660mm

S211531 Reading Pods - Fabric £102.17



Perfect for study zones, libraries and breakout areas



Academia Giant Bean Bag

- "Easi-in easi-out" bean bag with plenty of back support
- Waterproof and wipe clean
- High seat ideal for secondary school environments
- W920 x D900mm

S211541 Giant Bean Bag - Fabric £128.45

Academia Giant Floor Cushion

- Versatile giant floor cushion allowing multiple seating positions
- Big enough for students in flat position
- Waterproof and wipe clean fabric finish
- W1400 x L1800mm

S211551 Giant Floor Cushion - Fabric £136.04

Please Specify:

Fabric colour

Fabric Options



CALL US ON 01527 878348



VISIT WWW.FORWARDPRODUCTS.CO.UK



9

Office Furniture

| | |
|-------------------------|---------|
| Panel End Desks | 170-171 |
| Cantilever Desks | 172-173 |
| Executive Desks | 174-177 |
| Bench Desking | 178-181 |
| Pedestals | 182-183 |
| Height Adjustable Desks | 184-185 |
| Desk Extensions | 186 |
| Pigeon Hole Units | 187 |
| Accessories | 188-191 |
| Screens | 192-195 |
| Storage | 196-203 |
| Meeting Tables | 204-205 |
| Training Tables | 206-208 |
| Flip Top Tables | 209 |
| Boardroom Tables | 210-215 |
| Coffee Tables | 216-219 |



Sienna Panel End Desks

- For a smart and inexpensive desking solution, choose the Sienna Panel End desk range.
- The 25mm panel legs create a very strong workstation, and also give an extra degree of privacy
- All Sienna furniture is made in the UK and carries a 10 year warranty
- Supplied fully assembled for your convenience



Rectangular 800mm Deep

| | W x D x H(mm) | |
|---------|------------------|---------|
| O223611 | 800 x 800 x 740 | £152.18 |
| O223612 | 1000 x 800 x 740 | £159.43 |
| O223613 | 1200 x 800 x 740 | £166.68 |
| O223614 | 1400 x 800 x 740 | £174.53 |
| O223615 | 1600 x 800 x 740 | £182.38 |
| O223616 | 1800 x 800 x 740 | £191.44 |
| O223617 | 2000 x 800 x 740 | £200.49 |



Rectangular 600mm Deep

| | W x D x H(mm) | |
|---------|------------------|---------|
| O223621 | 800 x 600 x 740 | £144.94 |
| O223622 | 1000 x 600 x 740 | £150.98 |
| O223623 | 1200 x 600 x 740 | £158.83 |
| O223624 | 1400 x 600 x 740 | £166.07 |
| O223625 | 1600 x 600 x 740 | £173.32 |
| O223626 | 1800 x 600 x 740 | £181.77 |
| O223627 | 2000 x 600 x 740 | £190.83 |

Top Finishes





Crescent 800/600mm Ends

- Please specify hand (RH shown)

| | W x D x H(mm) | |
|---------|-------------------|---------|
| O223631 | 1200 x 1200 x 740 | £193.25 |
| O223632 | 1400 x 1200 x 740 | £201.70 |
| O223633 | 1600 x 1200 x 740 | £213.18 |
| O223634 | 1800 x 1200 x 740 | £224.65 |
| O223635 | 2000 x 1200 x 740 | £242.77 |



Wave 1000/800mm Ends

- Please specify hand (RH shown)

| | W x D x H(mm) | |
|---------|-------------------|---------|
| O223641 | 1000 x 1000 x 740 | £177.55 |
| O223642 | 1200 x 1000 x 740 | £183.59 |
| O223643 | 1400 x 1000 x 740 | £191.44 |
| O223644 | 1600 x 1000 x 740 | £199.29 |
| O223645 | 1800 x 1000 x 740 | £208.35 |



CALL US ON 01527 878348



VISIT WWW.FORWARDPRODUCTS.CO.UK



Sienna Cantilever Desks

- Looking for robust and inexpensive desks? The Sienna Cantilever range is for you! Available in all popular sizes, and in a wide range of wood finishes, these desks are ideal for educational settings
- All Sienna furniture is made in the UK and carries a 10 year warranty
- Supplied fully assembled for your convenience

Top Finishes



Metalwork Finishes - Silver supplied if not specified

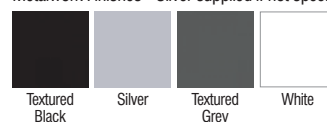

Rectangular 800mm Deep

| | W x D x H(mm) | |
|---------|------------------|---------|
| O223651 | 800 x 800 x 740 | £137.20 |
| O223652 | 1000 x 800 x 740 | £137.20 |
| O223653 | 1200 x 800 x 740 | £141.40 |
| O223654 | 1400 x 800 x 740 | £147.00 |
| O223655 | 1600 x 800 x 740 | £153.30 |
| O223656 | 1800 x 800 x 740 | £166.60 |



Rectangular 600mm Deep

| | W x D x H(mm) | |
|---------|------------------|---------|
| O223661 | 800 x 600 x 740 | £133.70 |
| O223662 | 1000 x 600 x 740 | £133.70 |
| O223663 | 1200 x 600 x 740 | £137.20 |
| O223664 | 1400 x 600 x 740 | £142.80 |
| O223665 | 1600 x 600 x 740 | £148.40 |
| O223666 | 1800 x 600 x 740 | £161.70 |



Crescent 800/600mm Ends

- Please specify hand (RH shown)

| | W x D x H(mm) | |
|---------|-------------------|---------|
| O223671 | 1400 x 1200 x 740 | £189.70 |
| O223672 | 1600 x 1200 x 740 | £201.60 |
| O223673 | 1800 x 1200 x 740 | £216.30 |



Wave 1000/800mm Ends

- Please specify hand (RH shown)

| | W x D x H(mm) | |
|---------|-------------------|---------|
| O223681 | 1000 x 1000 x 740 | £158.20 |
| O223682 | 1200 x 1000 x 740 | £162.40 |
| O223683 | 1400 x 1000 x 740 | £171.50 |
| O223684 | 1600 x 1000 x 740 | £193.90 |
| O223685 | 1800 x 1000 x 740 | £207.20 |





Sienna Executive Wire Managed Desks

- The Sienna Executive range brings together a stylish wire-managed frame design with a huge array of top shapes and sizes. Raise the bar with a modern looking office environment!
- Choose from a wide range of stylish wood finishes, and combine with metalwork colour of your choice!
- All Sienna furniture is made in the UK and carries a 10 year warranty
- Supplied fully assembled for your convenience

Rectangular 800mm Deep



| | W x D x H(mm) | |
|---------|------------------|---------|
| O223691 | 800 x 800 x 740 | £216.49 |
| O223692 | 1000 x 800 x 740 | £222.89 |
| O223693 | 1200 x 800 x 740 | £231.22 |
| O223694 | 1400 x 800 x 740 | £239.55 |
| O223695 | 1600 x 800 x 740 | £247.23 |
| O223696 | 1800 x 800 x 740 | £257.48 |
| O223697 | 2000 x 800 x 740 | £267.09 |

Rectangular 600mm Deep



| | W x D x H(mm) | |
|---------|------------------|---------|
| O223711 | 800 x 600 x 740 | £207.52 |
| O223712 | 1000 x 600 x 740 | £215.21 |
| O223713 | 1200 x 600 x 740 | £222.25 |
| O223714 | 1400 x 600 x 740 | £229.94 |
| O223715 | 1600 x 600 x 740 | £238.27 |
| O223716 | 1800 x 600 x 740 | £246.59 |
| O223717 | 2000 x 600 x 740 | £256.84 |

Top Finishes



Metalwork Finishes - Silver supplied if not specified

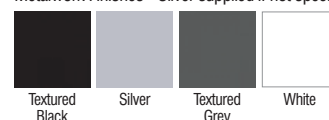

D Ended 800mm Deep

- Please specify hand (RH shown)

| | W x D x H(mm) | |
|---------|------------------|---------|
| O223721 | 2000 x 800 x 740 | £345.23 |
| O223722 | 2200 x 800 x 740 | £360.60 |



Angular 800 Ends

- Please specify hand (RH shown)

| | W x D x H(mm) | |
|---------|-------------------|---------|
| O223731 | 2000 x 1134 x 740 | £377.25 |
| O223732 | 2200 x 1134 x 740 | £395.83 |



S Shape 800/600mm Ends

- Please specify hand (RH shown)

| | W x D x H(mm) | |
|---------|-------------------|---------|
| O223741 | 1600 x 1200 x 740 | £303.60 |
| O223742 | 1800 x 1200 x 740 | £315.77 |
| O223743 | 2000 x 1200 x 740 | £337.54 |



Bow Front S Shape 800/600mm Ends

- Please specify hand (RH shown)

| | W x D x H(mm) | |
|---------|-------------------|---------|
| O223751 | 1600 x 1400 x 740 | £345.87 |
| O223752 | 1800 x 1400 x 740 | £376.61 |
| O223753 | 2000 x 1400 x 740 | £408.00 |



Compact S Shape 800/600mm Ends

- Please specify hand (RH shown)

| | W x D x H(mm) | |
|---------|-------------------|---------|
| O223761 | 1600 x 1000 x 740 | £301.68 |
| O223762 | 1800 x 1000 x 740 | £310.64 |



Symmetrical 800/800mm Ends

- Please specify hand (RH shown)

| | W x D x H(mm) | |
|---------|-------------------|---------|
| O223771 | 1600 x 1600 x 740 | £506.64 |
| O223772 | 1800 x 1800 x 740 | £536.74 |





Sienna Executive Wire Managed Desks Continued

Crescent 800/600mm Ends

- Please specify hand (RH shown)

| | W x D x H(mm) | |
|---------|-------------------|---------|
| O223781 | 1200 x 1200 x 740 | £259.40 |
| O223782 | 1400 x 1200 x 740 | £268.37 |
| O223783 | 1600 x 1200 x 740 | £280.54 |
| O223784 | 1800 x 1200 x 740 | £292.07 |
| O223785 | 2000 x 1200 x 740 | £311.28 |

Crescent 800/800mm Ends

- Please specify hand (RH shown)

| | W x D x H(mm) | |
|---------|-------------------|---------|
| O223791 | 1200 x 1200 x 740 | £267.73 |
| O223792 | 1400 x 1200 x 740 | £276.70 |
| O223793 | 1600 x 1200 x 740 | £289.51 |
| O223794 | 1800 x 1200 x 740 | £302.32 |
| O223795 | 2000 x 1200 x 740 | £322.17 |

Crescent 600/600mm Ends

- Please specify hand (RH shown)

| | W x D x H(mm) | |
|---------|-------------------|---------|
| O223811 | 1200 x 1200 x 740 | £251.08 |
| O223812 | 1400 x 1200 x 740 | £260.04 |
| O223813 | 1600 x 1200 x 740 | £271.57 |
| O223814 | 1800 x 1200 x 740 | £282.46 |
| O223815 | 2000 x 1200 x 740 | £301.68 |

Wave 1000/800mm Ends

- Please specify hand (RH shown)

| | W x D x H(mm) | |
|---------|-------------------|---------|
| O223821 | 1000 x 1000 x 740 | £242.11 |
| O223822 | 1200 x 1000 x 740 | £249.15 |
| O223823 | 1400 x 1000 x 740 | £257.48 |
| O223824 | 1600 x 1000 x 740 | £265.17 |
| O223825 | 1800 x 1000 x 740 | £275.42 |

Wave 800/600mm Ends

- Please specify hand (RH shown)

| | W x D x H(mm) | |
|---------|------------------|---------|
| O223831 | 1000 x 800 x 740 | £233.14 |
| O223832 | 1200 x 800 x 740 | £239.55 |
| O223833 | 1400 x 800 x 740 | £246.59 |
| O223834 | 1600 x 800 x 740 | £255.56 |
| O223835 | 1800 x 800 x 740 | £263.89 |

Double Wave 1000mm Ends

- Please specify hand (RH shown)

| | W x D x H(mm) | |
|---------|-------------------|---------|
| O223841 | 1600 x 1000 x 740 | £297.19 |
| O223842 | 1800 x 1000 x 740 | £308.08 |





Bow Fronted 1000mm Deep

- 800 ends

| | W x D x H(mm) | |
|---------|-------------------|---------|
| O223851 | 1200 x 1000 x 740 | £280.54 |
| O223852 | 1400 x 1000 x 740 | £287.58 |
| O223853 | 1600 x 1000 x 740 | £297.19 |
| O223854 | 1800 x 1000 x 740 | £308.08 |



120° Core Unit

| | W x D x H(mm) | Ends mm | |
|---------|-------------------|---------|---------|
| O223861 | 1558 x 970 x 740 | 600 | £416.97 |
| O223862 | 1905 x 1243 x 740 | 800 | £425.93 |
| O223863 | 2078 x 1120 x 740 | 600 | £451.55 |
| O223864 | 2078 x 1293 x 740 | 800 | £482.94 |



Curved 800mm Ends

| | W x D x H(mm) | |
|---------|------------------|---------|
| O223871 | 1800 x 950 x 740 | £387.50 |



Top Finishes



Metalwork Finishes - Silver supplied if not specified

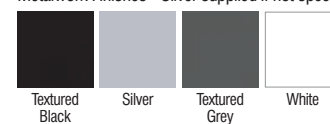

CALL US ON 01527 878348



VISIT WWW.FORWARDPRODUCTS.CO.UK



Sienna Bench Desks

- With clean and unfussy lines, Sienna bench desking creates a professional office environment at affordable prices
- Tops include a scallop for cables and top sizes over 1400mm wide accept return desks on page 180
- All Sienna furniture is made in the UK and carries a 10 year warranty
- Supplied fully assembled for your convenience

Single Bench Starter 800mm Deep

| | W x D x H(mm) | |
|---------|------------------|---------|
| O223881 | 1000 x 800 x 740 | £182.80 |
| O223882 | 1200 x 800 x 740 | £193.20 |
| O223883 | 1400 x 800 x 740 | £209.30 |
| O223884 | 1600 x 800 x 740 | £220.50 |
| O223885 | 1800 x 800 x 740 | £231.70 |

Single Bench Add-On 800mm Deep

| | W x D x H(mm) | |
|---------|------------------|---------|
| O223891 | 1000 x 800 x 740 | £163.80 |
| O223892 | 1200 x 800 x 740 | £173.60 |
| O223893 | 1400 x 800 x 740 | £188.30 |
| O223894 | 1600 x 800 x 740 | £198.80 |
| O223895 | 1800 x 800 x 740 | £208.60 |

Double Bench Starter 800mm Deep

| | W x D x H(mm) | |
|---------|-------------------|---------|
| O223911 | 1000 x 1600 x 740 | £324.80 |
| O223912 | 1200 x 1600 x 740 | £340.90 |
| O223913 | 1400 x 1600 x 740 | £357.00 |
| O223914 | 1600 x 1600 x 740 | £363.30 |
| O223915 | 1800 x 1600 x 740 | £379.40 |

Double Bench Add-On 800mm Deep

| | W x D x H(mm) | |
|---------|-------------------|---------|
| O223921 | 1000 x 1600 x 740 | £292.60 |
| O223922 | 1200 x 1600 x 740 | £307.30 |
| O223923 | 1400 x 1600 x 740 | £320.60 |
| O223924 | 1600 x 1600 x 740 | £327.60 |
| O223925 | 1800 x 1600 x 740 | £341.50 |



Single Bench Starter 600mm Deep

| | W x D x H(mm) | |
|---------|------------------|---------|
| O223931 | 1000 x 600 x 740 | £163.80 |
| O223932 | 1200 x 600 x 740 | £182.00 |
| O223933 | 1400 x 600 x 740 | £205.10 |
| O223934 | 1600 x 600 x 740 | £216.30 |
| O223935 | 1800 x 600 x 740 | £226.80 |



Single Bench Add-On 600mm Deep

| | W x D x H(mm) | |
|---------|------------------|---------|
| O223941 | 1000 x 600 x 740 | £147.00 |
| O223942 | 1200 x 600 x 740 | £163.80 |
| O223943 | 1400 x 600 x 740 | £184.80 |
| O223944 | 1600 x 600 x 740 | £193.90 |
| O223945 | 1800 x 600 x 740 | £205.10 |



Double Bench Starter 600mm Deep

| | W x D x H(mm) | |
|---------|-------------------|---------|
| O223951 | 1000 x 1200 x 740 | £288.40 |
| O223952 | 1200 x 1200 x 740 | £319.90 |
| O223953 | 1400 x 1200 x 740 | £352.80 |
| O223954 | 1600 x 1200 x 740 | £359.10 |
| O223955 | 1800 x 1200 x 740 | £375.20 |



Double Bench Add-On 600mm Deep

| | W x D x H(mm) | |
|---------|-------------------|---------|
| O223961 | 1000 x 1200 x 740 | £260.40 |
| O223962 | 1200 x 1200 x 740 | £287.70 |
| O223963 | 1400 x 1200 x 740 | £317.10 |
| O223964 | 1600 x 1200 x 740 | £322.70 |
| O223965 | 1800 x 1200 x 740 | £337.40 |



Top Finishes



Metalwork Finishes - Silver supplied if not specified



CALL US ON 01527 878348



VISIT WWW.FORWARDPRODUCTS.CO.UK



1000 x 600mm Bench Desk Return

| | W x D x H(mm) | |
|---------|------------------|---------|
| O223971 | 1000 x 600 x 740 | £151.90 |

Top Finishes



Metalwork Finishes - Silver supplied if not specified



Sienna Bench Desking Accessories

Bench Desk Extensions

| | W x D x H(mm) | |
|---------|-----------------|---------|
| O223981 | 1200 x 550 x 55 | £133.00 |
| O223982 | 1600 x 550 x 55 | £148.40 |

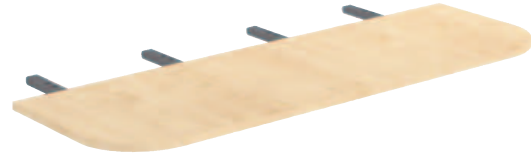

Mod Panels

- Hooks over frame - no tools needed

| | To Fit (mm) | |
|---------|-------------|---------|
| O223991 | 1000 | £59.50 |
| O223992 | 1200 | £64.40 |
| O223993 | 1400 | £73.50 |
| O223994 | 1600 | £87.50 |
| O223995 | 1800 | £102.20 |

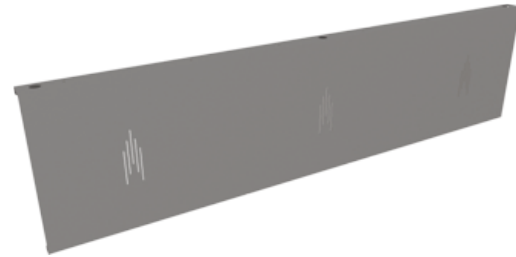

Cable Trays

| | To Fit (mm) | |
|---------|-------------|--------|
| O224011 | 1000 | £28.70 |
| O224012 | 1200 | £30.80 |
| O224013 | 1400 | £32.90 |
| O224014 | 1600 | £35.70 |
| O224015 | 1800 | £39.90 |



Wire-Managed Insert

- Fits to Add-On legs only

| | | |
|---------|-------------|--------|
| O224021 | Insert only | £94.50 |
|---------|-------------|--------|



Top Finishes



Metalwork Finishes - Silver supplied if not specified

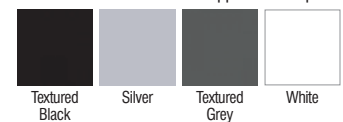

CALL US ON 01527 878348



VISIT WWW.FORWARDPRODUCTS.CO.UK



Sienna Pedestal Units

- Robust pedestal drawer units in matching wood finishes to the Sienna desking ranges
- All Sienna furniture is made in the UK and carries a 10 year warranty
- Supplied fully assembled for your convenience

Desk High Pedestal

- Locking, 2 Keys

W438 x D800 x H740mm

| | | |
|---------|-----------|---------|
| O224031 | 4 Drawers | £185.40 |
| O224032 | 3 Drawers | £185.40 |
| O224033 | 2 Drawers | £185.40 |

W438 x D600 x H740mm

| | | |
|---------|-----------|---------|
| O224036 | 4 Drawers | £166.07 |
| O224037 | 3 Drawers | £166.07 |
| O224038 | 2 Drawers | £166.07 |



Mobile Underdesk Pedestal

- Locking, 2 Keys

W438 x D550 x H635mm

| | | |
|---------|-----------|---------|
| O224041 | 4 Drawers | £168.49 |
| O224042 | 3 Drawers | £168.49 |
| O224043 | 2 Drawers | £168.49 |

W438 x D514 x H635mm

| | | |
|---------|-----------|---------|
| O224046 | 4 Drawers | £168.49 |
| O224047 | 3 Drawers | £168.49 |
| O224048 | 2 Drawers | £168.49 |



Small Mobile Pedestal

- Locking, 2 Keys

W438 x D605 x H595mm

| | | |
|---------|-----------|---------|
| O224111 | 3 Drawers | £140.10 |
| O224112 | 2 Drawers | £140.10 |

Wood Finishes



Drawer Options

2 Drawer



2 Deep Filing Drawers
NB: Files hang front to back

3 Drawer



2 Shallow Drawers 1 Deep
NB: Files hang front to back

4 Drawer



4 Shallow Drawers

Straight Pedestal Extension

- Locking, 2 Keys
- Adjustable feet
- Supplied assembled
- Price includes pedestal and extension top

W1000 x D800 x H740mm

| | | |
|---------|-----------|---------|
| O224071 | 4 Drawers | £224.65 |
| O224072 | 3 Drawers | £224.65 |
| O224073 | 2 Drawers | £224.65 |

W1000 x D600 x H740mm

| | | |
|---------|-----------|---------|
| O224076 | 4 Drawers | £197.48 |
| O224077 | 3 Drawers | £197.48 |
| O224078 | 2 Drawers | £197.48 |



Curved Pedestal Extension

- Locking, 2 Keys
- Adjustable feet
- Supplied assembled
- Price includes pedestal and extension top

W1000 x D800 x H740mm

| | | |
|---------|-----------|---------|
| O224091 | 4 Drawers | £247.00 |
| O224092 | 3 Drawers | £247.00 |
| O224093 | 2 Drawers | £247.00 |



Fixed Pedestal

- Locking, 2 Keys

W426 x D577 x H505mm

| | | |
|---------|-----------|---------|
| O224061 | 3 Drawers | £109.31 |
| O224062 | 2 Drawers | £109.31 |

W426 x D520 x H505mm

| | | |
|---------|-----------|---------|
| O224063 | 3 Drawers | £109.31 |
| O224064 | 2 Drawers | £109.31 |



CALL US ON 01527 878348



VISIT WWW.FORWARDPRODUCTS.CO.UK



Sienna Height Adjustable Desks

Sienna height adjustable desks are made in Europe with a minimalistic design and a reliable dual motor mechanism. Our three stage lifting column allows for an incredibly long stroke to cater for the smallest to the tallest user and with a 38mm per second movement you can get from sitting to standing in seconds.



Sienna Height Adjustable Desks

- 3 stage dual LINAK motor
- 670 - 1270mm height adjustment
- 5 year parts guarantee on electric components
- 10 years parts on wooden components
- Accepts standard screens with C clamp
- Only small pedestals will fit desk at lowest height
- High underdesk pedestals can fit providing desk is not lowered to lowest setting (or ideally programmed through software)

| | W x D(mm) | |
|---------|------------|---------|
| O224121 | 1000 x 800 | £672.53 |
| O224122 | 1200 x 800 | £689.18 |
| O224123 | 1400 x 800 | £706.47 |
| O224124 | 1600 x 800 | £723.77 |
| O224125 | 1800 x 800 | £741.06 |

| | W x D(mm) | |
|---------|------------|---------|
| O224131 | 1000 x 600 | £648.19 |
| O224132 | 1200 x 600 | £665.48 |
| O224133 | 1400 x 600 | £682.77 |
| O224134 | 1600 x 600 | £700.07 |
| O224135 | 1800 x 600 | £717.36 |



Single Wire Snake

- Tidy up your Sienna height adjustable desk with a wire snake
- Floor to desktop - for single desks only

| | |
|---------|--------|
| O224141 | £59.57 |
|---------|--------|



Metal Cable Tray

- Fixes to underside of desk to organise and tidy away your cables

| | To Fit (mm) | |
|---------|-------------|--------|
| O224151 | 1000 | £26.26 |
| O224152 | 1200 | £28.18 |
| O224153 | 1400 | £30.10 |
| O224154 | 1600 | £32.67 |
| O224155 | 1800 | £36.51 |

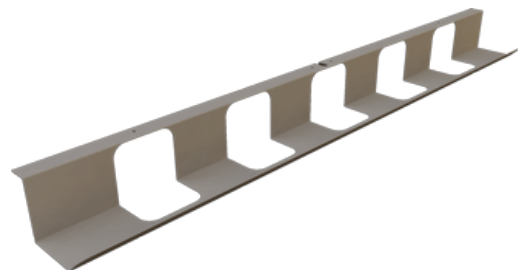

Top Finishes



Frame Colours



CALL US ON 01527 878348



VISIT WWW.FORWARDPRODUCTS.CO.UK

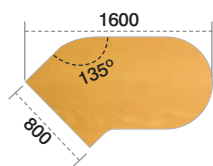

Sienna Meeting End Extension

- 60mm Tubular legs or Trumpet base
- Please specify left or right hand left hand shown on image, right hand on illustration

| | W x D x H(mm) | Leg Style | |
|---------|------------------|-----------|---------|
| O224161 | 1600 x 945 x 740 | Tubular | £315.77 |
| O224162 | 1600 x 945 x 740 | Trumpet | £350.99 |

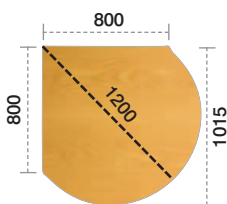

Sienna Teardrop Desk Extension

- 60mm tubular legs or trumpet base

| | W x D x H(mm) | Leg Style | |
|---------|-------------------|-----------|---------|
| O224171 | 1200 x 1015 x 740 | Tubular | £304.88 |
| O224172 | 1200 x 1015 x 740 | Trumpet | £345.23 |

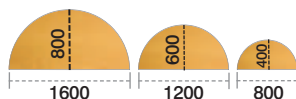

Sienna Radial Desk Extension

- 60mm Tubular legs

| | W x D x H(mm) | |
|---------|------------------|---------|
| O224181 | 1600 x 800 x 740 | £264.53 |
| O224182 | 1200 x 600 x 740 | £247.23 |
| O224183 | 800 x 400 x 740 | £219.05 |

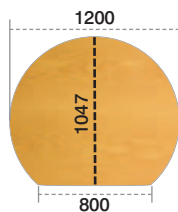

Sienna Radial Desk Extension

- 60mm Tubular legs or Trumpet base

| | W x D x H(mm) | Leg Style | |
|---------|-------------------|-----------|---------|
| O224191 | 1200 x 1047 x 740 | Tubular | £304.88 |
| O224192 | 1200 x 1047 x 740 | Trumpet | £345.23 |

Top Finishes



Metalwork Finishes - Silver supplied if not specified

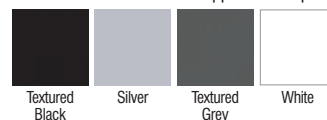



Windsor Pigeonhole Units

Pigeonhole units are still a very popular solution for storing and organising documents

- Manufactured from grade E1 melamine-faced high density particleboard
- 25mm top and base
- 18mm sides, shelves and doors
- Polypropylene feet
- The feet at the front of each unit have a height levelling mechanism built-in
- Compartment sizes 230 x 363 x 120mm high

| | W x D x H(mm) | Compartments | |
|---------|-------------------|--------------|---------|
| O224200 | 538 x 400 x 1900 | 20 | £438.16 |
| O224201 | 786 x 400 x 1900 | 30 | £528.05 |
| O224202 | 1034 x 400 x 1900 | 40 | £585.80 |
| O224203 | 1285 x 400 x 1900 | 50 | £652.74 |



O224200

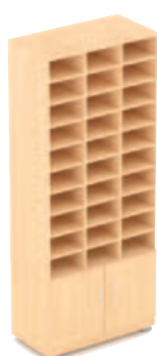

O224201



O224202



O224203

Wood Finishes

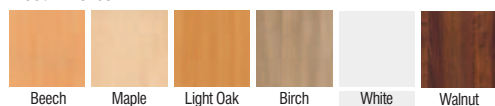

CALL US ON 01527 878348



VISIT WWW.FORWARDPRODUCTS.CO.UK

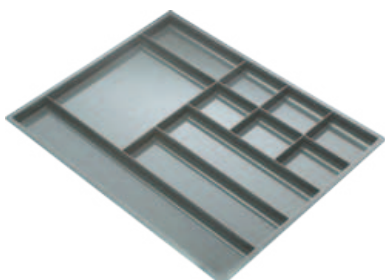
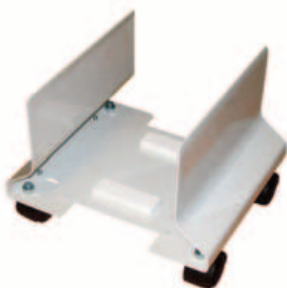

Cable Spine

- Fixes to underside of any top
- Silver

| | | |
|---------|--|--------|
| O224211 | | £40.99 |
|---------|--|--------|

80mm Cable Port

| | | |
|---------|--------|-------|
| O224221 | Grey | £4.48 |
| O224222 | Silver | £4.48 |

Single Monitor Arm

- Supplied with both through-desk & edge C-clamp fittings
- Vesa plate included
- Fully adjustable

| | | |
|---------|--|--------|
| O224231 | | £92.87 |
|---------|--|--------|

Double Monitor Arm

- Supplied with both through-desk & edge C-clamp fittings
- Vesa plate included
- Fully adjustable

| | | |
|---------|--|---------|
| O224241 | | £188.31 |
|---------|--|---------|

CPU Holder (Strapped)

- Please state which desk range the holder is being attached to
- Also suitable for bench desking

| | | |
|---------|--|--------|
| O224251 | | £57.00 |
|---------|--|--------|

CPU Holder (Adjustable)

- Please state which desk range the holder is being attached to
- Also suitable for bench desking

| | | |
|---------|--|---------|
| O224261 | | £108.24 |
|---------|--|---------|

Mobile Adjustable CPU Holder

| | | |
|---------|--|--------|
| O224262 | | £60.85 |
|---------|--|--------|

Table Connectors

- Supplied in a connecting pair (as per image)

| | | |
|---------|--|--------|
| O224271 | | £10.25 |
|---------|--|--------|

Pen Tray

- To fit in any 438mm width pedestal
- O224281 is a factory fitted option
- O224291 is a drop-in tray (cannot fit in top drawers due to locking mechanism)

| | | |
|---------|----------------|--------|
| O224281 | Factory Fitted | £39.71 |
| O224291 | Drop-in | £12.81 |



4 Gang Power Socket

- Unswitched
- Includes 3m power cable
- Spare fuse in every socket

| | |
|---------|--------|
| O224311 | £35.87 |
|---------|--------|



Desktop Power Module

- Includes 3m power cable
- Spare fuse in every socket
- 2 Power 2 USB charge 1 Switch

| | |
|---------|---------|
| O224321 | £140.27 |
|---------|---------|



Flip Power Module

- Includes 3m power cable
- Spare fuse in every socket
- 2 Power 2 Data 1 Switch
- Factory-fitted includes fitting module into table of your choice

| | |
|---------|------------------------|
| O224331 | £162.05 |
| O224332 | Factory-fitted £206.88 |



Cable Access Module

- Available in black, white and silver
- Single or double option available.
- Factory-fitted includes fitting module into table of your choice
- Other sizes available

| | | |
|---------|----------------|--------|
| O224341 | Single Option | £42.27 |
| O224342 | Factory-fitted | £87.11 |
| O224343 | Double Option | £47.40 |
| O224344 | Factory-fitted | £92.23 |

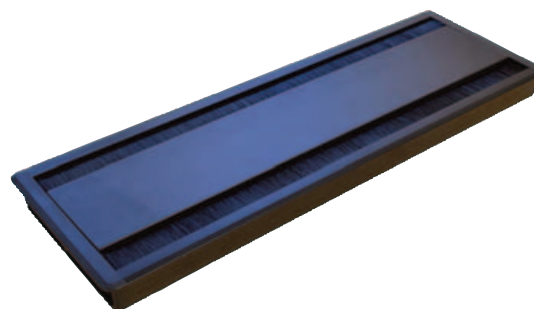

Metal Cable Tray

- Please state which desk range the tray is fitting on to

| | To Fit (mm) | |
|---------|-------------|--------|
| O224361 | 600 | £23.06 |
| O224362 | 800 | £24.34 |
| O224363 | 1000 | £26.26 |
| O224364 | 1200 | £28.18 |
| O224365 | 1400 | £30.10 |
| O224366 | 1600 | £32.67 |
| O224367 | 1800 | £36.51 |
| O224368 | 2000 | £41.63 |

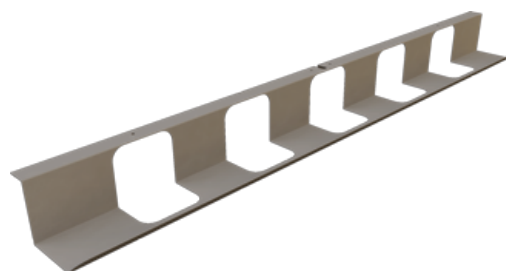



Arc - Wireless Charger

- Arc H LD 10 Watts of wireless charging power
- Includes 1.5m power cable
- Supplied loose, fixes to underside of any top
- Silver

| | |
|---------|--------|
| O224371 | £55.08 |
|---------|--------|



Powerdot 80mm Grommet

- Supplied loose, slots into any desk with a cable grommet
- Can be fitted to units without cable grommets, please call for price

| | | |
|---------|---------------------------------------|---------|
| O224391 | 1 x UK Fused Socket | £44.19 |
| O224392 | 1 x TUF (A+C) USB Fast Charging | £90.31 |
| O224393 | 1 x TUF (A+C) USB Fast Charging, Data | £102.48 |

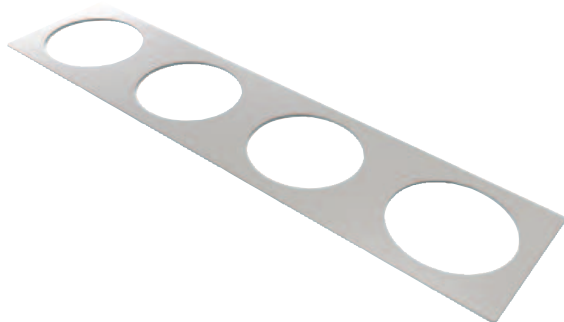

Powerdot Frame

- Metal frame for power dot, available in black, white and silver

| | | |
|---------|--------------|--------|
| O224411 | 2 Hole Frame | £33.31 |
| O224412 | 4 Hole Frame | £52.52 |



Podium Socket Box

- 2 x UK fused Socket
- 1 x TUF-R (A+C) USB Fast Charging
- 2 x RJ45 Outlet with CAT 5E or CAT 6 data
- Based on Stainless Steel, Simple clamping kit
- Factory-fitted into furniture unit of your choice, please call to confirm positioning required

| | |
|---------|---------|
| O224431 | £376.69 |
|---------|---------|



Puma Socket Box

- 2 or 3 gang option
- 2 x UK fused sockets, 1 x TUF-R (A+C)
- USB Fast Charging
- Factory-fitted into furniture unit of your choice, please call to confirm positioning required

| | |
|---------|---------|
| O224441 | £149.24 |
|---------|---------|



Pluto Socket Box

- 2 x UK fused Socket
- 1 x TUF-R (A+C) USB Fast Charging
- For 80mm aperture or rubber feet with side exit cable
- Available in various colours
- Supplied loose, slots into any desk with a cable grommet
- Can be fitted to units without cable grommets, please call for price

O224451

£206.24

Pluto Data Cartridge Socket Box

- 2 x RJ45 outlet
- 1 x HDMI
- Requires Pluto main module to work
- Supplied loose, slots into any desk with a cable grommet
- Can be fitted to units without cable grommets, please call for price

O224461

£218.41

Phase Socket Box

- 1 x UK fused Socket
- 1 x TUF-R (A+C) USB Fast Charging
- Screw down bracket
- In white or black
- Supplied loose, fixes to underside of any top

O224471

£182.54

Pandora Socket Box

- 2 x UK fused sockets
- 1 x TUF-R (A+C) USB Fast Charging
- Inlay frame – Black with stainless steel bezel
- Module flips to hide sockets and gives a smooth flat finish, available in a number of finishes
- Supplied loose, slots into any desk with a cable grommet
- Can be fitted to units without cable grommets, please call for price

O224481

£262.61

Prism Socket Box

- 2 or 4 x UK fused socket
- 2 or 4 x RJ45 Outlet CAT 5e or CAT 6
- Black socket fascia's endcaps and flexilip natural anodised internal and external extrusion
- Factory-fitted into furniture unit of your choice, please call to confirm positioning required

O224491 2 or 4 x UK fused Socket £247.95

O224492 2 or 4 x RJ45 Outlet CAT 5e or CAT6 £362.60

Nilla Lamp

- 1100 / 880 / 660 / 440 / 220 Lux
- 95 Lm/W
- 4 hour eco-timer
- 1 x USB-charger (5v, 2.1 A)
- 220-240V, DC 12V 2A, Max 24W
- 7W power consumption (Energy A rating)
- LED lamp with USB charger
- Adjustable brightness with eco timer

O224511

£144.11



CALL US ON 01527 878348



VISIT WWW.FORWARDPRODUCTS.CO.UK



Floorstanding Screens

- For noise reduction and privacy, floor standing screens come in a variety of heights and widths.
- Choose linking screens if you need to separate larger areas with more than just one screen.
- Please select code from grid that combines the required width and height

Popular Colour Options
Standard Fabric - Cara

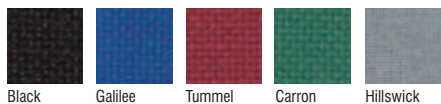

Black Galilee Tummel Carron Hillswick

Premium Fabric - Lucia (add 10% to prices)

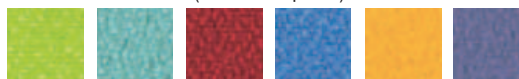

Madura Campeche Calypso Bluebell Solano Mauve

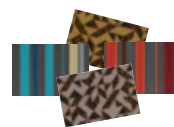

See pages 266-267 for further fabric options



Floorstanding Screens 1000, 1100 & 1200mm High

- Includes T feet as standard
- Please select code from grid that combines the required width and height

| Width | Height 1000mm | Height 1100mm | Height 1200mm | |
|--------|------------------|------------------|------------------|---------|
| 1000mm | O224521 | O224531 | O224541 | £181.17 |
| 1100mm | O224522 | O224532 | O224542 | £188.42 |
| 1200mm | O224523 | O224533 | O224543 | £195.66 |
| 1300mm | O224524 | O224534 | O224544 | £202.91 |
| 1400mm | O224525 | O224535 | O224545 | £210.16 |
| 1500mm | O224526 | O224536 | O224546 | £217.40 |
| 1600mm | O224527 | O224537 | O224547 | £224.65 |
| 1700mm | O224528 | O224538 | O224548 | £231.90 |
| 1800mm | O224529 | O224539 | O224549 | £239.14 |

Floorstanding Screens 1300, 1400 & 1500mm High

- Includes T feet as standard
- Please select code from grid that combines the required width and height

| Width | Height 1300mm | Height 1400mm | Height 1500mm | |
|--------|------------------|------------------|------------------|---------|
| 1000mm | O224551 | O224561 | O224571 | £210.16 |
| 1100mm | O224552 | O224562 | O224572 | £217.40 |
| 1200mm | O224553 | O224563 | O224573 | £224.65 |
| 1300mm | O224554 | O224564 | O224574 | £231.90 |
| 1400mm | O224555 | O224565 | O224575 | £239.14 |
| 1500mm | O224556 | O224566 | O224576 | £246.39 |
| 1600mm | O224557 | O224567 | O224577 | £253.64 |
| 1700mm | O224558 | O224568 | O224578 | £260.88 |
| 1800mm | O224559 | O224569 | O224579 | £268.13 |

Floorstanding Screens 1600, 1700 & 1800mm High

- Includes T feet as standard
- Please select code from grid that combines the required width and height

| Width | Height 1600mm | Height 1700mm | Height 1800mm | |
|--------|------------------|------------------|------------------|---------|
| 1000mm | O224581 | O224591 | O224611 | £231.90 |
| 1100mm | O224582 | O224592 | O224612 | £239.14 |
| 1200mm | O224583 | O224593 | O224613 | £246.39 |
| 1300mm | O224584 | O224594 | O224614 | £253.64 |
| 1400mm | O224585 | O224595 | O224615 | £260.88 |
| 1500mm | O224586 | O224596 | O224616 | £268.13 |
| 1600mm | O224587 | O224597 | O224617 | £282.63 |
| 1700mm | O224588 | - | - | £289.87 |
| 1800mm | O224589 | - | - | £299.53 |

Linking Screens 1000, 1100 & 1200mm High

- Includes T feet as standard
- Please select code from grid that combines the required width and height

| Width | Height 1000mm | Height 1100mm | Height 1200mm | |
|--------|------------------|------------------|------------------|---------|
| 1000mm | O224521L | O224531L | O224541L | £202.31 |
| 1100mm | O224522L | O224532L | O224542L | £209.55 |
| 1200mm | O224523L | O224533L | O224543L | £216.80 |
| 1300mm | O224524L | O224534L | O224544L | £224.05 |
| 1400mm | O224525L | O224535L | O224545L | £231.29 |
| 1500mm | O224526L | O224536L | O224546L | £238.54 |
| 1600mm | O224527L | O224537L | O224547L | £245.79 |
| 1700mm | O224528L | O224538L | O224548L | £253.03 |
| 1800mm | O224529L | O224539L | O224549L | £260.28 |

Linking Screens 1300, 1400 & 1500mm High

- Includes T feet as standard
- Please select code from grid that combines the required width and height

| Width | Height 1300mm | Height 1400mm | Height 1500mm | |
|--------|------------------|------------------|------------------|---------|
| 1000mm | O224551L | O224561L | O224571L | £233.71 |
| 1100mm | O224552L | O224562L | O224572L | £240.96 |
| 1200mm | O224553L | O224563L | O224573L | £248.20 |
| 1300mm | O224554L | O224564L | O224574L | £255.45 |
| 1400mm | O224555L | O224565L | O224575L | £262.70 |
| 1500mm | O224556L | O224566L | O224576L | £269.94 |
| 1600mm | O224557L | O224567L | O224577L | £277.19 |
| 1700mm | O224558L | O224568L | O224578L | £284.44 |
| 1800mm | O224559L | O224569L | O224579L | £291.68 |

Linking Screens 1600, 1700 & 1800mm High

- Includes T feet as standard
- Please select code from grid that combines the required width and height

| Width | Height 1600mm | Height 1700mm | Height 1800mm | |
|--------|------------------|------------------|------------------|---------|
| 1000mm | O224581L | O224591L | O224611L | £257.87 |
| 1100mm | O224582L | O224592L | O224612L | £265.11 |
| 1200mm | O224583L | O224593L | O224613L | £272.36 |
| 1300mm | O224584L | O224594L | O224614L | £279.61 |
| 1400mm | O224585L | O224595L | O224615L | £286.85 |
| 1500mm | O224586L | O224596L | O224616L | £294.10 |
| 1600mm | O224587L | O224597L | O224617L | £308.59 |
| 1700mm | O224588L | - | - | £315.84 |
| 1800mm | O224589L | - | - | £325.50 |



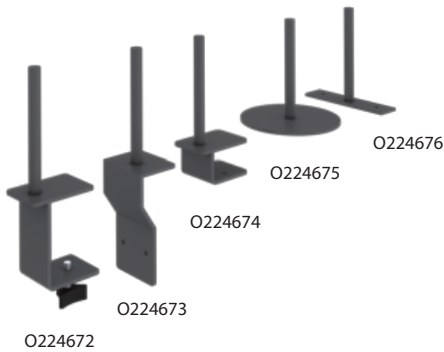

Standard Desktop Screens

- Available in a wide range of sizes and finishes.
- Supplied non-linking as standard.
- Linking option available for additional £45 + VAT, please specify if required.

A. Rectangular Desktop Screen

- Available in 300mm, 380mm & 480mm heights - please specify when ordering
- Supplied with standard C clamp brackets, see below for other clamp options available for an extra cost

| | Width(mm) | |
|---------|-----------|---------|
| O224631 | 800 | £73.66 |
| O224632 | 1000 | £74.94 |
| O224633 | 1100 | £78.14 |
| O224634 | 1200 | £79.42 |
| O224635 | 1400 | £83.27 |
| O224636 | 1500 | £86.47 |
| O224637 | 1600 | £89.67 |
| O224638 | 1638 | £89.67 |
| O224639 | 1800 | £92.23 |
| O224641 | 2000 | £101.20 |

B. Shaped Desktop Screen

- Available in 300mm, 380mm & 480mm heights - please specify when ordering
- Supplied with standard C clamp brackets, see below for other clamp options available for an extra cost

| | Width(mm) | |
|---------|-----------|---------|
| O224651 | 800 | £79.42 |
| O224652 | 1000 | £84.55 |
| O224653 | 1100 | £86.47 |
| O224654 | 1200 | £88.39 |
| O224655 | 1400 | £91.59 |
| O224656 | 1500 | £94.79 |
| O224657 | 1600 | £96.62 |
| O224658 | 1638 | £96.72 |
| O224659 | 1800 | £101.84 |
| O224661 | 2000 | £109.53 |

C. Screen Clamps

- Individual Single Clamp (as shown)

| | | |
|---------|-----------|--------|
| O224672 | Over-Leg | £11.53 |
| O224673 | Panel End | £11.53 |
| O224674 | End | £11.53 |
| O224675 | Circular | £11.53 |
| O224676 | T | £11.53 |

Popular Colour Options
Standard Fabric - Cara

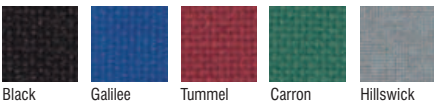

Premium Fabric - Lucia (add 10% to prices)

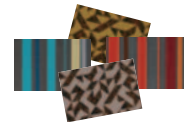
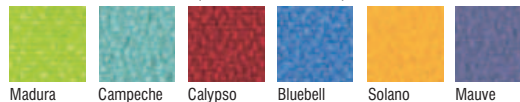

See pages 266-267 for further fabric options



A. Premium Aluminium Desktop Screen

- Premium desktop screens with an aluminium System Surround that accepts the below accessories.
- Non-linking, non-pinnable
- Available in 300mm, 380mm and 480mm high at the same price - supplied 480mm high if not specified

| | Width(mm) | |
|---------|-----------|---------|
| O224681 | 800 | £99.92 |
| O224682 | 1000 | £105.04 |
| O224683 | 1100 | £107.60 |
| O224684 | 1200 | £110.17 |
| O224685 | 1400 | £113.37 |
| O224686 | 1500 | £117.85 |
| O224687 | 1600 | £121.70 |
| O224688 | 1638 | £121.70 |
| O224689 | 1800 | £124.90 |
| O224691 | 2000 | £136.43 |



Popular Colour Options

Standard Fabric - Cara

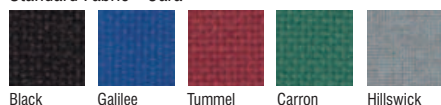

Black

Gaillee

Tummel

Carron

Hillswick

Premium Fabric - Lucia (add 10% to prices)

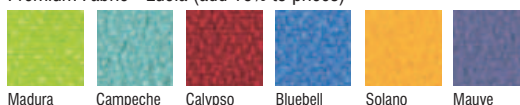

Madura

Campeche

Calypso

Bluebell

Solano

Mauve

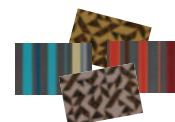

See pages 266-267 for further fabric options

B. Single Toolbar Monitor Arm

- Available in silver only

| | |
|---------|---------|
| O224711 | £121.70 |
|---------|---------|



C. Single Toolbar Monitor Arm

- Available in Silver only

| | |
|---------|--------|
| O224721 | £67.25 |
|---------|--------|



D. Metal Toolbar A4 Paper Tray

- Landscape
- Available in Silver only

| | |
|---------|--------|
| O224731 | £39.07 |
|---------|--------|

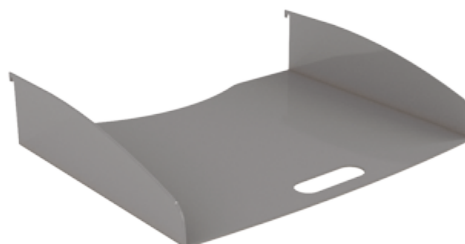

Sienna storage units are made in the UK with a 10 year warranty and are supplied fully assembled



Base Unit

- Locking, 2 Keys
- 1 Adjustable shelf
- Adjustable feet

| | W x D x H(mm) | |
|----------|------------------|---------|
| O224741 | 800 x 600 x 740 | £234.42 |
| O224742 | 1000 x 600 x 740 | £254.28 |
| O224743* | 1200 x 600 x 740 | £285.66 |

* These units have a central support

Glass Door Base Unit

- 1 Adjustable shelf
- Adjustable feet

| | W x D x H(mm) | |
|----------|------------------|---------|
| O224751 | 800 x 600 x 740 | £373.41 |
| O224752 | 1000 x 600 x 740 | £408.64 |
| O224752* | 1200 x 600 x 740 | £447.07 |

* These units have a central support

Sliding Door Base Unit

- Locking, 2 keys
- 1 Adjustable shelf

| | W x D x H(mm) | |
|----------|------------------|---------|
| O224761 | 800 x 600 x 740 | £288.87 |
| O224762 | 1000 x 600 x 740 | £331.14 |
| O224763* | 1200 x 600 x 740 | £367.01 |
| O224764* | 1600 x 600 x 740 | £452.83 |

* These units have a central support

Credenza

- Locking, 2 keys
- Adjustable feet
- Unit has centre support
- O224771 is supplied with adjustable shelf
- O224772 is supplied with adjustable shelf on one side and fridge on other side (includes ventilation holes)
- Dimensions W1200 x D600 x H740mm

| | | |
|---------|------------------------------|---------|
| O224771 | Credenza with Shelf | £304.88 |
| O224772 | Credenza with Shelf & Fridge | £627.05 |

Wood Finishes



Side Filer

- Locking, 2 keys
- Accepts foolscap files

| | W x D x H(mm) | |
|-----------|-----------------|---------|
| O224781 * | 800 x 600 x 740 | £479.09 |



Desk High Tambour

- Accommodates 2 rows of A4 filing
- Locking, 2 keys
- 1 Adjustable shelf
- Hidden adjustable feet
- Silver tambour doors

| | W x D x H(mm) | |
|---------|-----------------|---------|
| O224791 | 800 x 600 x 740 | £429.78 |



90° Desk High Tambour

- Accommodates 2 rows of A4 filing
- Locking, 2 keys
- 1 Fixed shelf
- Hidden adjustable feet
- Silver tambour doors

| | W x D x H(mm) | |
|---------|-----------------|---------|
| O224811 | 800 x 800 x 740 | £466.92 |



Small Sideboard Unit

- Locking, 2 Keys
- 1 Adjustable shelf, adjustable feet
- Drawers determine hand (RH shown)
- Please specify hand required when ordering

| | W x D x H(mm) | | |
|---------|------------------|----------|---------|
| O224821 | 1200 x 600 x 740 | Open | £327.30 |
| O224822 | 1200 x 600 x 740 | 2 Drawer | £421.45 |
| O224823 | 1200 x 600 x 740 | 3 Drawer | £421.45 |
| O224824 | 1200 x 600 x 740 | 4 Drawer | £421.45 |



Sideboard Unit

- Locking, 2 keys
- 1 Adjustable shelf (each side)
- Adjustable feet

| | W x D x H(mm) | | |
|---------|------------------|----------|---------|
| O224831 | 1600 x 600 x 740 | Open | £527.77 |
| O224832 | 1600 x 600 x 740 | 2 Drawer | £620.64 |
| O224833 | 1600 x 600 x 740 | 3 Drawer | £620.64 |
| O224834 | 1600 x 600 x 740 | 4 Drawer | £620.64 |



Sienna storage units are made in the UK with a 10 year warranty and are supplied fully assembled



Top Unit

- Units have a flush base allowing for 2x lever arch files to fit

| | W x D x H(mm) | Adjustable Shelves | |
|----------|------------------|--------------------|---------|
| O224841 | 800 x 410 x 740 | 1 | £127.46 |
| O224842 | 800 x 410 x 1060 | 2 | £147.96 |
| O224843* | 1200 x 410 x 740 | 1 | £166.53 |
| O224844* | 1600 x 410 x 740 | 1 | £185.75 |

* These units have a central support

Sliding Door Glazed Top Unit

- Optional extra lock for doors

| | W x D x H(mm) | Adjustable Shelves | |
|---------|------------------|--------------------|---------|
| O224851 | 800 x 410 x 740 | 1 | £285.66 |
| O224852 | 800 x 410 x 1060 | 2 | £313.85 |
| O224853 | Lock | | £27.54 |

Glass Door Top Unit

- Non-locking

| | W x D x H(mm) | Adjustable Shelves | |
|----------|------------------|--------------------|---------|
| O224861 | 800 x 410 x 740 | 1 | £346.51 |
| O224862 | 800 x 410 x 1060 | 2 | £411.20 |
| O224863* | 1200 x 410 x 740 | | £430.42 |

* These units have a central support

90° Desk High Bookcase

- 25mm top & shelves
- 1 Fixed Shelf
- Adjustable Feet

| | W x D x H(mm) | End | |
|---------|-----------------|-----|---------|
| O224871 | 600 x 600 x 740 | 600 | £242.75 |
| O224872 | 800 x 800 x 740 | 800 | £260.04 |

Wood Finishes



Document Sorter

- 25mm top & shelves
- Compartment size 240W x 190H

| | W x D x H(mm) | |
|---------|------------------|---------|
| O224881 | 800 x 332 x 1102 | £324.09 |



Multi Combi Unit

- Right hand shown (position of cupboard determines hand)
- Locking, 2 Keys
- Unit supplied with sliding glide feet
- Silver tambour doors

| | W x D x H(mm) | |
|---------|------------------|---------|
| O224891 | 650 x 800 x 1200 | £817.28 |



Desktop Overhead Tambour

- Locking
- Frame height clearance 505mm
- Accommodates A4 box files
- Silver tambour doors

| | W x D x H(mm) | |
|---------|-------------------|---------|
| O224911 | 1600 x 465 x 1010 | £522.65 |
| O224912 | 1800 x 465 x 1010 | £554.67 |



Glass 2 Door Cupboard

- Non-locking

| | W x D x H(mm) | Adjustable Shelves | |
|---------|------------------|--------------------|---------|
| O224921 | 800 x 410 x 740 | 1 | £346.51 |
| O224922 | 800 x 410 x 1200 | 2 | £507.92 |
| O224923 | 800 x 410 x 1600 | 3 | £586.06 |
| O224924 | 800 x 410 x 1800 | 3 | £618.08 |
| O224925 | 800 x 410 x 2000 | 4 | £653.95 |

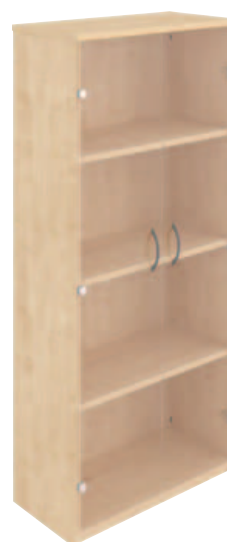

Sienna storage units are made in the UK with a 10 year warranty and are supplied fully assembled



Desk High Mobile Storage Unit

- Single Sided
- Unit comes on castors
- 2 Adjustable shelves

| | W x D x H(mm) | |
|----------|------------------|---------|
| O225011 | 1000 x 410 x 740 | £273.49 |
| O225012* | 1200 x 410 x 740 | £293.35 |
| O225013* | 1600 x 410 x 740 | £331.14 |

* These units have a central support

Desk High Mobile Storage Unit

- Double Sided
- Unit comes on castors
- 4 Adjustable shelves

| | W x D x H(mm) | |
|----------|------------------|---------|
| O225021 | 1000 x 600 x 740 | £367.01 |
| O225022* | 1200 x 600 x 740 | £441.30 |
| O225023* | 1600 x 600 x 740 | £587.98 |

* These units have a central support

Under Desk Storage Mobile Unit

- Please specify left or right handed
- Left hand shown (position of cupboard determines hand)

| | W x D x H(mm) | |
|---------|------------------|---------|
| O225031 | 1200 x 400 x 620 | £464.36 |
| O225032 | 1600 x 400 x 620 | £500.87 |

Under Desk Mobile Storage Unit

- Single Sided
- 25mm top & shelves
- Unit comes on castors
- 2 Adjustable shelves

| | W x D x H(mm) | |
|----------|------------------|---------|
| O225041 | 1000 x 410 x 620 | £297.83 |
| O225042* | 1200 x 410 x 620 | £356.76 |
| O225043* | 1600 x 410 x 620 | £476.53 |

* These units have a central support

Under Desk Mobile Storage Unit

- Double Sided
- 25mm top & shelves
- Unit comes on castors
- 4 Adjustable shelves

| | W x D x H(mm) | |
|----------|------------------|---------|
| O225051 | 1000 x 600 x 620 | £348.43 |
| O225052* | 1200 x 600 x 620 | £417.61 |
| O225053* | 1600 x 600 x 620 | £555.95 |

* These units have a central support



Bookcase

| | W x D x H(mm) | Adjustable Shelves | |
|----------|-------------------|--------------------|---------|
| O225061 | 800 x 410 x 2000 | 4 | £252.36 |
| O225062 | 800 x 410 x 1800 | 3 | £228.66 |
| O225063 | 800 x 410 x 1600 | 3 | £211.37 |
| O225064 | 800 x 410 x 1200 | 2 | £152.44 |
| O225065 | 800 x 410 x 1000 | 2 | £134.51 |
| O225066 | 800 x 410 x 740 | 1 | £127.46 |
| O225067* | 800 x 410 x 740 | 1 | £127.46 |
| O225068 | 1000 x 410 x 2000 | 4 | £294.63 |
| O225069 | 1000 x 410 x 1800 | 3 | £270.29 |
| O225071 | 1000 x 410 x 1600 | 3 | £247.23 |
| O225072 | 1000 x 410 x 1200 | 2 | £183.18 |
| O225073 | 1000 x 410 x 1000 | 2 | £160.13 |
| O225074 | 1000 x 410 x 740 | 1 | £154.36 |
| O225075* | 1000 x 410 x 740 | 1 | £154.36 |

*Supplied with shallow base to allow for 2 rows of lever arch files



2 Door Cupboard

- Locking, 2 Keys

| | W x D x H(mm) | Adjustable Shelves | |
|----------|-------------------|--------------------|---------|
| O225081 | 800 x 410 x 2000 | 4 | £399.67 |
| O225082 | 800 x 410 x 1800 | 3 | £371.49 |
| O225083 | 800 x 410 x 1600 | 3 | £341.39 |
| O225084 | 800 x 410 x 1200 | 2 | £281.18 |
| O225085 | 800 x 410 x 1000 | 2 | £252.36 |
| O225086 | 800 x 410 x 740 | 1 | £218.41 |
| O225087* | 800 x 410 x 740 | 1 | £218.41 |
| O225088 | 1000 x 410 x 2000 | 4 | £463.08 |
| O225089 | 1000 x 410 x 1800 | 3 | £426.57 |
| O225091 | 1000 x 410 x 1600 | 3 | £391.35 |
| O225092 | 1000 x 410 x 1200 | 2 | £319.61 |
| O225093 | 1000 x 410 x 1000 | 2 | £282.46 |
| O225094 | 1000 x 410 x 740 | 1 | £247.23 |
| O225095* | 1000 x 410 x 740 | 1 | £247.23 |

*Supplied with shallow base to allow for 2 rows of lever arch files



Filing Cabinet

- 25mm top. Supplied assembled
- Locking, 2 Keys
- Anti-tilt mechanism
- 100% drawer opening
- 15kg safe hanging weight limit per drawer

| | W x D x H(mm) | | |
|---------|------------------|----------|---------|
| O225111 | 484 x 658 x 740 | 2 Drawer | £224.18 |
| O225112 | 484 x 658 x 1048 | 3 Drawer | £299.75 |
| O225113 | 484 x 658 x 1360 | 4 Drawer | £372.77 |



Wood Finishes



CALL US ON 01527 878348



VISIT WWW.FORWARDPRODUCTS.CO.UK



System Storage Cupboard

- 25mm top, supplied assembled
- Locking, 2 keys
- Supplied empty, accepts Bisley accessories from page 203

| | W x D x H(mm) | |
|---------|------------------|---------|
| O225121 | 955 x 580 x 740 | £257.48 |
| O225122 | 955 x 580 x 1000 | £288.23 |
| O225123 | 955 x 580 x 1200 | £326.01 |
| O225124 | 955 x 580 x 1600 | £365.73 |
| O225125 | 955 x 580 x 1800 | £417.61 |
| O225126 | 955 x 580 x 2000 | £461.16 |

Sienna storage units are made in the UK with a 10 year warranty and are supplied fully assembled



System Storage Tambour Cupboard

- Locking, 2 Keys
- Supplied empty, accepts Bisley accessories from page 203
- Silver tambour doors

| | W x D x H(mm) | |
|---------|-------------------|---------|
| O225131 | 1100 x 531 x 740 | £342.67 |
| O225132 | 1100 x 531 x 1000 | £386.22 |
| O225133 | 1100 x 531 x 1200 | £432.34 |
| O225134 | 1100 x 531 x 1600 | £474.61 |
| O225135 | 1100 x 531 x 1800 | £518.81 |
| O225136 | 1100 x 531 x 2000 | £560.44 |



Contract Tambour Cupboard

- 25mm top
- Locking, 2 keys
- Includes wooden shelves
- Silver tambour doors

| | W x D x H(mm) | Adjustable Shelves | |
|---------|-------------------|--------------------|---------|
| O225141 | 1050 x 600 x 1139 | 2 | £452.19 |
| O225142 | 1050 x 600 x 1539 | 3 | £500.87 |
| O225143 | 1050 x 600 x 1739 | 3 | £563.64 |
| O225144 | 1050 x 600 x 1939 | 4 | £601.43 |

Wood Finishes



Glass Shelf

- Please state which unit shelves are for when ordering

| | |
|---------|--------|
| O225151 | £48.04 |
|---------|--------|

Wooden Shelf

- Please state which unit shelves are for when ordering

| | |
|---------|--------|
| O225161 | £35.23 |
|---------|--------|

Bisley Slotted Shelf

- Fits into System storage units on page 202
- Shelf dividers come in a pack of 5

| | | |
|---------|----------|--------|
| O225171 | Shelf | £38.43 |
| O225172 | Dividers | £41.63 |

Bisley Standard Metal Shelf

- Sold in Silver as standard
- Fits into System storage units on page 202

| | |
|---------|--------|
| O225181 | £27.54 |
|---------|--------|

Bisley Wardrobe Shelf Rail

- Sold in Silver as standard
- Hanging rail sits under shelf
- Fits into System storage units on page 202

| | |
|---------|--------|
| O225191 | £48.04 |
|---------|--------|

Bisley Lateral Filing Rail

- Fits into System storage units on page 202

| | |
|---------|--------|
| O225211 | £31.38 |
|---------|--------|

Bisley Roll Out Suspension Filing Frame

- Fits into System storage units on page 202
- Foolscap or 2 rows of A4
- Includes anti-tilt

| | |
|---------|---------|
| O225221 | £108.24 |
|---------|---------|

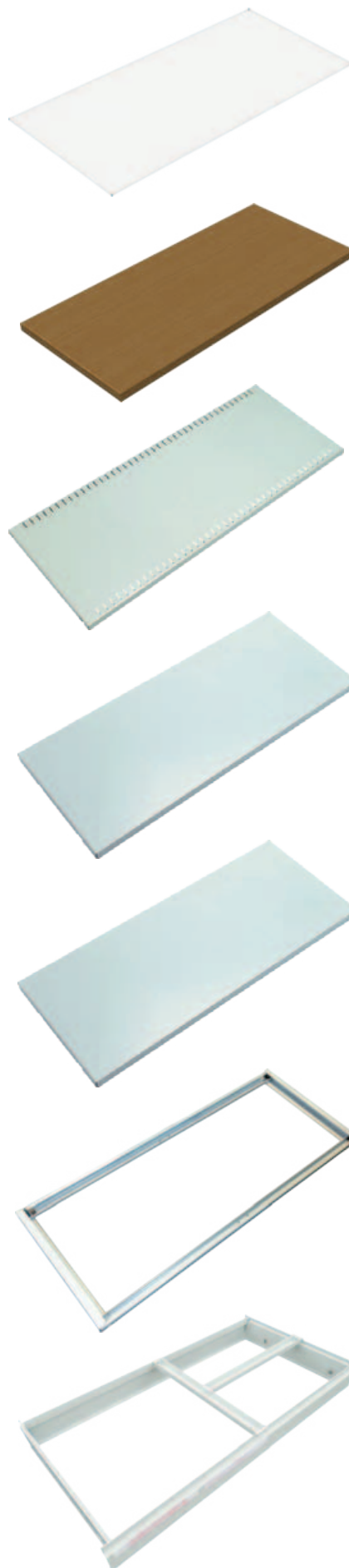



Circular Meeting Table

| | W x D x H(mm) | |
|---------|-------------------|---------|
| O225231 | 800 x 800 x 740 | £298.47 |
| O225232 | 900 x 900 x 740 | £315.77 |
| O225233 | 1000 x 1000 x 740 | £339.47 |
| O225234 | 1200 x 1200 x 740 | £377.25 |
| O225235 | 1600 x 1600 x 740 | £477.81 |



Square Meeting Table

| | W x D x H(mm) | |
|---------|-------------------|---------|
| O225241 | 800 x 800 x 740 | £298.47 |
| O225242 | 900 x 900 x 740 | £315.77 |
| O225243 | 1000 x 1000 x 740 | £339.47 |
| O225244 | 1200 x 1200 x 740 | £377.25 |
| O225245 | 1600 x 1600 x 740 | £477.81 |

Wood Finishes



Metalwork Finishes - Silver supplied if not specified

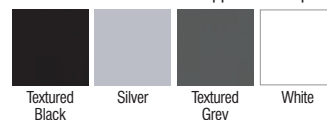



Circular Table - Trumpet Base

| | W x D x H(mm) | |
|---------|-------------------|---------|
| O225251 | 800 x 800 x 740 | £223.53 |
| O225252 | 1000 x 1000 x 740 | £242.11 |
| O225253 | 1200 x 1200 x 740 | £264.53 |
| O225254 | 1400 x 1400 x 740 | £301.68 |

Sienna tables are made in the UK with a 10 year warranty and are supplied fully assembled



Circular Table Crucifix Base

| | W x D x H(mm) | |
|---------|-------------------|---------|
| O225261 | 800 x 800 x 740 | £210.08 |
| O225262 | 900 x 900 x 740 | £219.69 |
| O225263 | 1000 x 1000 x 740 | £237.63 |
| O225264 | 1200 x 1200 x 740 | £264.53 |
| O225265 | 1600 x 1600 x 740 | £427.21 |



CALL US ON 01527 878348



VISIT WWW.FORWARDPRODUCTS.CO.UK



40mm Welded Sienna Training Tables

Our 40mm fully welded training tables are built to withstand rigorous use in the most demanding environments.

- 40mm diameter fully welded frame
- Frames are supplied with adjustable feet

Wood Finishes



Metalwork Finishes - Silver supplied if not specified

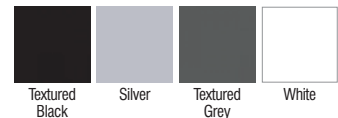

Sienna Rectangular Welded Table

| | W x D x H(mm) | |
|---------|------------------|---------|
| O225271 | 800 x 800 x 400 | £119.13 |
| O225272 | 800 x 800 x 740 | £125.54 |
| O225273 | 1000 x 800 x 740 | £139.63 |
| O225274 | 1200 x 800 x 740 | £144.75 |
| O225275 | 1400 x 800 x 740 | £148.60 |
| O225276 | 1600 x 800 x 740 | £152.44 |
| O225277 | 1800 x 800 x 740 | £168.45 |
| O225278 | 800 x 600 x 740 | £121.70 |
| O225279 | 1000 x 600 x 740 | £134.51 |
| O225281 | 1200 x 600 x 740 | £138.99 |
| O225282 | 1400 x 600 x 740 | £144.75 |
| O225283 | 1600 x 600 x 740 | £147.96 |
| O225284 | 1800 x 600 x 740 | £162.69 |



Sienna Circular Welded Table

| | W x D x H(mm) | |
|---------|-------------------|---------|
| O225291 | 800 x 800 x 740 | £194.71 |
| O225292 | 1000 x 1000 x 740 | £204.96 |
| O225293 | 1200 x 1200 x 740 | £222.89 |



Sienna tables are made in the UK with a 10 year warranty and are supplied fully assembled

Sienna Semi-Circular Welded Table

| | W x D x H(mm) | |
|---------|------------------|---------|
| O225311 | 1200 x 600 x 740 | £186.39 |
| O225312 | 1600 x 800 x 740 | £208.80 |



Sienna Trapezoidal Welded Table

| | W x D x H(mm) | |
|---------|---------------|---------|
| O225321 | 1200 693 740 | £186.39 |
| O225322 | 1600 693 740 | £208.80 |





Sienna Rectangular Tubular Leg Table

- Robust design with 80mm tubular legs

| | W x D x H(mm) | |
|---------|------------------|---------|
| O225331 | 800 x 800 x 740 | £201.12 |
| O225332 | 1000 x 800 x 740 | £205.60 |
| O225333 | 1200 x 800 x 740 | £212.01 |
| O225334 | 1400 x 800 x 740 | £223.53 |
| O225335 | 1600 x 800 x 740 | £234.42 |
| O225336 | 1800 x 800 x 740 | £256.84 |
| O225337 | 800 x 600 x 740 | £178.06 |
| O225338 | 1000 x 600 x 740 | £182.54 |
| O225339 | 1200 x 600 x 740 | £185.10 |
| O225341 | 1400 x 600 x 740 | £200.48 |
| O225342 | 1600 x 600 x 740 | £210.72 |
| O225343 | 1800 x 600 x 740 | £232.50 |

Sienna tables are made in the UK with a 10 year warranty and are supplied fully assembled



Sienna Circular Tubular Leg Table

- Robust design with 80mm tubular legs

| | W x D x H(mm) | |
|---------|-------------------|---------|
| O225351 | 800 x 800 x 740 | £252.36 |
| O225352 | 900 x 900 x 740 | £269.65 |
| O225353 | 1000 x 1000 x 740 | £292.07 |
| O225354 | 1200 x 1200 x 740 | £328.58 |
| O225355 | 1600 x 1600 x 740 | £426.57 |



Sienna Foldaway Table

- Chrome legs as standard

| | W x D x H(mm) | |
|---------|------------------|---------|
| O225361 | 1400 x 800 x 740 | £233.14 |
| O225362 | 1600 x 800 x 740 | £249.15 |
| O225363 | 1800 x 800 x 740 | £270.93 |

Wood Finishes



Metalwork Finishes - Silver supplied if not specified

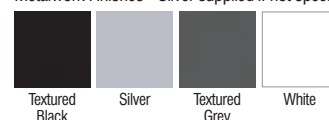

Sienna Rectangular Flip Top Table

- Supplied with lockable castors

| | W x D x H(mm) | |
|---------|------------------|---------|
| O225371 | 800 x 800 x 740 | £273.49 |
| O225372 | 1000 x 800 x 740 | £282.46 |
| O225373 | 1200 x 800 x 740 | £292.07 |
| O225374 | 1400 x 800 x 740 | £303.60 |
| O225375 | 1600 x 800 x 740 | £313.85 |
| O225376 | 1800 x 800 x 740 | £325.37 |
| O225377 | 800 x 600 x 740 | £259.40 |
| O225378 | 1000 x 600 x 740 | £267.09 |
| O225379 | 1200 x 600 x 740 | £275.42 |
| O225381 | 1400 x 600 x 740 | £288.23 |
| O225382 | 1600 x 600 x 740 | £299.11 |
| O225383 | 1800 x 600 x 740 | £307.44 |



Sienna Trapezoidal Flip Top Table

- 800mm ends
- Supplied with lockable castors

| | W x D x H(mm) | |
|---------|------------------|---------|
| O225391 | 1600 x 800 x 740 | £374.69 |



Sienna Semi Circular Flip Top Table

- Supplied with lockable castors

| | W x D x H(mm) | |
|---------|------------------|---------|
| O225411 | 1600 x 800 x 740 | £374.69 |
| O225412 | 1800 x 900 x 740 | £385.58 |



Sienna Rectangular Flip Top Table

- Supplied with lockable castors
- Matt black frame with polished alloy foot

| | W x D x H(mm) | |
|---------|------------------|---------|
| O225421 | 1200 x 800 x 720 | £331.14 |
| O225422 | 1400 x 800 x 720 | £348.43 |
| O225423 | 1600 x 800 x 720 | £356.76 |
| O225424 | 1800 x 800 x 720 | £364.44 |





Sienna Rio Rectangular Boardroom Table

- Cutting edge design with solid European oak legs to create the right impression in your meeting room
- Sienna Rio boardroom tables are made in the UK with a 10 year warranty and come in a wide range of stylish wood finishes
- Solid European Oak legs
- 2 piece tables will be supplied with 2 tops & 1 leg frame (with central support legs)

| | W x D x H(mm) | Top | |
|---------|-------------------|---------|----------|
| O225431 | 2000 x 1200 x 740 | 1-Piece | £883.25 |
| O225432 | 2400 x 1200 x 740 | 1-Piece | £951.14 |
| O225433 | 2600 x 1200 x 740 | 1-Piece | £1018.40 |
| O225434 | 2800 x 1200 x 740 | 1-Piece | £1223.36 |
| O225435 | 3000 x 1200 x 740 | 2-Piece | £1257.94 |
| O225436 | 3200 x 1200 x 740 | 2-Piece | £1325.19 |
| O225437 | 3400 x 1200 x 740 | 2-Piece | £1392.45 |
| O225438 | 3600 x 1200 x 740 | 2-Piece | £1460.34 |
| O225439 | 3800 x 1200 x 740 | 2-Piece | £1527.59 |
| O225441 | 4000 x 1200 x 740 | 2-Piece | £1597.41 |

(Please note that like real woodgrain the MFC grain may not line up exactly on the 2-Piece tops)

Top Finishes





Sienna Rio Rectangular Boardroom Table

- Sleek design with square steel legs to impress staff and visitors
- Sienna Rio boardroom tables are made in the UK with a 10 year warranty and come in a wide range of stylish wood finishes

| | W x D x H(mm) | Top | |
|---------|-------------------|---------|----------|
| O225451 | 2000 x 1200 x 740 | 1-Piece | £618.08 |
| O225452 | 2400 x 1200 x 740 | 1-Piece | £694.94 |
| O225453 | 2600 x 1200 x 740 | 1-Piece | £771.80 |
| O225454 | 2800 x 1200 x 740 | 2-Piece | £810.87 |
| O225455 | 3000 x 1200 x 740 | 2-Piece | £849.94 |
| O225456 | 3200 x 1200 x 740 | 2-Piece | £926.16 |
| O225457 | 3400 x 1200 x 740 | 2-Piece | £1003.02 |
| O225458 | 3600 x 1200 x 740 | 2-Piece | £1079.88 |
| O225459 | 3800 x 1200 x 740 | 2-Piece | £1156.74 |
| O225461 | 4000 x 1200 x 740 | 2-Piece | £1236.17 |

(Please note that like real woodgrain the MFC grain may not line up exactly on the 2-Piece tops)



Wood Finishes



Metalwork Finishes - Silver supplied if not specified

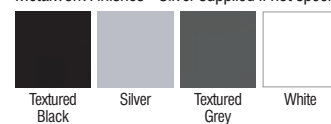

CALL US ON 01527 878348



VISIT WWW.FORWARDPRODUCTS.CO.UK



Sienna Riviera Boardroom Tables

- Create a stylish and airy environment in your meeting room!
- Sienna Riviera boardroom tables are made in the UK with a 10 year warranty and come in a wide range of stylish wood finishes
- Available with rectangular tops, or with shaped tops in 3 different styles, please specify when ordering
- 2800mm - 4000mm tables will be supplied with 2 tops, 2 leg frames and 2 pairs of connecting plates

Rectangular Boardroom Table



| | W x D x H(mm) | Top | |
|---------|-------------------|---------|----------|
| O225471 | 2000 x 1200 x 740 | 1-Piece | £512.40 |
| O225472 | 2400 x 1200 x 740 | 1-Piece | £580.93 |
| O225473 | 2600 x 1200 x 740 | 1-Piece | £661.00 |
| O225474 | 2800 x 1200 x 740 | 2-Piece | £700.71 |
| O225475 | 3000 x 1200 x 740 | 2-Piece | £737.22 |
| O225476 | 3200 x 1200 x 740 | 2-Piece | £786.53 |
| O225477 | 3400 x 1200 x 740 | 2-Piece | £835.21 |
| O225478 | 3600 x 1200 x 740 | 2-Piece | £885.81 |
| O225479 | 3800 x 1200 x 740 | 2-Piece | £1005.59 |
| O225481 | 4000 x 1200 x 740 | 2-Piece | £1050.42 |

(Please note that like real woodgrain the MFC grain may not line up exactly on the 2-Piece tops)

Shaped Boardroom Table

- State required shape with order - Oval, D End or Boat options available



| | W x D x H(mm) | Top | |
|---------|-------------------|---------|----------|
| O225491 | 2000 x 1200 x 740 | 1-Piece | £643.70 |
| O225492 | 2400 x 1200 x 740 | 1-Piece | £674.45 |
| O225493 | 2600 x 1200 x 740 | 1-Piece | £801.91 |
| O225494 | 2800 x 1200 x 740 | 2-Piece | £866.60 |
| O225495 | 3000 x 1200 x 740 | 2-Piece | £930.01 |
| O225496 | 3200 x 1200 x 740 | 2-Piece | £1005.59 |
| O225497 | 3400 x 1200 x 740 | 2-Piece | £1050.42 |
| O225498 | 3600 x 1200 x 740 | 2-Piece | £1112.55 |
| O225499 | 3800 x 1200 x 740 | 2-Piece | £1270.11 |
| O225511 | 4000 x 1200 x 740 | 2-Piece | £1332.88 |

(Please note that like real woodgrain the MFC grain may not line up exactly on the 2-Piece tops)



'D' D End

'BS' Boat Shaped

'O' Oval

Top Finishes



Metalwork Finishes - Silver supplied if not specified

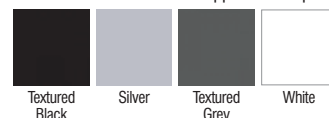

Sienna Vienna Boardroom Tables

- Smart and durable, Vienna boardroom tables provide an inexpensive and professional meeting environment
- Sienna Vienna boardroom tables are made in the UK with a 10 year warranty and come in a wide range of stylish wood finishes
- 2800mm, 3000mm, 3200mm & 3400mm tables will be supplied with 2 tops, 1 leg frame & 2 supporting bars
- 3600mm - 4000mm tables will be supplied with 2 tops, 2 leg frames and 2 pairs of fish plates



Rectangular Boardroom Table

| | W x D x H(mm) | Top | |
|---------|-------------------|---------|---------|
| O225521 | 2000 x 1200 x 740 | 1-Piece | £399.67 |
| O225522 | 2400 x 1200 x 740 | 1-Piece | £459.88 |
| O225523 | 2600 x 1200 x 740 | 1-Piece | £525.21 |
| O225524 | 2800 x 1200 x 740 | 2-Piece | £559.16 |
| O225525 | 3000 x 1200 x 740 | 2-Piece | £593.10 |
| O225526 | 3200 x 1200 x 740 | 2-Piece | £639.22 |
| O225527 | 3400 x 1200 x 740 | 2-Piece | £689.18 |
| O225528 | 3600 x 1200 x 740 | 2-Piece | £737.22 |
| O225529 | 3800 x 1200 x 740 | 2-Piece | £872.36 |
| O225531 | 4000 x 1200 x 740 | 2-Piece | £930.01 |

(Please note that like real woodgrain the MFC grain may not line up exactly on the 2-Piece tops)



Shaped Boardroom Table

- State required shape with order - Oval, D End or Boat options available

| | W x D x H(mm) | Top | |
|---------|-------------------|---------|----------|
| O225541 | 2000 x 1200 x 740 | 1-Piece | £546.99 |
| O225542 | 2400 x 1200 x 740 | 1-Piece | £582.21 |
| O225543 | 2600 x 1200 x 740 | 1-Piece | £684.05 |
| O225544 | 2800 x 1200 x 740 | 2-Piece | £735.29 |
| O225545 | 3000 x 1200 x 740 | 2-Piece | £786.53 |
| O225546 | 3200 x 1200 x 740 | 2-Piece | £850.58 |
| O225547 | 3400 x 1200 x 740 | 2-Piece | £907.59 |
| O225548 | 3600 x 1200 x 740 | 2-Piece | £979.97 |
| O225549 | 3800 x 1200 x 740 | 2-Piece | £1147.78 |
| O225551 | 4000 x 1200 x 740 | 2-Piece | £1197.74 |

(Please note that like real woodgrain the MFC grain may not line up exactly on the 2-Piece tops)



Wood Finishes



CALL US ON 01527 878348



VISIT WWW.FORWARDPRODUCTS.CO.UK



Sienna Barcelona Boardroom Tables

- Add some design flair to your meeting room with a Sienna Barcelona table
- The curved leg and modesty panel design adds visual interest, specify different panel colours to take this to the next level!
- Sienna furniture is made in the UK and carries a 10 year warranty
- 2800mm, 3000mm, 3200mm & 3400mm tables will be supplied with 2 tops, 1 leg frame & 2 supporting bars
- 3600mm - 4000mm tables will be supplied with 2 tops, 2 leg frames and 2 pairs of fish plates



'D' D End

'BS' Boat Shaped

'O' Oval

Top Finishes



Rectangular Boardroom Table

| | W x D x H(mm) | Top | |
|----------|-------------------|---------|----------|
| O225561 | 2000 x 1200 x 740 | 1-Piece | £487.42 |
| O225562 | 2400 x 1200 x 740 | 1-Piece | £553.39 |
| O225563 | 2600 x 1200 x 740 | 1-Piece | £614.88 |
| O225564* | 2800 x 1200 x 740 | 2-Piece | £645.62 |
| O225565* | 3000 x 1200 x 740 | 2-Piece | £676.37 |
| O225566* | 3200 x 1200 x 740 | 2-Piece | £738.50 |
| O225567* | 3400 x 1200 x 740 | 2-Piece | £800.63 |
| O225568* | 3600 x 1200 x 740 | 2-Piece | £860.83 |
| O225569* | 3800 x 1200 x 740 | 2-Piece | £949.86 |
| O225571* | 4000 x 1200 x 740 | 2-Piece | £1036.33 |

(Please note that like real woodgrain the MFC grain may not line up exactly on the 2-Piece tops)

Shaped Boardroom Table

- State required shape with order - Oval, D End or Boat options available

| | W x D x H(mm) | Top | |
|----------|-------------------|---------|----------|
| O225581 | 2000 x 1200 x 740 | 1-Piece | £612.96 |
| O225582 | 2400 x 1200 x 740 | 1-Piece | £641.78 |
| O225583 | 2600 x 1200 x 740 | 1-Piece | £718.64 |
| O225584* | 2800 x 1200 x 740 | 2-Piece | £755.15 |
| O225585* | 3000 x 1200 x 740 | 2-Piece | £792.94 |
| O225586* | 3200 x 1200 x 740 | 2-Piece | £870.44 |
| O225587* | 3400 x 1200 x 740 | 2-Piece | £945.38 |
| O225588* | 3600 x 1200 x 740 | 2-Piece | £1020.96 |
| O225589* | 3800 x 1200 x 740 | 2-Piece | £1097.82 |
| O225591* | 4000 x 1200 x 740 | 2-Piece | £1227.20 |

(Please note that like real woodgrain the MFC grain may not line up exactly on the 2-Piece tops)





Sienna Panel End Boardroom Tables

- With a fantastic range of shapes and sizes, Sienna Panel End boardroom tables offer the perfect balance of style and value
- Sienna boardroom tables are made in the UK and carry a 10 year warranty
- 2800mm, 3000mm, 3200mm & 3400mm tables will be supplied with 2 tops, 1 leg frame & 2 supporting bars
- 3600mm - 4000mm tables will be supplied with 2 tops, 2 leg frames and 2 pairs of fish plates

Rectangular Boardroom Table

| | W x D x H(mm) | Top | |
|----------|-------------------|---------|---------|
| O225611 | 2000 x 1200 x 740 | 1-Piece | £399.67 |
| O225612 | 2400 x 1200 x 740 | 1-Piece | £459.88 |
| O225613 | 2600 x 1200 x 740 | 1-Piece | £525.21 |
| O225614* | 2800 x 1200 x 740 | 2-Piece | £559.16 |
| O225615* | 3000 x 1200 x 740 | 2-Piece | £593.10 |
| O225616* | 3200 x 1200 x 740 | 2-Piece | £639.22 |
| O225617* | 3400 x 1200 x 740 | 2-Piece | £689.18 |
| O225618* | 3600 x 1200 x 740 | 2-Piece | £737.22 |
| O225619* | 3800 x 1200 x 740 | 2-Piece | £872.36 |
| O225621* | 4000 x 1200 x 740 | 2-Piece | £930.01 |

(Please note that like real woodgrain the MFC grain may not line up exactly on the 2-Piece tops)



Shaped Boardroom Table

- State required shape with order - Oval, D End or Boat options available

| | W x D x H(mm) | Top | |
|----------|-------------------|---------|----------|
| O225631 | 2000 x 1200 x 740 | 1-Piece | £546.99 |
| O225632 | 2400 x 1200 x 740 | 1-Piece | £582.21 |
| O225633 | 2600 x 1200 x 740 | 1-Piece | £684.05 |
| O225634* | 2800 x 1200 x 740 | 2-Piece | £735.29 |
| O225635* | 3000 x 1200 x 740 | 2-Piece | £786.53 |
| O225636* | 3200 x 1200 x 740 | 2-Piece | £850.58 |
| O225637* | 3400 x 1200 x 740 | 2-Piece | £907.59 |
| O225638* | 3600 x 1200 x 740 | 2-Piece | £979.97 |
| O225639* | 3800 x 1200 x 740 | 2-Piece | £1147.78 |
| O225641* | 4000 x 1200 x 740 | 2-Piece | £1197.74 |

(Please note that like real woodgrain the MFC grain may not line up exactly on the 2-Piece tops)



'D' D End



'BS' Boat Shaped



'O' Oval



CALL US ON 01527 878348



VISIT WWW.FORWARDPRODUCTS.CO.UK



Sienna Trumpet Base Coffee Tables

- Stylish trumpet base design with a robust 25mm MFC top
- Supplied with stainless steel base as standard - otherwise please specify powder coat colour from below options
- Made in the UK with a 10 year warranty

Circular

| | W x D x H(mm) | |
|---------|-----------------|---------|
| O225651 | 600 x 600 x 465 | £155.00 |
| O225652 | 700 x 700 x 465 | £163.33 |
| O225653 | 800 x 800 x 465 | £172.94 |

Curved Square

| | W x D x H(mm) | |
|---------|-----------------|---------|
| O225661 | 600 x 600 x 465 | £155.00 |
| O225662 | 700 x 700 x 465 | £163.33 |
| O225663 | 800 x 800 x 465 | £172.94 |

Square

| | W x D x H(mm) | |
|---------|-----------------|---------|
| O225671 | 600 x 600 x 465 | £131.94 |
| O225672 | 700 x 700 x 465 | £139.63 |
| O225673 | 800 x 800 x 465 | £149.88 |

Rectangular

| | W x D x H(mm) | |
|---------|------------------|---------|
| O225681 | 800 x 600 x 465 | £139.63 |
| O225682 | 900 x 500 x 465 | £139.63 |
| O225683 | 1200 x 600 x 465 | £263.25 |

Top Finishes



Metalwork Finishes - Stainless Steel supplied if not specified





Sienna Hairpin Leg Coffee Tables

- A modern classic, hairpin legs add elegance to your breakout areas!
- Frames come in black only, with a wide range of wood finishes
- Made in the UK with 10 year warranty
- Available with black frame only

Circular

| | W x D x H(mm) | |
|---------|-----------------|---------|
| O225691 | 600 x 600 x 410 | £155.00 |
| O225692 | 700 x 700 x 410 | £163.33 |
| O225693 | 800 x 800 x 410 | £172.94 |

Curved Square

| | W x D x H(mm) | |
|---------|-----------------|---------|
| O225711 | 600 x 600 x 410 | £155.00 |
| O225712 | 700 x 700 x 410 | £163.33 |
| O225713 | 800 x 800 x 410 | £172.94 |

Square

| | W x D x H(mm) | |
|---------|-----------------|---------|
| O225721 | 600 x 600 x 410 | £131.94 |
| O225722 | 700 x 700 x 410 | £139.63 |
| O225723 | 800 x 800 x 410 | £149.88 |

Rectangular

| | W x D x H(mm) | |
|---------|------------------|---------|
| O225731 | 800 x 600 x 410 | £139.63 |
| O225732 | 900 x 500 x 410 | £139.63 |
| O225733 | 1200 x 600 x 410 | £196.63 |

Top Finishes



CALL US ON 01527 878348



VISIT WWW.FORWARDPRODUCTS.CO.UK



Sienna Tubular Leg Coffee Tables

- Robust tubular legs and 25mm MFC top
- Available in a wide range of colours
- Made in the UK with a 10 year warranty

Circular

| | W x D x H(mm) | |
|---------|-----------------|---------|
| O225741 | 600 x 600 x 400 | £155.00 |
| O225742 | 700 x 700 x 400 | £163.33 |
| O225743 | 800 x 800 x 400 | £172.94 |

Curved Square

| | W x D x H(mm) | |
|---------|-----------------|---------|
| O225751 | 600 x 600 x 400 | £155.00 |
| O225752 | 700 x 700 x 400 | £163.33 |
| O225753 | 800 x 800 x 400 | £172.94 |

Square

| | W x D x H(mm) | |
|---------|-----------------|---------|
| O225761 | 600 x 600 x 400 | £131.94 |
| O225762 | 700 x 700 x 400 | £139.63 |
| O225763 | 800 x 800 x 400 | £149.88 |

Rectangular

| | W x D x H(mm) | |
|---------|------------------|---------|
| O225771 | 800 x 600 x 400 | £139.63 |
| O225772 | 900 x 500 x 400 | £139.63 |
| O225773 | 1200 x 600 x 400 | £196.63 |

Top Finishes



Metalwork Finishes - Silver supplied if not specified



Signature Tables

- Funky range of two tier tables
- Mixture of clear and frosted glass for unique looks
- Polished chrome legs
- Toughened glass tops

| | | |
|---------|---|---------|
| S211481 | Boat Shaped Table W1190 x D690 x H450mm | £247.03 |
| S211482 | Shield Shaped Table W890 x D890 x H450mm | £240.45 |
| S211483 | Square Table W700 x H450mm | £268.80 |
| S211484 | Rectangular Table W1200 x D600 x H465mm | £324.79 |



Signature Boat Table



Signature Shield Table



Signature Square Table

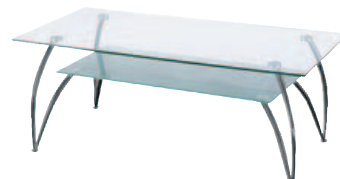

Signature Rectangular Table



Crystal Circular

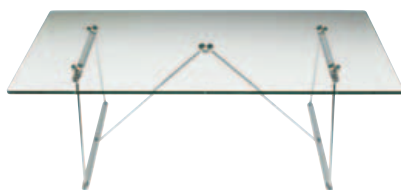

Crystal Rectangular

Crystal Tables

- Stylish clear glass tables
- Silver and brushed steel bases
- Toughened glass tops

| | | |
|---------|--------------------------------------|---------|
| S211491 | Circular D500 x H590mm | £213.03 |
| S211492 | Rectangular W1200 x D600 x H420mm | £277.43 |

Please see Important Furniture Ordering Information on page 3 before placing your furniture order

Shimmer Tables

- Classic glass top coffee tables
- Chrome legs
- Toughened clear glass tops

| | | |
|---------|-------------------------------------|---------|
| S211511 | Rectangular W900 x D500 x H340mm | £240.09 |
| S211512 | Square W500 x H340mm | £185.07 |



Shimmer Rectangular



Shimmer Square



CALL US ON 01527 878348



VISIT WWW.FORWARDPRODUCTS.CO.UK



Our
Express Furniture
is available for
rapid delivery in
only 1-2 days!



10

Express Furniture

| | |
|-----------------------------|-----|
| Office Seating | 222 |
| Cantilever Desks | 223 |
| Panel End Desks | 224 |
| Pedestals & Filing Cabinets | 225 |
| Bookcases & Filing Cabinets | 226 |
| Steel Storage | 227 |

Express Range

- 1-2 day delivery
- Desks and wooden cupboards delivered flat packed
- Desks and wooden storage available in four top finishes and two frame finishes
- **Please see Important Furniture Ordering Information on page 3 before placing your furniture order**



Express Meeting Chairs

- Cushioned seat and back for added comfort
- Robust black or chrome frame options
- 5 year component guarantee and 2 year upholstery guarantee
- Available in 6 upholstery colours

| | | |
|---------|-------------------|--------|
| X211111 | With Black Frame | £46.28 |
| X211112 | With Chrome Frame | £47.58 |



+ Now available in anti-microbial woven fabric, effective against Covid-19 see page 262



Express Extra Comfort Chair

- Deep cushioned seat and back in a tough wearing fabric
- Physio approved ergonomic features
- Height adjustable arms, ratchet back, inflatable lumbar support and seat slide
- 5 year component guarantee and 2 year upholstery guarantee
- Available in Royal Blue or Charcoal as standard

| | | |
|---------|---------------------|---------|
| X211131 | Extra Comfort Chair | £246.48 |
|---------|---------------------|---------|

Express Operator Chairs

- Deep cushioned seat and back in a tough wearing fabric
- Fixed back for maximum strength
- 2 year guarantee
- Available in 6 upholstery colours

| | | |
|---------|----------------------|---------|
| X211121 | Without Arms | £79.54 |
| X211122 | With Fixed Arms | £102.44 |
| X211123 | With Adjustable Arms | £118.51 |

Express Chair Fabric Options

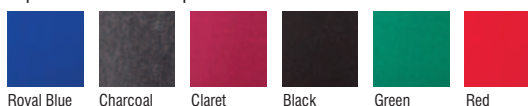



Express Cantilever Desks

- Cost effective cantilever leg workstation range
- 25mm thick tops
- 5 year guarantee
- Available in 4 top colours and 2 frame colours – please specify when ordering
- Supplied flat packed for self-assembly
- **Please see Important Furniture Ordering Information on page 3 before placing your furniture order**

Top Finishes



Beech

Oak

White

Grey Oak

Frame Finishes



White

Silver



Crescent Desks (right hand pictured)

| | | |
|---------|-------------------------------|---------|
| X211173 | Left W1600/1200 x D800/600mm | £196.25 |
| X211174 | Right W1600/1200 x D800/600mm | £196.25 |
| X211175 | Left W1800/1200 x D800/600mm | £256.72 |
| X211176 | Right W1800/1200 x D800/600mm | £256.72 |



Supplied
flat-packed
in just
1-2 days



600mm Deep Rectangular Desks

| | | |
|---------|----------------|---------|
| X211141 | W800 x D600mm | £118.98 |
| X211142 | W1200 x D600mm | £145.86 |
| X211143 | W1400 x D600mm | £161.98 |
| X211144 | W1600 x D600mm | £174.72 |
| X211145 | W1800 x D600mm | £192.19 |

800mm Deep Rectangular Desks

| | | |
|---------|----------------|---------|
| X211151 | W800 x D800mm | £123.66 |
| X211152 | W1200 x D800mm | £152.57 |
| X211153 | W1400 x D800mm | £174.72 |
| X211154 | W1600 x D800mm | £181.48 |
| X211155 | W1800 x D800mm | £200.30 |



CALL US ON 01527 878348



VISIT WWW.FORWARDPRODUCTS.CO.UK



Supplied flat-packed in just 1-2 days

Express Panel End Desks

- Contemporary panel end workstation range
- 25mm thick tops
- 5 year guarantee
- Available in 4 top colours – please specify when ordering
- Supplied flat packed for self-assembly
- **Please see Important Furniture Ordering Information on page 3 before placing your furniture order**



600mm Deep Rectangular Desks

Top Finishes



Beech Oak White Grey Oak

| | | |
|---------|----------------|---------|
| X211181 | W800 x D600mm | £118.98 |
| X211182 | W1200 x D600mm | £145.86 |
| X211183 | W1400 x D600mm | £168.01 |
| X211184 | W1600 x D600mm | £174.72 |
| X211185 | W1800 x D600mm | £192.19 |



Crescent Desks (left hand pictured)

| | | |
|---------|-------------------------------|---------|
| X211215 | Left W1600/1200 x D800/600mm | £196.25 |
| X211216 | Right W1600/1200 x D800/600mm | £196.25 |
| X211217 | Left W1800/1200 x D800/600mm | £256.72 |
| X211218 | Right W1800/1200 x D800/600mm | £256.72 |



800mm Deep Rectangular Desks

| | | |
|---------|----------------|---------|
| X211191 | W800 x D800mm | £123.66 |
| X211192 | W1200 x D800mm | £152.57 |
| X211193 | W1400 x D800mm | £174.72 |
| X211194 | W1600 x D800mm | £181.48 |
| X211195 | W1800 x D800mm | £200.30 |



Express Wooden Filing

- 5 year guarantee
- Available in 4 colours - please specify when ordering
- **Please see Important Furniture Ordering Information on page 3 before placing your furniture order**

Top Finishes



Delivered
in just
1-2 days



2 Drawer Fixed Pedestal

- Compatible with 800mm deep desks

X211231 W400 x D500 x H495mm £128.39



3 Drawer Fixed Pedestal

- Compatible with 800mm deep desks

X211232 W400 x D500 x H495mm £128.39



2 Drawer Mobile Pedestal

X211233 W404 x D500 x H595mm £131.72



3 Drawer Mobile Pedestal

X211234 W404 x D500 x H595mm £131.72



3 Drawer Under Desk Pedestal

X211235 W404 x D500 x H690mm £185.48



3 Drawer Desk High Pedestal

X211236 W404 x D600 x H730mm £185.48

X211237 W404 x D800 x H730mm £233.22



2 Drawer Filing Cabinet

X211241 W464 x D600 x H710mm £236.55



4 Drawer Filing Cabinet

X211242 W464 x D600 x H1365mm £324.58



Heavy Duty Desk High Side Filer

X211243 W800 x D600 x H730mm £442.21



CALL US ON 01527 878348



VISIT WWW.FORWARDPRODUCTS.CO.UK

Express Wooden Storage

- Please see Important Furniture Ordering Information on page 3 before placing your furniture order



Supplied flat-packed in just 1-2 days



Open Fronted Bookcases

- Adjustable Shelves
- 5 year guarantee

| | | |
|---------|---------------------------------|---------|
| X211251 | 1 Shelf W800 x D450 x H730mm | £121.63 |
| X211253 | 3 Shelves W800 x D450 x H1200mm | £176.07 |
| X211254 | 4 Shelves W800 x D450 x H1800mm | £196.25 |
| X211255 | 5 Shelves W800 x D450 x H2000mm | £216.42 |

Double Door Cupboards

- Adjustable Shelves
- 5 year guarantee

| | | |
|---------|---------------------------------|---------|
| X211261 | 1 Shelf W800 x D450 x H730mm | £162.66 |
| X211263 | 3 Shelves W800 x D450 x H1200mm | £229.84 |
| X211264 | 4 Shelves W800 x D450 x H1800mm | £256.72 |
| X211265 | 5 Shelves W800 x D450 x H2000mm | £284.28 |

Wooden Storage Finishes



Filing Cabinet Finishes

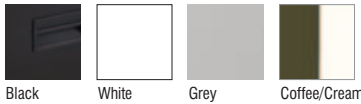

2 Drawer Steel Filing Cabinet

- 465mm wide x 620mm deep
- 7 year guarantee

3 Drawer Steel Filing Cabinet

- 465mm wide x 620mm deep
- 7 year guarantee

4 Drawer Steel Filing Cabinet

- 465mm wide x 620mm deep
- 7 year guarantee

| | | | | | | | | |
|---------|-------------------|---------|---------|--------------------|---------|---------|--------------------|---------|
| X211271 | 2 Drawer - H700mm | £134.58 | X211272 | 3 Drawer - H1000mm | £175.34 | X211273 | 4 Drawer - H1300mm | £187.62 |
|---------|-------------------|---------|---------|--------------------|---------|---------|--------------------|---------|



Express Steel Storage

- 7 year guarantee
- All units lockable
- **Please see Important Furniture Ordering Information on page 3 before placing your furniture order**



Double Door & Tambour Cupboard Finishes



Steel Double Door Cupboards

- Adjustable shelves included
- Lockable doors
- Additional shelves available

| | Shelves | Dimensions (mm) | |
|---------|-------------------------------|---------------------|---------|
| X211281 | 2 | W920 x D420 x H1000 | £166.61 |
| X211282 | 4 | W920 x D420 x H1790 | £229.01 |
| X211283 | 4 | W920 x D420 x H1900 | £251.63 |
| X211284 | Dual purpose adjustable shelf | | £16.59 |



Tambour Cupboards

- Adjustable shelves included
- Lockable doors
- Additional shelves available
- Roll out filing frame available

| Cupboards | Shelves | | |
|-----------|---------|------------------------|---------|
| X211291 | 2 | W1000 x D450 x H1050mm | £333.84 |
| X211292 | 4 | W1000 x D450 x H1950mm | £407.68 |

Accessories

| | | |
|---------|-------------------------------|--------|
| X211293 | Dual purpose adjustable shelf | £23.71 |
| X211294 | Roll out filing frame | £93.81 |



Pedestal Finishes



Steel Mobile 3 Drawer Pedestals

- Standard or slimline (300mm wide) options

| | | |
|---------|----------------------|---------|
| X211311 | W380 x D470 x H615mm | £160.37 |
| X211312 | W300 x D470 x H615mm | £160.37 |



CALL US ON 01527 878348



VISIT WWW.FORWARDPRODUCTS.CO.UK



11

Steel Storage

| | |
|--------------------------|---------|
| Steel Filing Cabinets | 230-231 |
| Steel Storage Cupboards | 232-234 |
| Steel Pedestals | 235 |
| Safes | 236 |
| Fire Resistant Cupboards | 237 |
| Lockers | 238-241 |



Standard Filing Cabinet

- 40kg suspension file carrying capacity per drawer
- 10 year guarantee
- Anti-tilt locking mechanism
- 100% drawer extension
- 458mm wide x 622mm deep
- Standard colours: Light Grey and Coffee Cream
- **Please see Important Furniture Ordering Information on page 3 before placing your furniture order**

| | | |
|---------|------------------------|---------|
| O212971 | 2 Drawer - 711mm High | £112.17 |
| O212972 | 3 Drawer - 1009mm High | £130.86 |
| O212973 | 4 Drawer - 1320mm High | £137.87 |

* Please specify colour when ordering

Standard Colours

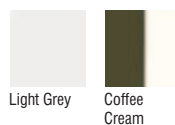

Coloured Filing Cabinet

- 40kg suspension file carrying capacity per drawer
- 10 year guarantee
- Anti-tilt locking mechanism
- 100% drawer extension
- 458mm wide x 622mm deep
- Premium colours available as shown below
- **Please see Important Furniture Ordering Information on page 3 before placing your furniture order**

| | | |
|---------|-----------------------------|---------|
| O212981 | 2 Drawer Coloured - H711mm | £126.36 |
| O212982 | 3 Drawer Coloured - H1009mm | £136.07 |
| O212983 | 4 Drawer Coloured - H1320mm | £153.09 |

* Please specify colour when ordering



Please Specify: Colour

Standard Colours

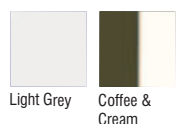

Premium Colours

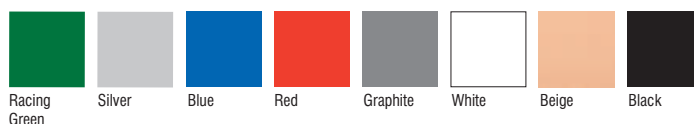

Premium Filing Cabinet

- 40kg suspension file carrying capacity per drawer
- 15 year guarantee
- 100% drawer extension
- Stylish swan neck handle design
- 458mm wide x 622mm deep
- Standard colours: Light Grey and Coffee Cream
- Premium colours available as previous page, price on application
- **Please see Important Furniture Ordering Information on page 3 before placing your furniture order**



| | | |
|---------|------------------------|---------|
| O212991 | 2 Drawer - 711mm High | £127.39 |
| O212992 | 3 Drawer - 1009mm High | £143.90 |
| O212993 | 4 Drawer - 1320mm High | £160.42 |

* Please specify colour when ordering

Standard Colours



Light Grey



Coffee Cream

Premium colours - see previous page, price on application



Multidrawer Storage Units

- Locking and non-locking
- 5 year guarantee
- Smooth running drawers
- Available in Light Grey, Coffee Cream, and Black
- **Please see Important Furniture Ordering Information on page 3 before placing your furniture order**

| | | |
|---------|-----------------------|---------|
| O213111 | 5 Drawer Locking | £88.47 |
| O213112 | 10 Drawer Locking | £128.58 |
| O213113 | 15 Drawer Locking | £181.66 |
| O213114 | 5 Drawer Non Locking | £88.88 |
| O213115 | 10 Drawer Non Locking | £116.78 |
| O213116 | 15 Drawer Non Locking | £163.96 |

* Please specify colour when ordering



CALL US ON 01527 878348



VISIT WWW.FORWARDPRODUCTS.CO.UK



Standard Storage Cupboard

- Two locking doors with strengthener
- 5 year guarantee
- 5 heights available
- 915mm wide x 458mm deep
- Standard colours: Light Grey and Coffee Cream
- Premium colours available to order, price on application
- **Please see Important Furniture Ordering Information on page 3 before placing your furniture order**

| | | |
|---------|-------------|---------|
| O213121 | 690mm High | £156.41 |
| O213122 | 1020mm High | £163.63 |
| O213123 | 1650mm High | £185.29 |
| O213124 | 1830mm High | £188.90 |
| O213125 | 1950mm High | £231.01 |

Cupboards supplied empty - choose accessories from range on page 234



Please Specify:

Colour

Standard Colours

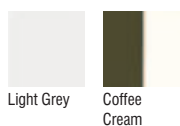

Light Grey

Coffee Cream

Premium Colours

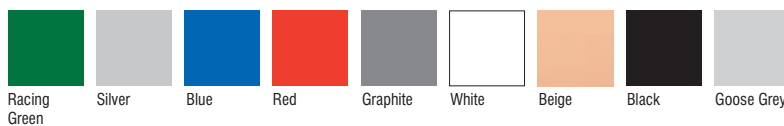

Racing Green

Silver

Blue

Red

Graphite

White

Beige

Black

Goose Grey



Premium Storage Cupboard

- Locking doors with full length reinforcements
- 10 year guarantee
- Security bar option
- 915mm wide x 458mm deep
- Standard colours: Light Grey and Coffee Cream
- Premium colours available to order, price on application
- **Please see Important Furniture Ordering Information on page 3 before placing your furniture order**

| | | |
|---------|-------------|---------|
| O213131 | 1020mm High | £175.04 |
| O213132 | 1830mm High | £200.54 |
| O213133 | 1950mm High | £245.30 |

Cupboards supplied empty - choose accessories from range on page 234



Standard Side Tambour Cupboard

- Magnetic handle strip
- Smooth running track
- 5 year guarantee
- 5 heights available
- 1000mm wide x 507mm deep
- Standard colours: Light Grey and Coffee Cream
- Premium colours available to order as previous page, price on application
- **Please see Important Furniture Ordering Information on page 3 before placing your furniture order**

| | | |
|---------|-------------|---------|
| O213141 | 690mm High | £297.65 |
| O213142 | 1016mm High | £316.76 |
| O213143 | 1320mm High | £337.81 |
| O213144 | 1651mm High | £356.65 |
| O213145 | 2000mm High | £371.80 |

Cupboards supplied empty - choose accessories from range on page 234



Premium Side Tambour Cupboard

- Smooth track glide system
- 15 year guarantee
- 7 heights available
- 1000mm wide x 507mm deep
- Standard carcass colours: Light Grey and Coffee Cream
- Premium colours available to order as previous page, price on application
- Standard tambour colour Grey
- Other colours available to order - Graphite, Silver, Red, Blue and Green - price on application
- **Please see Important Furniture Ordering Information on page 3 before placing your furniture order**

| | | |
|---------|-------------|---------|
| O213151 | 690mm High | £367.01 |
| O213152 | 1016mm High | £404.97 |
| O213153 | 1200mm High | £420.16 |
| O213154 | 1320mm High | £473.01 |
| O213155 | 1651mm High | £509.62 |
| O213156 | 2000mm High | £518.48 |
| O213157 | 2210mm High | £602.67 |

Cupboards supplied empty - choose accessories from range on page 234



The cupboard accessories below can be used inside all storage units on pages 232-233



O213161
Plain Shelf, 330mm Hanging
£16.20



O213162
Wardrobe Shelf
£34.80



O213163
Lateral Filing Frame
£21.64

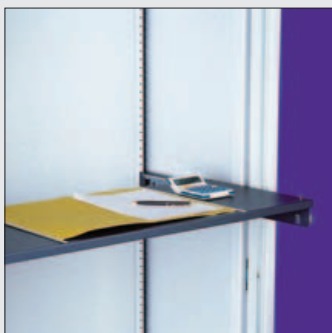

O213164
Roll Out Shelf
£73.98



O213165
Letter Sorter
£143.32



O213166
Roll Out Slotted Drawer
£96.14



O213167
Slotted Shelf
£28.90



O213169
Roll Out Suspension Filing Frame
£73.98

Please see Important Furniture Ordering Information on page 3 before placing your furniture order

NB: Roll-out fittings are only recommended in the bottom half of the unit. Remember to specify anti-tilt with roll-out filing.



Cube Pedestals

- Super strong, smart option for the modern office
- Range includes narrow (300mm) width – ideal for small desks
- Choice of white or silver
- Free drawer dividers and pen tray with every pedestal
- Hidden 5th castor on filing drawer
- Solid Nylon castors (unbreakable)
- 5 year guarantee
- Compact 500mm depth – doesn't clash with large cable trays
- Main colour used inside drawers
- Central locking – free master key with large orders
- **Please see Important Furniture Ordering Information on page 3 before placing your furniture order**



White Pedestals, Standard and Narrow Widths



3 Drawer, Silver Pedestals, Standard & Low Heights



A



A. Steel Low Mobile Pedestal

- 1 Personal drawer 1 File drawer
- 410 x 500 x H495mm

| | | |
|---------|--------|---------|
| O213171 | Silver | £136.10 |
| O213172 | White | £136.10 |

B



B. Steel Narrow Low Mobile Pedestal

- 1 Personal drawer 1 File drawer
- 300 x 500 x H495mm

| | | |
|---------|--------|---------|
| O213191 | Silver | £132.70 |
| O213192 | White | £132.70 |

C



C. Steel Mobile Pedestal

- 2 Personal drawers 1 File drawer
- 410 x 500 x H597mm

| | | |
|---------|--------|---------|
| O213221 | Silver | £161.62 |
| O213222 | White | £161.62 |

D



D. Steel Narrow Mobile Pedestal

- 2 Personal drawers 1 File drawer
- 300 x 500 x H597mm

| | | |
|---------|--------|---------|
| O213231 | Silver | £157.65 |
| O213232 | White | £157.65 |



All CUBE Steel Pedestals Come With Free Drawer Dividers & Pen Tray



CALL US ON 01527 878348



VISIT WWW.FORWARDPRODUCTS.CO.UK



Electronic Safes

- Fine powder coat finish
- 5mm door and 2.5mm body
- Batteries supplied
- Fixing holes and bolts included
- Manufacturer's insurance rating for cash and jewellery
- Lifetime guarantee

| | Internal Size h x w x d (mm) | Capacity Litres | Weight Kg | |
|---------|---------------------------------|--------------------|--------------|---------|
| O213241 | 180 x 300 x 225 | 12 | 28 | £221.01 |
| O213242 | 358 x 215 x 265 | 20 | 42 | £255.99 |
| O213243 | 393 x 323 x 300 | 38 | 75 | £287.79 |

**LIFETIME
GUARANTEE**

Lock styles
may vary -
please check
when ordering

Please
see Important
Furniture Ordering
Information on page
3 before placing
your furniture
order



Fire Resistant Safe

- Fire rated to 1 hour at 1030°C
- Fitted with high security double bitted VDS Class 1 key lock
- Fixing bolts supplied
- Manufacturer's insurance rating for cash and jewellery

| | Internal Size h x w x d (mm) | Capacity Litres | Weight Kg | |
|---------|---------------------------------|--------------------|--------------|---------|
| O213251 | 140 x 270 x 200 | 18 | 20 | £189.21 |
| O213252 | 270 x 370 x 250 | 28 | 40 | £254.40 |
| O213253 | 470 x 370 x 250 | 43 | 56 | £345.03 |



Fire Resistant Media Safe

- A compact data safe for convenient storage of important disks and electronic records
- Magnetic media fully protected

| | Internal Size h x w x d (mm) | Capacity Litres | Weight Kg | |
|---------|---------------------------------|--------------------|--------------|----------|
| O213261 | 245 x 155 x 197 | 7 | 43 | £373.65 |
| O213262 | 380 x 235 x 187 | 17 | 95 | £731.40 |
| O213263 | 495 x 400 x 405 | 80 | 242 | £1300.62 |



Fire Resistant Cupboards

- High security cupboards with double walled construction
- Perfect for storing sensitive exam papers
- Fire resistant to 30 minutes
- 3 way locking system
- Adjustable shelves
- Standard colour grey (RAL7035)
- Internal fittings available at extra cost. Please call for details.

| Code | Internal Size h x w x d (mm) | CapacityWeight | | |
|---------|---------------------------------|----------------|-----|----------|
| | | Litres | Kg | |
| O213271 | 1082 x 506 x 415 | 230 | 71 | £876.09 |
| | 3 Shelves Light Grey | | | |
| O213272 | 1050 x 814 x 415 | 359 | 90 | £1113.00 |
| | 4 Shelves Light Grey | | | |
| O213273 | 1810 x 814 x 415 | 615 | 142 | £1396.02 |
| | 4 Shelves Light Grey | | | |

* Delivery of security cupboards is free of charge to a ground floor location with no more than one step involved

**Other delivery locations will require a site survey and quotation



Please see Important Furniture Ordering Information on page 3 before placing your furniture order

Double Secure Filing Cabinets

- Robust filing cabinets with locking bar system giving high security storage at a budget price
- 100% drawer extension
- 7 year guarantee
- Available in Goose Grey or Coffee Cream

| | | |
|---------|----------|---------|
| O213281 | 2 Drawer | £224.89 |
| O213282 | 3 Drawer | £254.65 |
| O213283 | 4 Drawer | £272.84 |



Please check external dimensions when ordering

Fire Resistant Filing Cabinets

- Light grey filing cabinets
- Fire resistant for 90 minutes
- Individual fire protection for all drawers
- Drop tested to ISO 9001

| | | | |
|---------|----------|-------|----------|
| O213291 | 2 Drawer | 145kg | £960.36 |
| O213292 | 4 Drawer | 266kg | £1399.20 |



UK Manufactured



Please call for bulk prices

Please Specify:

1. Nesting (please call for options)
2. Door colour
3. Carcass colour

Door Colours



Autumn Colour Door Options (available for 305mm wide lockers only)



Single Compartment

- Including top shelf and double coat hook

| | | Single | Nest of 2 (*N2) | Nest of 3 (*N3) |
|----------|-----------------------|---------|-----------------|-----------------|
| O213311* | H1780 x W305 x D305mm | £82.16 | £152.67 | £224.23 |
| O213312* | H1780 x W305 x D380mm | £88.17 | £162.55 | £238.05 |
| O213313* | H1780 x W305 x D460mm | £98.20 | £179.16 | £261.39 |
| O213314* | H1780 x W380 x D380mm | £98.20 | £179.16 | £261.39 |
| O213315* | H1780 x W460 x D460mm | £116.60 | £215.45 | N/A |

* Please specify door colours and carcass colour

Two Compartment

- Including double coat hook per compartment

| | | Single | Nest of 2 (*N2) | Nest of 3 (*N3) |
|----------|-----------------------|---------|-----------------|-----------------|
| O213321* | H1780 x W305 x D305mm | £107.93 | £202.66 | £299.22 |
| O213322* | H1780 x W305 x D380mm | £111.71 | £209.07 | £307.83 |
| O213323* | H1780 x W305 x D460mm | £119.90 | £222.08 | £325.77 |
| O213324* | H1780 x W380 x D380mm | £119.90 | £222.08 | £325.77 |
| O213325* | H1780 x W460 x D460mm | £141.01 | £235.40 | N/A |

* Please specify door colours and carcass colour

Three Compartment

| | | Single | Nest of 2 (*N2) | Nest of 3 (*N3) |
|----------|-----------------------|---------|-----------------|-----------------|
| O213331* | H1780 x W305 x D305mm | £102.76 | £197.03 | £291.28 |
| O213332* | H1780 x W305 x D380mm | £121.20 | £230.86 | £340.52 |
| O213333* | H1780 x W305 x D460mm | £115.22 | £217.30 | £319.38 |
| O213334* | H1780 x W460 x D460mm | £147.96 | £281.22 | N/A |

* Please specify door colours and carcass colour

Four Compartment

| | | Single | Nest of 2 (*N2) | Nest of 3 (*N3) |
|----------|-----------------------|---------|-----------------|-----------------|
| O213341* | H1780 x W305 x D305mm | £109.89 | £211.26 | £312.61 |
| O213342* | H1780 x W305 x D380mm | £132.61 | £253.70 | £374.76 |
| O213343* | H1780 x W305 x D460mm | £123.44 | £233.75 | £344.06 |
| O213344* | H1780 x W380 x D380mm | £138.25 | £261.80 | £385.34 |
| O213345* | H1780 x W460 x D460mm | £160.90 | £307.08 | N/A |

* Please specify door colours and carcass colour

Five Compartment

| | | Single | Nest of 2 (*N2) | Nest of 3 (*N3) |
|----------|-----------------------|---------|-----------------|-----------------|
| O213351* | H1780 x W305 x D305mm | £131.77 | £254.01 | £376.24 |
| O213352* | H1780 x W305 x D380mm | £137.00 | £262.48 | £387.94 |
| O213353* | H1780 x W305 x D460mm | £144.45 | £274.45 | £404.30 |

* Please specify door colours and carcass colour

Six Compartment

| | | Single | Nest of 2 (*N2) | Nest of 3 (*N3) |
|----------|-----------------------|---------|-----------------|-----------------|
| O213361* | H1780 x W305 x D305mm | £151.75 | £293.96 | £436.16 |
| O213362* | H1780 x W305 x D380mm | £154.01 | £296.50 | £438.98 |
| O213363* | H1780 x W305 x D460mm | £165.27 | £315.82 | £466.37 |
| O213364* | H1780 x W380 x D380mm | £165.27 | £315.82 | £466.37 |

* Please specify door colours and carcass colour

Please see Important Furniture Ordering Information on page 3 before placing your furniture order



- All lockers come as standard with Activecoat anti-bacterial powder coating
- All plastic components used in the manufacturing incorporate a silver based anti-bacterial agent
- Activecoat developed in conjunction with Dupont

- Ergonomic Card Holder incorporating a lock cover which protects the lockers from key scratches



- Vent system allows each compartment to 'breathe'



- Even the standard lock has a micro sprung 10 lock featuring a massive 3000 serial combinators



- Every locker has a full strengthener welded into each door to increase security



- Between each compartment the locker has a welded plinth. This makes each compartment totally separate and increases structural rigidity



- High visibility key, making identification easy. Hasp and staple locks for padlocks are also available



All lockers meet:



Please see Important Furniture Ordering Information on page 3 before placing your furniture order

Lock options: Cam lock supplied as standard
Combination Lock 3 Digit, Digital Combination Lock



Combination Lock 3 Digit



Digital Combination Lock

ACTIVECOAT
anti-bacterial technology



- The hard wearing anti-bacterial powder coating for the most stringent hygienic environment

- **Iron Phosphate Key Coat**
This anti-rust, key coat bonds to the steel in readiness for the final active coating

- **Prepared Steel Surface**
Chemical cleaning ensures an ideal surface for further coatings

A Low Lockers Single Tier

- Including top shelf and double coat hook

| | | Single | Nest of 2 (*N2) | Nest of 3 (*N3) |
|----------|-----------------------|--------|-----------------|-----------------|
| O213371* | H1210 x W305 x D305mm | £73.31 | £139.57 | £205.84 |
| O213372* | H1210 x W305 x D460mm | £89.15 | £168.30 | £247.45 |

* Please specify door colours and carcass colour

B Low Lockers Double Tier

| | | Single | Nest of 2 (*N2) | Nest of 3 (*N3) |
|----------|-----------------------|---------|-----------------|-----------------|
| O213381* | H1210 x W305 x D305mm | £98.29 | £189.54 | £280.79 |
| O213382* | H1780 x W305 x D460mm | £110.58 | £211.16 | £311.73 |

* Please specify door colours and carcass colour

C Cube Lockers

| | | Single | Nest of 2 (*N2) | Nest of 3 (*N3) |
|----------|----------------------|--------|-----------------|-----------------|
| O213391* | H305 x W305 x D305mm | £43.64 | £84.93 | £128.09 |
| O213392* | H380 x W380 x D380mm | £51.25 | £99.51 | £149.95 |
| O213393* | H460 x W460 x D460mm | £56.83 | £110.18 | £165.96 |

* Please specify door colours and carcass colour

D Janitors Lockers

- Including top shelf and double coat hook

| | | Single | Nest of 2 (*N2) | Nest of 3 (*N3) |
|----------|-----------------------|---------|-----------------|-----------------|
| O213411* | H1780 x W460 x D460mm | £155.32 | £295.93 | N/A |

* Please specify door colours and carcass colour





Shockbox Laminate Door Lockers

- 10 year guarantee
- Steel carcass with heavy duty 10mm solid grade laminate overlaid doors to withstand vandalism
- Durable 180° hinges
- Anti-bacterial finish
- Supplied with cam lock or hasp and staple lock – please specify when ordering
- End panels and other extras available
- **Please see Important Furniture Ordering Information on page 3 before placing your furniture order**



Shown with optional sloping tops

Locker Configurations

- All lockers 305mm wide x 1780mm high

| | No. of Compartments | Depth (mm) | |
|---------|---------------------|------------|---------|
| O213511 | 1 | 390 | £178.59 |
| O213512 | 1 | 470 | £190.55 |
| O213513 | 2 | 390 | £223.24 |
| O213514 | 2 | 470 | £232.00 |
| O213515 | 3 | 390 | £268.43 |
| O213516 | 3 | 470 | £275.77 |
| O213517 | 4 | 390 | £307.30 |
| O213518 | 4 | 470 | £319.14 |

Optional Extras

| | | |
|---------|--------------------------------------|---------|
| O213520 | Sloping Top Caps – each | £12.29 |
| O213521 | 390mm Deep Straight End Panel | £143.26 |
| O213522 | 470mm Deep Straight End Panel | £174.13 |
| O213523 | 390mm Deep Sloping Top End Panel | £153.73 |
| O213524 | 390mm Deep Sloping Top End Panel | £184.43 |
| O213525 | Aluminium Round Number Cut into Door | £3.47 |

Please Specify:

1. Door colour
2. Body colour

Standard Door Colours*

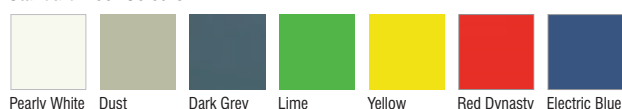

* Other colours available to order

Body Colour



Silver



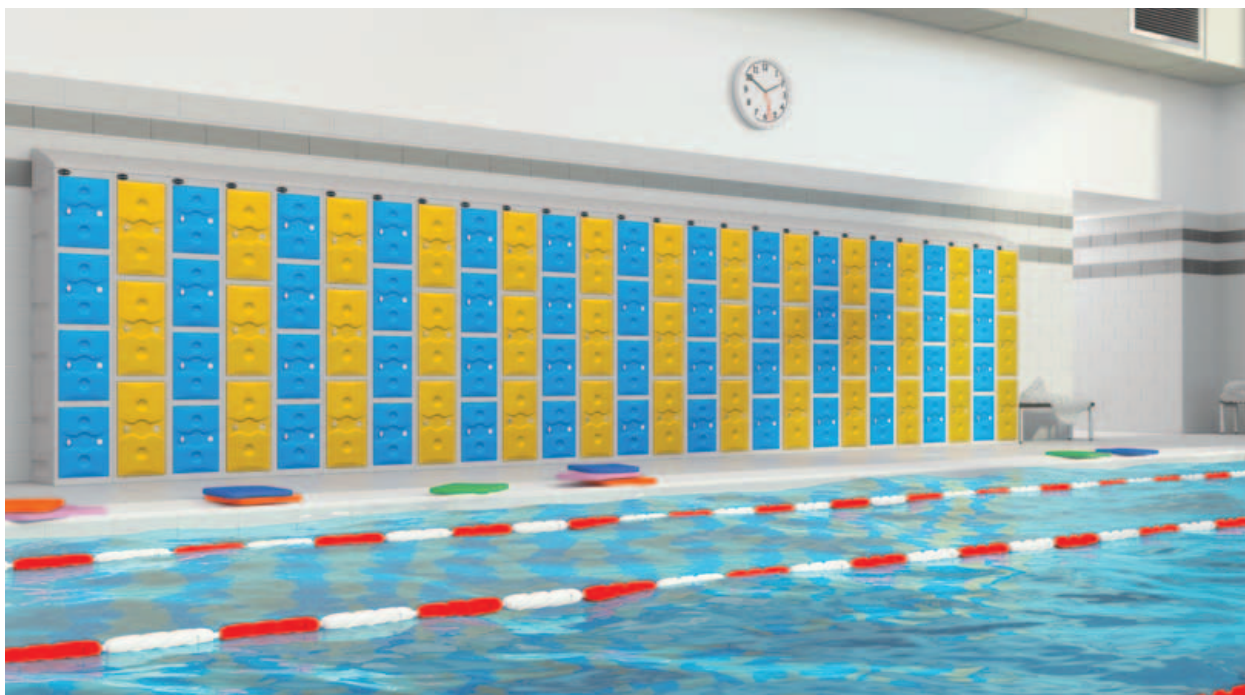

Ultrabox Plastic Lockers

- 10 year guarantee
- Waterproof if sheltered from direct rain
- Vandal resistant
- Anti-bacterial finish
- Supplied with waterproof cam lock or water resistant hasp and staple lock – please specify when ordering
- Other locks available, please call for details
- **Please see Important Furniture Ordering Information on page 3 before placing your furniture order**



Locker Configurations

- All lockers 325mm wide x 450mm deep

| | No. of Compartments | Height (mm) | |
|---------|---------------------|-------------|---------|
| O213530 | 2 | 1800 | £366.38 |
| O213531 | 3 | 1800 | £374.55 |
| O213532 | 4 | 1800 | £374.55 |

Mini Lockers

| | | | |
|---------|--------|-----|---------|
| O213533 | 2 Door | 900 | £232.89 |
| O213534 | 1 Door | 450 | £113.00 |

Optional Extras

| | | |
|---------|---------------------------------|--------|
| O213535 | Sloping Top Caps each | £51.65 |
| O213536 | Adjustable Feet (x4 Per Locker) | £17.04 |



Lockers with Sloping Top Caps

Please Specify:

1. Door colour
2. Body colour

Door Colours

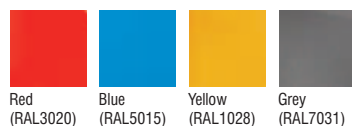

Body Colour



Adjustable Feet



Sloping Top



CALL US ON 01527 878348



VISIT WWW.FORWARDPRODUCTS.CO.UK



12

Dining Furniture

| | |
|-----------------------------------|---------|
| Folding Tables | 244-246 |
| Tilt Top Tables | 247 |
| Frontier Tables | 248-249 |
| Chill & Groove Table & Bench Sets | 250-251 |
| Dining Chairs & Stools | 252-255 |



Flexible Dining Tables

- Transform your hall into a multi-use area effortlessly, in minutes, without the need for heavy lifting
- Choice of three heights for Primary and Secondary usage
- Double sided laminated MDF tops with ultra-tough edges give a water resistant, easy-clean finish for improved cleanliness
- Fully certified by FIRA
- All tables can fit through a standard height doorway (1980mm)
- Tables have a Grey frame
- 16 year frame guarantee
- **Please see Important Furniture Ordering Information on page 3 before placing your furniture order**

Mobile Folding Bench Units

- Rectangular units
- Each unit seats 12-16 depending on pupil age

| | | |
|----------|------------------------|---------|
| D211001* | W3080 x D1400 x H685mm | £750.00 |
| D211002* | W3080 x D1400 x H735mm | £750.00 |

*Please specify top colour, see options below



Top colours available

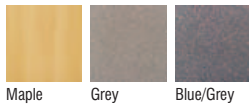

Maple

Grey

Blue/Grey

Mobile Convertible Bench Units

- Each bench seats 4-6 children
- Versatile design means benches can be used for classroom style tables, auditorium type seating or, join two units together to form cafeteria/dining tables
- Lockable castors

| | | |
|----------|-----------------------|---------|
| D211003* | W2435 x D730 x H685mm | £525.00 |
| D211004* | W2435 x D730 x H735mm | £525.00 |

*Please specify top colour, see options below



Convertible Tables - Upright



Two Convertible Tables - Flat



Single Convertible Tables - Flat





Rectangular Mobile Folding Stool Tables

- Perfect where space is at a premium, these tables are flexible, compact and store in minimal areas

| | No. Seats | | | |
|----------|-----------|------------------------|---------|--|
| D211010* | 8 | W2380 x D1500 x H685mm | £735.00 | |
| D211011* | 8 | W2380 x D1500 x H735mm | £735.00 | |
| D211012* | 12 | W3080 x D1500 x H685mm | £813.00 | |
| D211013* | 12 | W3080 x D1500 x H735mm | £813.00 | |
| D211014* | 16 | W3280 x D1500 x H650mm | £938.00 | |

*Please specify top & stool colours, see options below

Shaped Mobile Folding Stool Tables

Round Unit

| | No. Seats | | |
|----------|-----------|------------------------|---------|
| D211020* | 8 | W2130 x D2155 x H685mm | £861.78 |
| D211021* | 8 | W2130 x D2155 x H735mm | £861.78 |

Octagonal Units

| | No. Seats | | |
|----------|-----------|------------------------|---------|
| D211022* | 8 | W2130 x D2155 x H685mm | £813.00 |
| D211023* | 8 | W2130 x D2155 x H735mm | £813.00 |

*Please specify top & stool colours, see options below



8 Seat Rectangular Table



Round Table



Octagonal Table



Octagonal Table - Folded

Top colours available

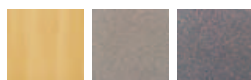

Maple Grey Blue/Grey

Stool colours available



Apple Green Orange Blueberry Blue Lilac Green Wine Black Red Yellow



CALL US ON 01527 878348



VISIT WWW.FORWARDPRODUCTS.CO.UK



Concept Folding Tables and Stacking Benches

- Very popular aluminium framed tables with durable laminated tops
- Fold flat design for easy storage
- 5 year guarantee
- **Please see Important Furniture Ordering Information on page 3 before placing your furniture order**



| Folding Tables | | Size W x Dmm | Approx weight | A Buffet 76cm (30") | B Adult 70cm (27.5") | C Junior 64cm (25") | D Infant 58cm (23") | E PreSchool 55cm (21.5") | F Nursery 51cm (20") | 1-4 | 5+ |
|----------------|-------------|---------------|---------------|------------------------|-------------------------|------------------------|------------------------|-----------------------------|-------------------------|---------|---------|
| D211211 | Rectangular | 920 x 610 | 6.75kg | | • | • | • | • | • | £84.25 | £82.81 |
| D211212 | Rectangular | 920 x 690 | 7.25kg | | • | • | • | • | • | £86.31 | £84.52 |
| D211213 | Rectangular | 920 x 760 | 7.25kg | | • | • | • | • | • | £89.44 | £87.58 |
| D211214 | Rectangular | 1220 x 610 | 8.00kg | • | • | • | • | • | • | £96.41 | £94.40 |
| D211215 | Rectangular | 1220 x 690 | 8.25kg | • | • | • | • | • | • | £98.82 | £96.77 |
| D211216 | Rectangular | 1220 x 760 | 9.50kg | • | • | • | • | • | • | £102.60 | £100.47 |
| D211217 | Rectangular | 1520 x 610 | 9.75kg | • | • | • | • | • | • | £103.55 | £101.39 |
| D211218 | Rectangular | 1520 x 690 | 10.25kg | • | • | • | • | • | • | £110.04 | £107.75 |
| D211219 | Rectangular | 1520 x 760 | 11.25kg | • | • | • | • | • | • | £113.87 | £111.51 |
| D211221 | Rectangular | 1830 x 480 | 11.00kg | • | • | • | • | • | • | £109.21 | £106.95 |
| D211222 | Rectangular | 1830 x 610 | 11.50kg | • | • | • | • | • | • | £120.13 | £117.64 |
| D211223 | Rectangular | 1830 x 690 | 12.00kg | • | • | • | • | • | • | £122.62 | £119.35 |
| D211224 | Rectangular | 1830 x 760 | 13.00kg | • | • | • | • | • | • | £126.58 | £123.60 |
| D211225 | Round | Diameter 1220 | 20.00kg | • | • | • | • | • | • | £217.60 | £212.00 |
| D211226 | Round | Diameter 1520 | 27.50kg | • | • | • | • | • | • | £253.80 | £248.00 |

*Please specify height and top colour

| Stacking Benches | | Size W x Dmm | Approx weight | A Buffet 48cm (19") | B Adult 43cm (17") | C Junior 38cm (15") | |
|------------------|-----------------|--------------|---------------|------------------------|-----------------------|------------------------|---------------|
| D211231 | Rectangular | 1220 x 250 | 5.00kg | • | • | • | £64.17 £62.84 |
| D211232 | Rectangular | 1520 x 250 | 5.75kg | • | • | • | £72.50 £70.98 |
| D211233 | Rectangular | 1830 x 250 | 6.75kg | • | • | • | £78.16 £76.54 |
| D211234 | Bench Skate Set | | 3.00kg | | | | £79.52 £77.86 |

*Please specify height and top colour

Trolleys

- Save time and effort with these easy to use trolleys
- Easily pass through standard doorways
- Locking Castors

| | | |
|---------|--|---------|
| D211241 | Trolley taking up to 7 Rectangular Tables | £239.57 |
| D211242 | Trolley taking up to 14 Rectangular Tables | £342.35 |
| D211243 | Trolley taking up to 6 Round Tables | £396.29 |

Please Specify:

1. Table/bench height
2. Table/bench colour

Concept Top & Bench Colour Options



PU Edge Tilt Top Dining Tables

- Comprehensive range of attractive multi-use tilt top tables, perfect where space is at a premium
- Easy to use tilt and close mechanism
- Advanced impact resistant, waterproof textured PU edges
- 4 lockable castors for safety
- 5 year guarantee
- 4 heights available giving flexibility for all age ranges
- **Please see Important Furniture Ordering Information on page 3 before placing your furniture order**



Octagonal Tilt Table - W1200mm

| | 1-2 | 3-14 | 15+ |
|----------|---------|---------|---------|
| D211251* | £252.61 | £234.24 | £229.64 |
| D211252* | £252.61 | £234.24 | £229.64 |
| D211253* | £252.61 | £234.24 | £229.64 |
| D211254* | £252.61 | £234.24 | £229.64 |

* Please specify top colour, edge colour & frame colour



Irregular Octagonal Tilt Table - W1380 x D1000mm

| | 1-2 | 3-14 | 15+ |
|----------|---------|---------|---------|
| D211261* | £254.45 | £235.94 | £231.32 |
| D211262* | £254.45 | £235.94 | £231.32 |
| D211263* | £254.45 | £235.94 | £231.32 |
| D211264* | £254.45 | £235.94 | £231.32 |

* Please specify top colour, edge colour & frame colour



Oval Tilt Table W1610 x D900mm

| | 1-2 | 3-14 | 15+ |
|----------|---------|---------|---------|
| D211271* | £346.14 | £320.96 | £314.67 |
| D211272* | £346.14 | £320.96 | £314.67 |
| D211273* | £346.14 | £320.96 | £314.67 |
| D211274* | £346.14 | £320.96 | £314.67 |

* Please specify top colour, edge colour & frame colour



Medium Rectangular Tilt Table - W1200 x D900mm

| | 1-2 | 3-14 | 15+ |
|----------|---------|---------|---------|
| D211281* | £221.24 | £205.15 | £201.12 |
| D211282* | £221.24 | £205.15 | £201.12 |
| D211283* | £221.24 | £205.15 | £201.12 |
| D211284* | £221.24 | £205.15 | £201.12 |

* Please specify top colour, edge colour & frame colour



Large Rectangular Tilt Table - W1500 x D900mm

| | 1-2 | 3-14 | 15+ |
|----------|---------|---------|---------|
| D211291* | £268.45 | £248.93 | £244.05 |
| D211292* | £268.45 | £248.93 | £244.05 |
| D211293* | £268.45 | £248.93 | £244.05 |
| D211294* | £268.45 | £248.93 | £244.05 |

* Please specify top colour, edge colour & frame colour

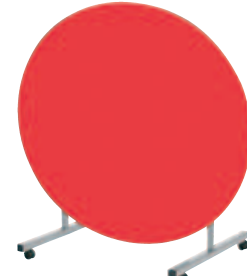

Circular Tilt Table - D1200mm

| | 1-2 | 3-14 | 15+ |
|----------|---------|---------|---------|
| D211311* | £250.06 | £231.87 | £227.33 |
| D211312* | £250.06 | £231.87 | £227.33 |
| D211313* | £250.06 | £231.87 | £227.33 |
| D211314* | £250.06 | £231.87 | £227.33 |

* Please specify top colour, edge colour & frame colour

Please Specify:

1. Top colour
2. Edge colour
3. Frame colour

Laminate Top Colours



PU Edge Information:

Incredibly tough, PU edging is moulded to the MDF core meaning that it cannot be prised or picked away

PU Edge Colours

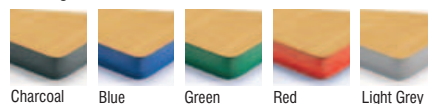

Frame Colours



CALL US ON 01527 878348



VISIT WWW.FORWARDPRODUCTS.CO.UK



Frontier Tables - Bases

- Sturdy range of table bases
- Choose from stylish stainless steel or black slimline design
- See following page for the accompanying tops
- Adjustable feet suitable for most floor finishes
- 3 year guarantee
- **Please see Important Furniture Ordering Information on page 3 before placing your furniture order**

Please call to book a site consultation

See next page for top options

Dining Bases 730mm high



D211321



D211322



D211323



D211324

Poseur Bases - 1050mm High



D211325



D211326



D211327



D211328

| Code | Base Type | Base Width | Max. Top Sizes | | Price |
|---------|--------------------------------------|------------|----------------|---------------|---------|
| | | | Round | Square | |
| D211321 | Dining Base - Medium Black | 450mm | 900mm | 700 x 700mm | £93.00 |
| D211322 | Dining Base - Large Black | 600mm | 1300mm | 1000 x 1000mm | £133.36 |
| D211323 | Dining Base - Medium Stainless Steel | 460mm | 800mm | 700 x 700mm | £126.05 |
| D211324 | Dining Base - Large Stainless Steel | 600mm | 1200mm | 1100 x 1100mm | £176.10 |
| D211325 | Poseur Base - Medium Black | 450mm | 900mm | 700 x 700mm | £100.57 |
| D211326 | Poseur Base - Large Black | 600mm | 1300mm | 1000 x 1000mm | £140.93 |
| D211327 | Poseur Base - Medium Stainless Steel | 460mm | 800mm | 700 x 700mm | £133.36 |
| D211328 | Poseur Base - Large Stainless Steel | 600mm | 1200mm | 1100 x 1100mm | £183.67 |



Frontier Tables - Tops

- Hardwearing range of tops to go with Frontier bases on previous page
- Tested for severe contact use
- Other sizes and colours also available, please call for details
- **Please see Important Furniture Ordering Information on page 3 before placing your furniture order**

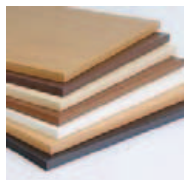

Call for
free
samples



Laminated Tops

- 25mm durable laminated tops
- Scratch resistant and heat resistant to 180°F
- 6 attractive colours
- Other sizes and colours also available, please call for details

Square Tops

| | | |
|---------|-------------|---------|
| D211331 | 500 x 500mm | £49.24 |
| D211332 | 600 x 600mm | £57.89 |
| D211333 | 700 x 700mm | £75.47 |
| D211334 | 800 x 800mm | £86.02 |
| D211335 | 900 x 900mm | £101.33 |

Rectangular Tops

| | | |
|---------|--------------|---------|
| D211341 | 1000 x 500mm | £55.13 |
| D211342 | 1000 x 600mm | £70.87 |
| D211343 | 1100 x 700mm | £124.27 |
| D211344 | 1200 x 600mm | £100.90 |
| D211345 | 1200 x 700mm | £124.97 |
| D211346 | 1200 x 800mm | £125.78 |

Circular Tops

| | | |
|---------|-----------------|---------|
| D211351 | 600mm Diameter | £64.76 |
| D211352 | 700mm Diameter | £87.59 |
| D211353 | 800mm Diameter | £108.15 |
| D211354 | 900mm Diameter | £124.97 |
| D211355 | 1000mm Diameter | £150.13 |
| D211356 | 1200mm Diameter | £174.21 |

Laminated Top Colour Options

Please Specify:

Top colour



Beech



Oak



Walnut



Wenge



White



Black

Premium Moulded Tops

- Extremely durable table tops with a completely sealed moulded edge
- Suitable for indoor and outdoor use
- 10 stylish colour options
- Please call for colour samples
- **Please see Important Furniture Ordering Information on page 3 before placing your furniture order**



Other sizes
and colours
available -
please call for
options

Square Tops

| | | |
|---------|-------------|--------|
| D211361 | 600 x 600mm | £62.38 |
| D211362 | 700 x 700mm | £80.01 |
| D211363 | 800 x 800mm | £94.95 |

Rectangular Tops

| | | |
|---------|--------------|---------|
| D211371 | 1100 x 700mm | £119.57 |
|---------|--------------|---------|

Circular Tops

| | | |
|---------|----------------|--------|
| D211381 | 600mm Diameter | £55.08 |
| D211382 | 700mm Diameter | £67.91 |
| D211383 | 800mm Diameter | £75.55 |

Please Specify:

Top colour

Moulded Top Colour Options



City



Arizona



Blanc



Noir

Premium Moulded Top Colour Options (price POA)



Alu



Orange



Rouge



Vert



Cassis



Wenge

* Not available in 1200mm diameter circular ** Not available in 900mm, 1000mm or 1200mm diameter circular



CALL US ON 01527 878348



VISIT WWW.FORWARDPRODUCTS.CO.UK



Chill Primary Canteen Table & Bench Sets

Fantastic solution for primary school dining.

- Available in sizes to suit infant and junior schools
- Encourages communal dining
- Solid 18mm MDF tops with a high pressure laminate finish and durable PU edges
- Each code is one set which includes one table and two benches
- Chunky 30mm crushed bent frame
- Stackable up to 3 high
- Three tables and six benches neatly stack away when not in use
- Made in the UK with a 5 year warranty

| | Table Dimensions (mm) L x W x H | Bench Dimensions (mm) L x W x H | |
|----------------------|------------------------------------|------------------------------------|---------|
| Infant Height | | | |
| D212391* | 1600 x 750 x H530 | 1400 x 300 x H310 | £515.32 |

| | Table Dimensions (mm) L x W x H | Bench Dimensions (mm) L x W x H | |
|----------------------|------------------------------------|------------------------------------|---------|
| Junior Height | | | |
| D212392* | 1600 x 750 x H640 | 1400 x 300 x H380 | £515.32 |

* Please specify top colour, edge colour, frame colour & bench colour

Each set includes 1 Table and 2 Benches

Please Specify:

1. Top colour
2. Edge colour
3. Frame colour
4. Bench vinyl colour

Laminate Top Colour



PU Edge Colours

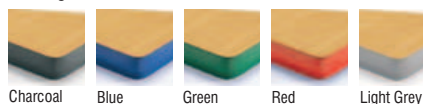

Frame colour - supplied in speckled light grey if not specified

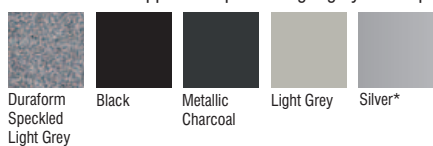

Bench Vinyl Colour

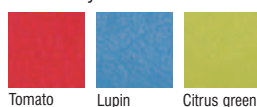

*Silver frame available at an extra cost.





Groove Secondary Canteen Table & Bench Sets

- Stylish & robust 25mm white laminated tops with white BURO edge
- Chunky 40 x 40mm box frame
- Vibrant choice of frame colours available
- Each code is one set which includes one table and two benches
- Benches store underneath the table for a tidy environment



| Code | Table Dimensions (mm) L x W x H | Bench Dimensions (mm) L x W x H | |
|----------|------------------------------------|------------------------------------|---------|
| D212393* | 1600 x 800 x H760 | 1400 x 400 x H450 | £588.09 |
| D212394* | 1800 x 800 x H760 | 1600 x 400 x H450 | £628.35 |
| D212395* | 2000 x 800 x H760 | 1800 x 400 x H450 | £687.25 |
| D212396* | 2200 x 800 x H760 | 2000 x 400 x H450 | £749.51 |

* Please specify frame colour

Each set includes 1 Table and 2 Benches

Please Specify:

1. Frame colour

Frame Colour



Pastel Orange

Pastel Violet

Soft Blue

Soft Lime

Tangy Green

Telemagenta

Turquoise

Laminate Top Colour



White

BURO Edge Colour



White



CALL US ON 01527 878348



VISIT WWW.FORWARDPRODUCTS.CO.UK



Switch Chair and Stool

- Stylish polypropylene breakout chair with robust chrome-plated steel frame
- Fibreglass reinforced seat and back
- Additional upholstered seat pad available
- Chairs stack 8 high and stools stack 4 high
- 5 year guarantee
- **Please see Important Furniture Ordering Information on page 3 before placing your furniture order**

Switch Chair

- W540 x D450 x SH460mm

| | | 1-5 | 6-29 | 30+ |
|---------|--------------|--------|--------|--------|
| D211481 | Switch Chair | £60.34 | £58.38 | £56.41 |

Switch Stool

- W500 x D500 x SH760mm

| | | 1-5 | 6-29 | 30+ |
|---------|--------------|---------|---------|---------|
| D211482 | Switch Stool | £111.51 | £107.88 | £104.24 |

Extras - Upholstered Seat Pad

- Price based on Advantage fabric, see page 258 for options

| | | 1-5 | 6-29 | 30+ |
|---------|--|--------|--------|--------|
| D211483 | | £40.74 | £37.77 | £36.50 |



Please Specify:

Seat colour



Dream Chair

- Elegant new polypropylene chair with ergonomically shaped back
- Stackable up to 8 high
- Robust construction - tested for heavy contact use
- Suitable for indoor and outdoor use
- **Please see Important Furniture Ordering Information on page 3 before placing your furniture order**

| | | 1-5 | 6-29 | 30+ |
|---------|-------------|--------|--------|--------|
| D211491 | Dream Chair | £62.10 | £57.75 | £55.27 |



Please Specify:

Seat colour





Maestro Chair

- Durable, flexible and ergonomic high density seating for stimulating spaces
- Contemporary and comfortable, perfect for halls, cafeterias, libraries and classrooms
- 10 year guarantee
- Stacks 38 high on transport dolly
- Chrome frame
- Seat pad price is for Advantage fabric, please see page 258 for options
- **Please see Important Furniture Ordering Information on page 3 before placing your furniture order**



| | 1-5 | 6-29 | 30+ |
|------------------------------|---------|--------|--------|
| D211501 Maestro Chair | £75.55 | £72.05 | £69.95 |
| D211502 Upholstered Seat Pad | £25.76 | £24.80 | £24.57 |
| D211503 Transport Dolly | £236.63 | n/a | n/a |



Please Specify:

Seat colour



CALL US ON 01527 878348



VISIT WWW.FORWARDPRODUCTS.CO.UK



Breeze Chair

- Durable and comfortable, the Breeze is an exciting dining and breakout chair
- Made from UV resistant reinforced polypropylene
- Stacks up to 10 high
- Tested to EN1729 parts 1 and 2
- 5 year guarantee
- W500 x D510 x SH460mm

| | | 1-5 | 6-29 | 30+ |
|---------|--------------|--------|--------|--------|
| D211521 | Breeze Chair | £52.68 | £46.89 | £44.78 |

Please Specify:

Seat colour

Breeze Chair Colour Options

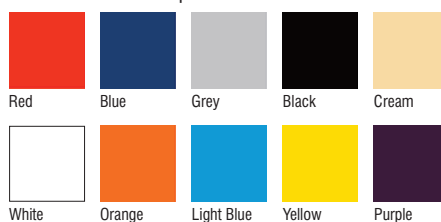

Swing Chair

- Modern new breakout chair range with unique features
- 2 base options to suit numerous applications
- 4 leg and skid frame chairs have heavy duty chrome stackable frames
- 2 year guarantee
- Tested for severe contact use
- 8 eye-catching colours available



Swing Four Leg

- W580 x D510 x SH450mm

| | 1-5 | 6-29 | 30+ |
|---------|--------|--------|--------|
| D211532 | £68.43 | £63.95 | £58.19 |

Swing Skid Frame

- W580 x D510 x SH450mm

| | 1-5 | 6-29 | 30+ |
|---------|--------|--------|--------|
| D211531 | £73.13 | £68.35 | £62.20 |

Please Specify:

Seat colour

Swing Chair Colour Options



Please see Important Furniture Ordering Information on page 3 before placing your furniture order





Curve Dining Chair

- Attractive plywood shell chair with solid chrome plated frame
- Beech finish supplied as standard, other finishes available, see bottom of page
- 3 year guarantee
- Protective rubber feet for hard floors
- Stackable up to 4 high
- W500 x D460 x SH450mm

| | | 1-5 | 6-29 | 30+ |
|---------|-----------------|--------|--------|--------|
| D211561 | Stain Finish | £66.32 | £61.68 | £59.02 |
| D211562 | Laminate Finish | £97.41 | £90.59 | £86.69 |

Please see Important Furniture Ordering Information on page 3 before placing your furniture order



Standard Beech Stain



Beech Stacked



Zebrano Laminate



Special Polyrey Laminate

Curve Stool

- Sleek bar stool to match Curve chair
- Chrome plated skid base with footrest and rear frame support
- Beech finish supplied as standard, see below for further colour options
- 3 year guarantee
- Protective anti-skid feet
- W532 x D524 x SH745mm

| | | 1-5 | 6-29 | 30+ |
|---------|-----------------|---------|---------|---------|
| D211571 | Stain Finish | £131.37 | £122.18 | £116.92 |
| D211572 | Laminate Finish | £158.61 | £147.50 | £141.16 |



Please Specify:

Seat colour

Standard Stain Colours



Premium Laminate Colours**

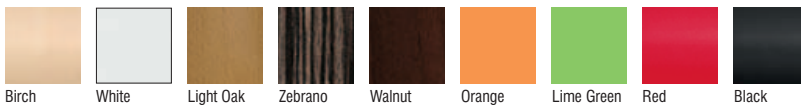

*Beech supplied as standard
 **Other colours available.
 Please call for details



CALL US ON 01527 878348



VISIT WWW.FORWARDPRODUCTS.CO.UK



13

Fabrics

| | |
|-------------------|-----|
| Advantage | 258 |
| Main Line Plus | 259 |
| Blazer | 260 |
| Aquarius | 261 |
| Linetta | 262 |
| Corrosion & Code | 263 |
| Just Colour Vinyl | 264 |
| Vita Vinyl | 265 |
| Cara Screen | 266 |
| Lucia Screen | 267 |

Advantage - Standard Fabric for Office Chairs and Conference Chairs

- Advantage is the UK's top selling Low Hazard seating fabric
- Its high performance durability comes from its blend of 30% wool and 70% gymlene - a synthetic fibre originally developed for use in broadloom carpets
- It is rated at 75,000 Martindale abrasion cycles

For a wider range of fabric options, please call us today.

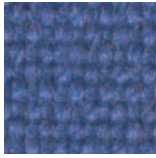

Adriatic

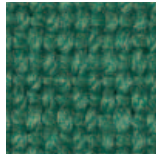

Aqua

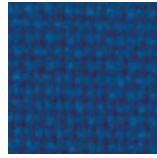

Cobalt

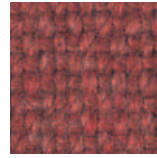

Cranberry

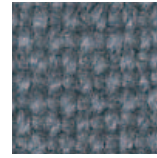

Granite

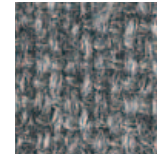

Mineral

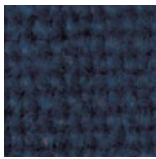

Nightshade

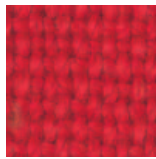

Red

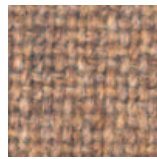

Sandvale

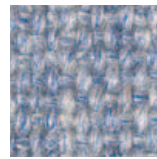

Sea Blue

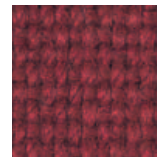

Wine

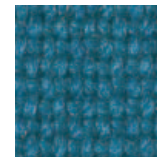

Delta Blue



Turquoise



Charcoal



Grape



Leaf

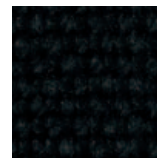

Black



Graphite



Pewter



Damson



Tawny

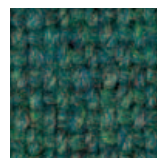

Persian

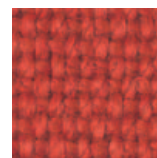

Cinnamon

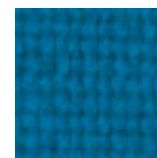

Largo



Aztec



Beetroot

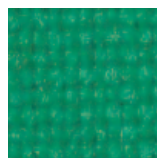

Oasis

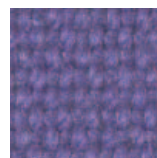

Purple



Fox

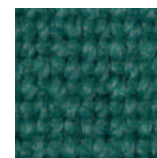

Teal

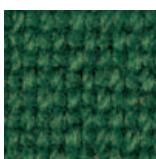

Shamrock

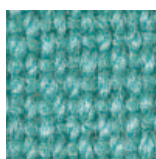

Kingfisher

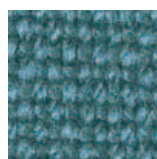

Riviera

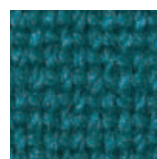

Trident

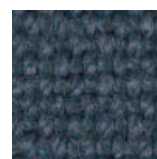

Fjord

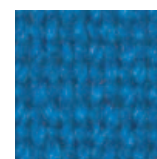

Clipper



Raspberry



Peat

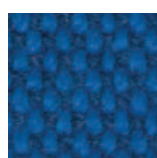

Hobbit

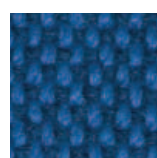

Trent

- Flammability: Low hazard BS 7176.
- Abrasion resistance: 75,000 cycles.
- Composition: 30% pure new wool, 70% gymlene.
- Maintenance: Vacuum regularly, wipe clean with a damp cloth.
- Colour Matching: Batch to batch variations in shade may occur within commercial tolerance.

Due to limitations in the printing process when fabric is shown photographically, we recommend that you ask for actual fabric samples before ordering.



Mainline Plus - Standard Fabric for Sofas and Soft Seating

- One of the most popular seating fabrics in the Camira collection which has sold over 30 million metres since launch
- Available in an extensive colour palette, this versatile plain weave fabric gives a smart appearance to most seating styles

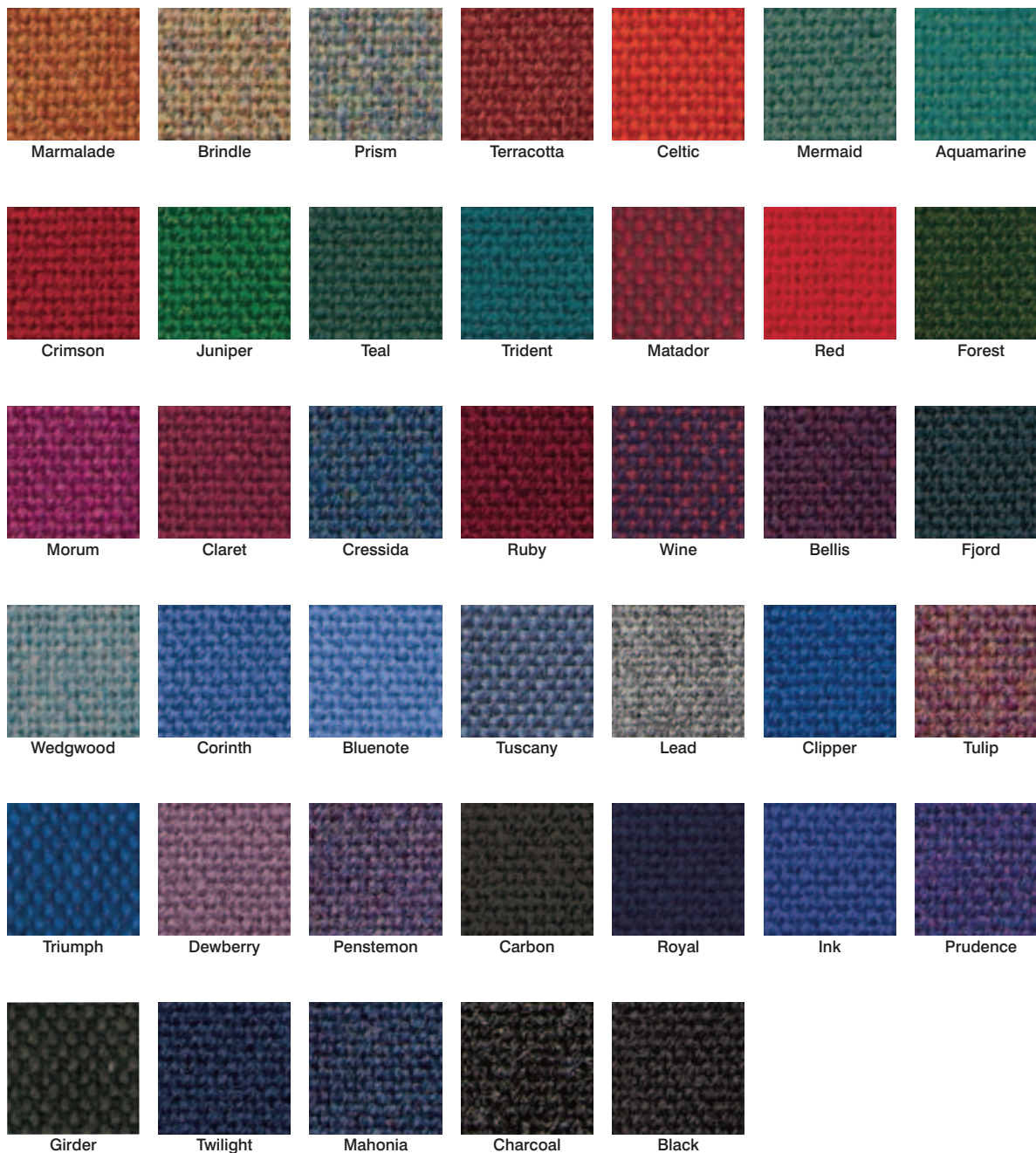

Due to limitations in the printing process when fabric is shown photographically, we recommend that you ask for actual fabric samples before ordering.



CALL US ON 01527 878348



VISIT WWW.FORWARDPRODUCTS.CO.UK

Blazer - Premium Fabric for All Seating Ranges - Add 35% to Prices

- Blazer is a pure new wool upholstery fabric with a billiard cloth felted finish
- Created from 100% Laneve branded wool, its origin can be traced back to the individual sheep farms on South Island, New Zealand. Laneve promises wool integrity and complete chain of custody
- Blazer is certified to the EU Ecolabel



Due to limitations in the printing process when fabric is shown photographically, we recommend that you ask for actual fabric samples before ordering.



Aquarius - Premium Fabric for all Seating Ranges - Add 35% to Prices

- Aquarius is a tried and tested, versatile crepe weave fabric that is suitable for task chairs and soft seating
- It's made from 100% natural wool, which is not only rapidly renewable but also fully bio-degradable
- The colour palette offers a great balance of subdued organic shades and confident brights



Due to limitations in the printing process when fabric is shown photographically, we recommend that you ask for actual fabric samples before ordering.



CALL US ON 01527 878348



VISIT WWW.FORWARDPRODUCTS.CO.UK

Linetta – Anti-Microbial Fabric for All Seating Ranges – Add 15% to Prices

Linetta is anti-microbial, bleach cleanable, stain resistant and waterproof. It has also been tested and is effective against viruses including Covid-19! This is through a protection system called 'Aguaguard 365'

Specifications:

- Flame retardant - BS7176 Crib 5, BS EN 1021-1:2006 1&2, BS5852 Crib 5, IMO Annex 1 Part 8.
- Anti-bacterial/Anti-fungal - Resistant to microbial or fungal growth including Salmonella, E Coli and MRSA.
- Waterproof - Hydrostatic Head BS3424 > 1 metre.
- Martindale - Severe Contract > 100,000.
- Stain resistant - Excellent stain removal has been observed for grease, ink, blood, urine, coee, iodine, betadine, ketchup, chewing gum, chocolate, grape juice.
- Composition - 100% Treated polyester.
- Breathable - Moisture vapour permeable.

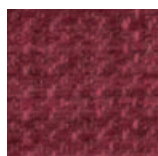

Plum

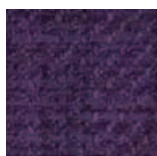

Violet



Silver



Light Grey



Slate



Cream



Salmon



Olive



Grape



Mint



Light Blue



Steel



Nutmeg



Sand



Burnt Orange



Lime



Purple



Duck Egg



Denim



Charcoal



Truffle



Gold



Red



Orchid

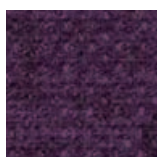

Damson



Teal



Midnight

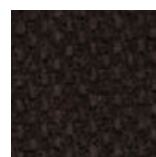

Black



Chocolate



Mustard

Linetta uses state of the art anti-bacterial fabric technology Aguaguard 365

- A safe anti-bacterial protection system for upholstery fabrics, effective against viruses including Covid-19. Whilst research indicates viruses and bacteria survive longer on hard surfaces, soft surfaces like textiles can provide a large hosting area and benefit their carryover.
- It is comprised of a patented and registered silver technology (small silver particles are potent antibacterial and antiviral agents) and a pending patent fatty vesicle technology that acts as a booster to the silver technology that physically destroys viruses.

AguaGuard365 is:

- Harmless to the skin and body and uses a minimum of active ingredients
- EU BPR (Biocidal Products Regulation) and EU REACH compliant.
- Carries Bluesign, EPA, OekoTex and ZDHC (Zero Discharge Of Hazardous Chemicals) approval and certification.

Due to limitations in the printing process when fabric is shown photographically, we recommend that you ask for actual fabric samples before ordering.



Corrosion - Premium Fabric for All Seating Ranges - Add 45% to Prices

- Printed onto wool blend fabric, Synergy, the rusting surface of Corrosion is broken up with geometric triangles, exploring the mix of negative space, rust and hard cut shapes.



Task seating



Soft seating



Cigarette & Match



Year guarantee



Etch



Entropy



Oxidise



Tarnish



Enrich



Erode

Code - Premium Fabric for All Seating Ranges - Add 45% to Prices

- Code is a luxurious worsted wool reminiscent of the old Savile Row suiting cloths updated for today's digital age
- The fabric echoes modern technology by featuring barcode inspired stripes which run horizontally across the fabric due to the large pattern repeat
- The range presents darker, explorative shades alongside bright, bold and playful colours



Task seating



Soft seating



Cigarette & Match



Year guarantee



Scanner



Dots



Matrix



Dash



Data

Due to limitations in the printing process when fabric is shown photographically, we recommend that you ask for actual fabric samples before ordering.



CALL US ON 01527 878348



VISIT WWW.FORWARDPRODUCTS.CO.UK

Just Colour Vinyl - Vinyl for All Seating Ranges - Add 15% to Prices

Just Colour harmonizes with both contemporary and traditional interiors. The broad palette encompasses modern neutrals, warm classics to vivid bright colours.

Designed to withstand the rigorous demands of both heavy domestic and contract upholstery, Just Colour is suitable for a wide variety of applications.

- Flame Retardancy: BS5852 Ignition Source 5, BS7176 Medium Hazard, S.I. 1988 No. 1324 schedule 4&5, EN1021-1&2, CS-25, FMVSS 302 and IMO A 652 (16)
- Abrasion: 100,000+
- Antimicrobial and antifungal, independent testing has verified that Just Colour is effective at reducing the spread of MRSA, E.coli and other similar bacteria and fungi
- 3 year warranty



Due to limitations in the printing process when fabric is shown photographically, we recommend that you ask for actual fabric samples before ordering.



Vita Vinyl - Vinyl for All Seating Ranges - Add 15% to Prices

- Vita is a leather-look vinyl, with a subtle surface grain effect and full matt appearance
- It provides maximum protection for heavy duty end-use areas in sectors such as contract, healthcare and public transport
- It is available in a broad palette of 23 considered colourways
- Vita does not contain phthalate plasticisers or heavy metals, yet remains soft, stretchy and pliable
- Vita's special and highly durable top coat is suitable for cleaning with soapy water and upholstery shampoo, and will also stand up to bleach or alcohol cleaners for maximum hygiene
- 5 year warranty



Due to limitations in the printing process when fabric is shown photographically, we recommend that you ask for actual fabric samples before ordering.



CALL US ON 01527 878348



VISIT WWW.FORWARDPRODUCTS.CO.UK

Cara Standard Screen Fabric

- Cara is a plain weave panel fabric available in 32 commercial colourways
- One of our most popular vertical surface fabrics
- Cara is used extensively on desk screens, wallsides and on pin board

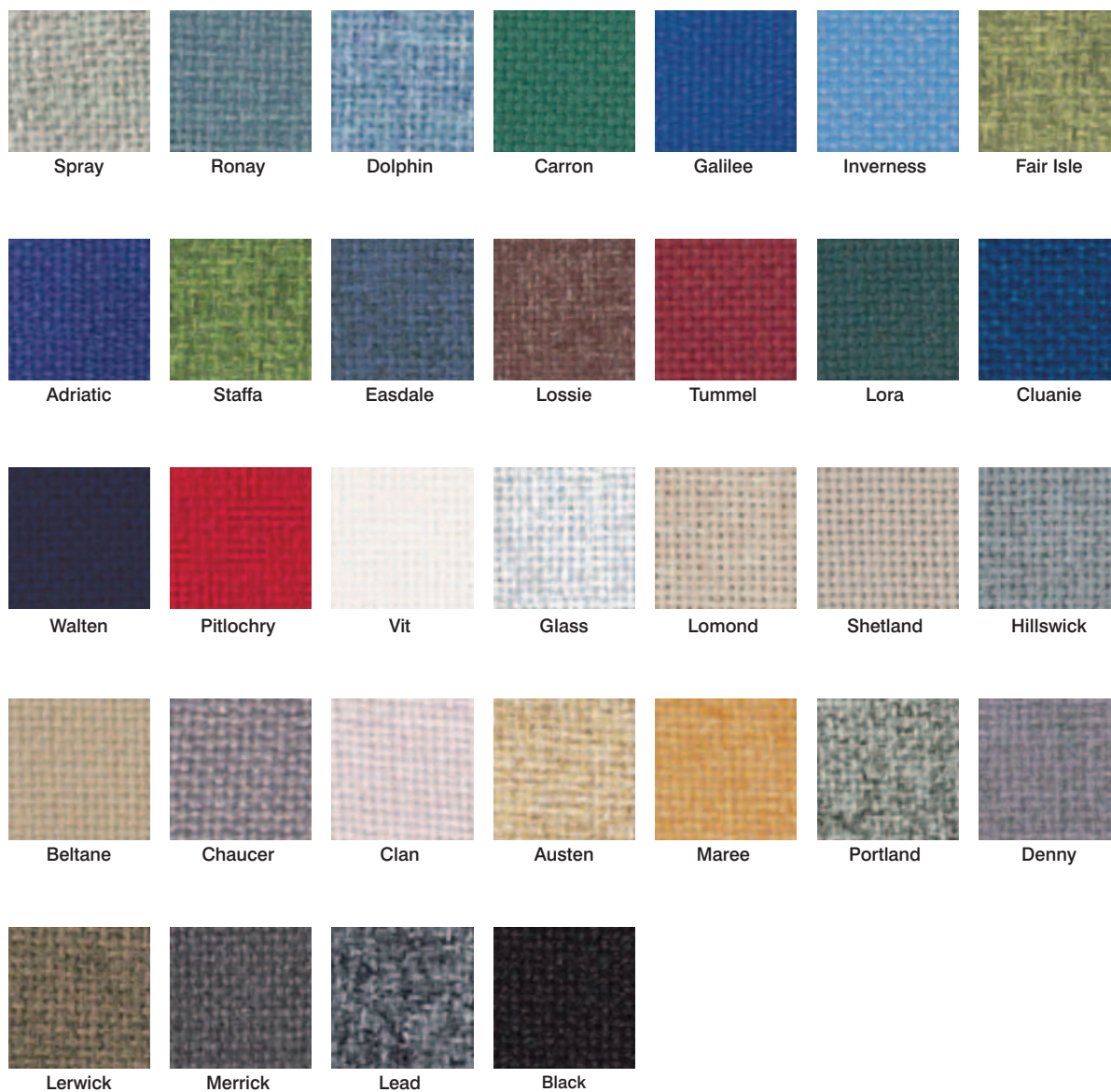

Due to limitations in the printing process when fabric is shown photographically, we recommend that you ask for actual fabric samples before ordering.



Lucia - Premium Screen Fabric - Add 10% to Prices

- An ever popular crepe weave synthetic panel fabric
- Manufactured from 100% recycled polyester saving virgin raw materials and for a reduced environmental footprint. With a non lustrous appearance, it has a bold and bright colour palette
- Lucia is certified to the EU Ecolabel

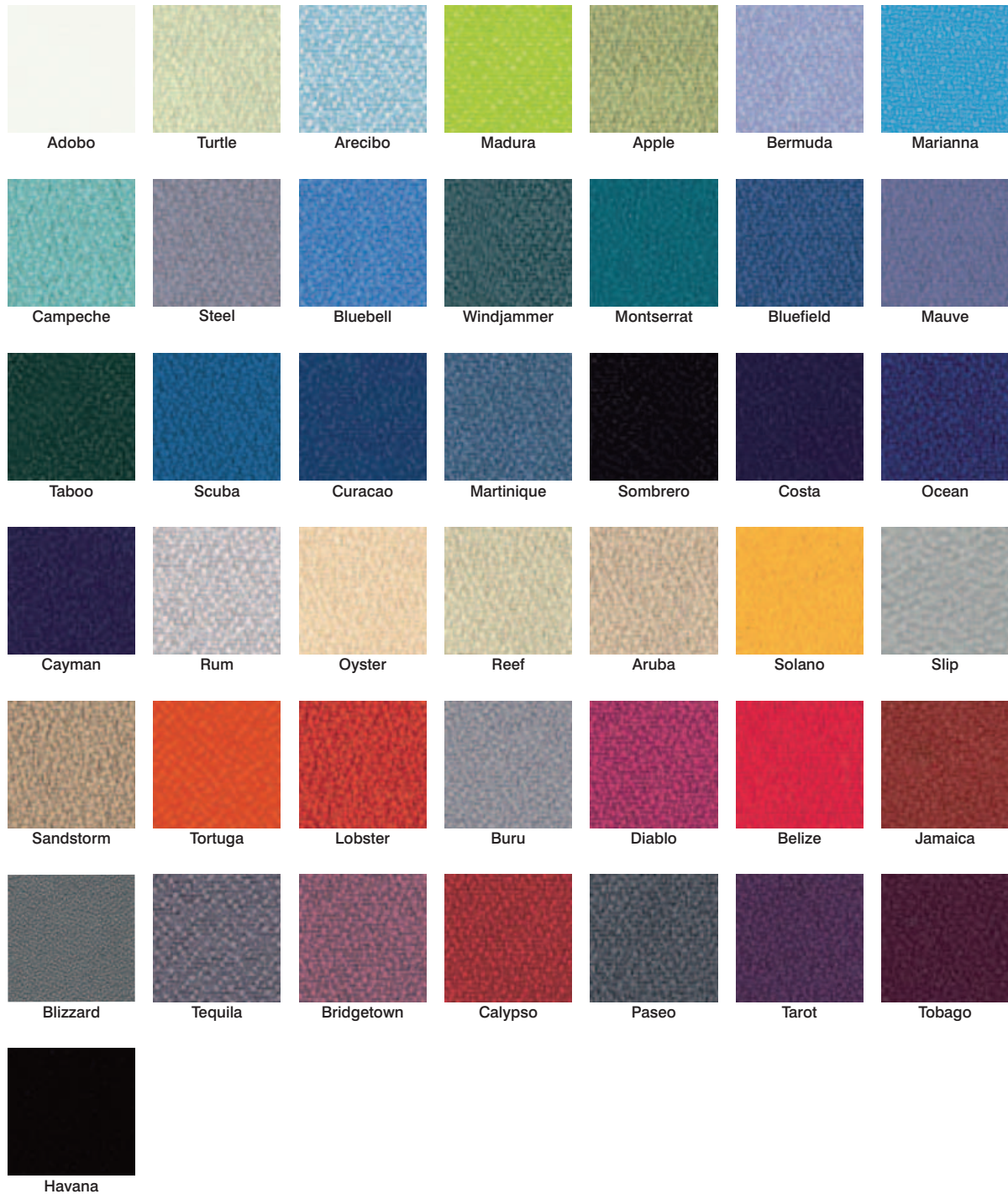

Due to limitations in the printing process when fabric is shown photographically, we recommend that you ask for actual fabric samples before ordering.



CALL US ON 01527 878348



VISIT WWW.FORWARDPRODUCTS.CO.UK

INDEX

A

| | |
|-------------------------------|-------------------------|
| A3 Paper Storage Unit..... | 73 |
| Adjustable Height Tables..... | 45,49, 85-86,184-185 |
| Art Storage Units..... | 72-73 |

B

| | |
|------------------------------|---|
| Back Care Seating..... | 138-139 |
| Barriers..... | 95 |
| Bean Bags..... | 90,167 |
| Beech Cantilever Furniture.. | 172-177,223 |
| Beech Tables & Chairs..... | 84-85, 170-180,184-186,204-218,223-224 |
| Bench Desking..... | 178-181 |
| Big Book Holder..... | 87 |
| Bin Storage..... | 87 |
| Boardroom Tables..... | 204,210-215 |
| Bookcases..... | 56,66,69,71,87,198,201,226 |
| Breakout Seating..... | 88-89, 160-162,164-165 |

C

Cabinets

| | |
|-------------------------|--|
| Filing..... | 201,225,226,230-231,237 |
| First Aid..... | 119 |
| Key..... | 119 |
| Cable Management..... | 181,185,189 |
| Café Seating..... | 252-255 |
| Cantilever Chairs..... | 11,22-23,129, 132,134,137,140-141,144-146 |
| Cantilever Desking..... | 172-177,223 |
| Carrel Units..... | 49 |
| Certificate Frames..... | 116 |
| Chair Trolley..... | 15,17,144,253 |

Chairs By Name

| | |
|-----------------|---------|
| Abele..... | 144 |
| Abingdon..... | 146,147 |
| Aero Stool..... | 22 |
| Affinity..... | 14 |
| Ascott..... | 146 |
| Atlanta..... | 130,161 |
| Balmoral..... | 137 |
| Bianca..... | 145 |
| Brodsworth..... | 146 |
| Carlisle..... | 126 |

| | |
|------------------------------------|---------------|
| Castelo..... | 130 |
| Catania..... | 140 |
| Classic..... | 18,25 |
| Conquest..... | 137 |
| Dumbell..... | 6 |
| Eco..... | 14 |
| Elegance..... | 136 |
| EN One Piece Polypropylene..... | 10 |
| EN Polypropylene..... | 11 |
| Ergoform..... | 20 |
| Excel..... | 134-135 |
| Fyvie..... | 129 |
| Giovanni..... | 136 |
| Harlech..... | 124 |
| Helmsley..... | 128 |
| Hype..... | 15,19,25 |
| Inspire..... | 16 |
| Lorenzo..... | 147 |
| Maestro..... | 253 |
| Miranda..... | 125 |
| Modena..... | 145 |
| Penrith..... | 133 |
| Postura Plus..... | 7 |
| Rochester..... | 133 |
| Sevilla..... | 143 |
| Stockholm Posture..... | 138 |
| Stokesay..... | 131 |
| Storm..... | 13,25 |
| Swivel..... | 18-19,124-139 |
| Titan High Chair..... | 24 |
| Titan One Piece Polypropylene..... | 8 |
| Titan Polypropylene..... | 9,19 |
| Toledo..... | 128 |
| Trebuchet..... | 139 |
| Valencia..... | 142 |
| Vaneto..... | 127 |
| Venice..... | 141 |
| Verona..... | 141 |
| Vigo..... | 142 |
| Vita..... | 140 |
| Wentworth..... | 132 |
| Whitley..... | 126 |
| Zing Stool..... | 23 |

Chairs By Type

| | |
|-----------------------|--|
| Back Care Range..... | 138-139 |
| Breakout Seating..... | 88-89, 160-162,164-165 |
| Cantilever..... | 11,22-23,129, 132,134,137,140-141,144-146 |
| Classroom..... | 4-26 |

| | |
|---------------------------------------|--------------------------------|
| Conference Chairs..... | 140-147,222 |
| Dining..... | 250-255 |
| Early Years..... | 85,88-91 |
| Fabric Ranges..... | 256-267 |
| Folding..... | 17 |
| High Chairs..... | 24-26 |
| IT Chairs..... | 18-19 |
| Manager Swivel..... | 136-137 |
| Meeting..... | 140-147 |
| Mesh Back Swivel..... | 125,130,132,134 |
| Modular..... | 150-154,162-164 |
| One Piece Polypropylene..... | 7,8,10 |
| Operator..... | 124-129,222 |
| Pouffe..... | 90,91,150-151,159 |
| Skid Base Classroom..... | 7,9,11,13 |
| Sofas..... | 152-153, 156-157,159-165 |
| Soft..... | 148-167 |
| Stacking..... | 7,8,10,12-16,253 |
| Stools..... | 20-24 |
| Tamperproof IT..... | 18 |
| Task..... | 127,130-136,139 |
| Tub Chairs..... | 156-159 |
| Classroom Chairs..... | 4-26 |
| Classroom Furniture..... | 4-91 |
| Classroom Stools..... | 20-24 |
| Classroom Storage Units..... | 51-81 |
| Classroom Tables..... | 27-50 |
| Craft..... | 42-43 |
| Crushbent Frame..... | 28-31,34 |
| Early Years..... | 35,84-86 |
| Exam Desks..... | 48 |
| Express Delivery Tables..... | 33 |
| Flower Shaped..... | 86 |
| Heavy Duty..... | 38-39 |
| Height Adjustable..... | 45 |
| Locker Top Desks..... | 46 |
| MDF Edge..... | 28-29, 32-33,42-43,45-46,48 |
| Premium..... | 34-41,43-45,48 |
| Project..... | 42-43 |
| PU Edge..... | 30-34,36-45 |
| Shaped..... | 40-41,85-86 |
| SmartTop Desks..... | 50 |
| Study Carrels..... | 49 |
| Teacher's Desks..... | 47 |
| Themed..... | 86 |
| Tray Tables..... | 32 |
| Welded Frame..... | 28-33,35-37,42-43 |
| Cloakroom Equipment & Benches..... | 78,89,238-241 |



Clocks..... 118,119
 Coat Hooks..... 78,89
 Coat Peg Units..... 78,89
 Coffee Tables..... 153,157,163,216-219
 Coloured Edge Storage Units..... 68-69
 Conference Furniture.... 140-147,204-215
 Conference Seating..... 140-147,222
 Conference Tables..... 204-205,210-215
 Covid Testing Booths & Pods..... 94,96-97
 Craft Tables..... 42-43
 Crushbent Frame Tables.....28-31,34,42

Cupboards

Art.....72-73,77
 Classroom Double Door.... 57,61,67,69
 Coloured Edge..... 69
 Dressing Up.....77
 Fire Resistant..... 237
 Glass Door..... 196,198-199
 Lockable Wooden..... 57,61,67,69
 Office..... 196-202,226
 Safes..... 236
 Sliding Door..... 65,196,198
 Steel Lockable..... 227,232,237
 Tambour Cupboards.....202,227,233
 Steel..... 227,232-233,237
 Tray Storage..... 54-65,68,70-80
 Wooden.....57,61,67,69,196-202,226
 Wooden Lockable..... 57,61,67,69

D

Desks/Desking

Accessories..... 188-191
 Bench Desking..... 178-181
 Cantilever..... 172-177,223
 Classroom..... 46,47,48
 Craft.....42-43
 Exam..... 48
 Flip Top..... 48,208,246
 Folding..... 48,208,246
 Height Adjustable..... 45,184-185
 Locker Top..... 46
 Meeting Ends..... 186
 Panel End..... 170-171,224
 Screens..... 95,98-99,192-195
 Teacher's..... 47
 Tilt Top..... 48,208,246

Dining

Chairs..... 252-255
 Folding Tables..... 244-247
 Folding Stool Tables..... 244-245
 Poseur Tables..... 248-249
 Stools..... 252,255
 Table Bases & Tops.....248-249
 Table & Bench Sets..... 250-251
 Tilt Top Tables.....44,247

Display Kits, Light..... 117
 Double Door Cupboards..... 57,61,67,69,
 196-202,226-,227,232-233,237
 Dressing Up Cupboard..... 77

Drywipe

Boards.....102-109,116
 Esels..... 106-107
 DT Workbenches.....50

E

Early Years

Chairs..... 85,88-91
 Seating..... 85,88-91
 Storage..... 87
 Tables..... 84,85,86
 Esels, Drywipe..... 106-107
 EN One Piece Polypropylene Chair..... 10
 EN Polypropylene Chairs..... 11
 Exam Chairs..... 17
 Exam Desks..... 48
 Executive Conference Seating..... 146
 Executive Office Seating..... 136-137
 Express Delivery Tables..... 33,223-224

Express Ranges

Chairs..... 222
 Desks..... 223-224
 Filing..... 225-227
 Storage..... 226-227

F

Fabric Swatches..... 256-267
 Filing Cabinets - Steel..... 226,
 230-231,237
 Filing Cabinets - Wooden..... 201,225
 Fire Resistant Cupboards..... 237
 Fire Resistant Filing Cabinets..... 237
 Fire Resistant Safes..... 236
 First Aid Cabinets..... 119
 Fixed Pedestals.....183,225
 Flip Top Tables..... 44,209,247
 Floor Standing Screens..... 192-193
 Folding Benches..... 244-246
 Folding Chairs..... 17
 Folding Tables..... 48,208,246

G

Gratnells Trays..... 53
 Gratnells Tray Storage Units..... 54-65,
 68,70-71,73-80

H

Healthcare

Barriers..... 95
 Covid Testing Pods..... 94
 Screens..... 95,98-99
 Testing Booths..... 96-97
 Heavy Duty Classroom Tables..... 38-39
 Height Adjustable Tables..... 45,184-185
 High Chairs..... 24-26

I

Interior Plants..... 120-121
 IT Desking..... 49,50
 IT Seating.....18-19

J

Jumbo Tray Storage Units..... 62

K

Key Cabinets..... 119

L

Laptop Storage & Charging Units..... 81
 Library Storage Unit..... 75-77
 Light Display Kits..... 117
 Linked Benching..... 178-181
 Lockable Cupboards..... 57,61,67,69,
 196-202,226-227,232,237
 Locker Top Desks..... 46
 Lockers..... 75,238-241

M

Magnetic Whiteboards..... 102,103,106-109
 Manager Seating..... 136-137,146
 Maple Storage..... 74-78
 MDF Edge Tables.....28-29,32-33,
 42-43,45-46,48
 Meeting Chairs..... 140-147
 Meeting Tables..... 204-215
 Mesh Back Swivel Chairs..... 125,130,
 132,134
 Metal Classroom Storage Units..... 79-81
 Mobile Pedestals..... 182,225,227,235
 Mobile Tray Storage Units..... 54-60,
 62-65,68,70-71,73-77,80



Modular Seating..... 150-154,162-164
 Modular Breakout Seating..... 150-151,
 162,164
 Modular Storage Units..... 70-71
 Modular Tables..... 40-41
 Multidrawer Units..... 231

N

Noticeboards

Combination..... 116
 Cork..... 114,116
 EcoColour..... 112-113
 Framed..... 110,111-113
 Magnetic..... 114
 Tamperproof..... 110,111,113
 Unframed..... 110,111-113

O

Office Accessories..... 100-121
 Office Chairs..... 122-139,222

Office Furniture

Back Care Seating..... 138-139
 Bench Desking..... 178-181
 Boardroom Tables..... 204,205,
 210-215
 Bookcases..... 198,201,226
 Cable Management..... 181,185,189
 Cantilever Desking..... 172-177,223
 Coffee Tables..... 153,157,163,216-219
 Conference Chairs..... 140-147,222
 Conference Tables..... 204-215
 Cupboards..... 196,198,199-202,
 226,227,232-233,237
 Desking..... 170-180,184-186,223-224
 Executive..... 136,137,146,174-177
 Fabric Ranges..... 256-267
 Filing Cabinets - Steel..... 226,
 230-231,237
 Filing Cabinets - Wooden..... 201,225
 Flip Top Tables..... 44,209,247
 Lockers..... 238-241
 Manager Swivel Chairs..... 136-137
 Mesh Back Swivel Chairs..... 125,130,
 132,134
 Meeting Ends..... 186
 Meeting Chairs..... 140-147,222
 Meeting Tables..... 204-215
 Modular Chairs..... 150-154,160-164
 Multidrawer Units..... 231
 Operator Chairs..... 124-129,222
 Panel End Desking..... 170-171,224

Pedestals..... 182-183,225,227,235
 Pigeon Hole Units..... 187,199
 Plants..... 120-121
 Screens..... 95,98-99,192-195
 Side Filer Units..... 197,225
 Sofas..... 152-153,156-157,159-165
 Steel Cupboards..... 227,232-233,237
 Steel Pedestals..... 227,235
 Swivel Chairs..... 124-139
 Tables..... 184-185,204-219
 Tambour Cupboards..... 202,227
 Task Chairs..... 127,130-136,139
 Training Tables..... 206-209
 Tub Chairs..... 156-159
 Office Plants..... 120-121
 Office Soft Seating..... 122-167
 Operator Chairs..... 124-129
 Outdoor Plants..... 121

P

Panel End Desking..... 170-171,224
 Paper Storage Units..... 72-73
 Pedestals..... 182-183,225,227,235
 Pen Trays..... 188
 Photo & Certificate Frames..... 116
 Pigeon Hole Units..... 187,199
 Plants..... 120-121
 Polypropylene Classroom Chairs..... 7-16,
 20-25
 Poster Frames..... 116
 Postura Plus Chairs..... 7
 Posture Seating..... 7,138-139
 Pouffes..... 90,91,150-151,159
 Premium Classroom Tables..... 34-41,
 43-45,48
 Premium Tray Units..... 54-57
 Project Table..... 42-43
 PU Edge Tables..... 30-34,36-45
 Puzzle Tables..... 41

R

Reading & Writing Centre..... 109
 Reception Seating..... 150-166

S

Safes..... 236
 Screens..... 95,98-99,192-195
Seating:
 Bean Bags..... 90,167

Beech..... 85
 Breakout..... 88-89,160-162,
 164-165
 Café..... 252-255
 Classroom..... 4-26
 Conference Chairs..... 140-147
 Dining..... 244-245,250-255
 Early Years..... 85,88-91
 EN Chairs..... 10-11
 Fabric Ranges..... 256-267
 Folding..... 17
 High Chairs..... 24-25
 IT Chairs..... 18-19
 Manager Swivel Chairs..... 136-137
 Meeting Chairs..... 140-147
 Mesh Back Swivel Chairs..... 125,
 130,132,134
 Modular..... 150-154,162-164
 Postura Plus Chairs..... 7
 Pouffe..... 90,91,150-151,159
 Operator Chairs..... 124-129,222
 Segment..... 91,150-151,153
 Sofas..... 152-153,156-157,159-165
 Soft..... 148-167
 Staffroom..... 152-165
 Stools..... 6,7,20-24,159,
 245,252,255
 Stools - Dining..... 252,255
 Swivel Chairs..... 18-19,124-139,222
 Task Chairs..... 127,130-136,139
 Titan Chairs..... 8,9,19
 Titan High Chair..... 24
 Tub Chairs..... 156-159
 Shaped Tables..... 40-41,85-86
 Shockbox Lockers..... 240
 Side Filer Units..... 197,225
Sienna Range
 Accessories..... 188-191
 Bench Desking..... 178-181
 Coffee Tables..... 216-218
 Conference Tables..... 210-215
 Desking..... 170-177
 Flip Top Tables..... 209
 Meeting Ends..... 186
 Meeting Tables..... 204-205
 Pedestals..... 182-183
 Storage..... 196-203
 Training Tables..... 206-209
 Skid Base Chairs..... 7,9,11,13,140,
 155,166,255
 Sliding Door Cupboard..... 65,196,198
 Snap Display Poster Frames..... 116
 Sofas..... 152-153,156-157,159-165
 Spectrum Heavy Duty Table..... 38-39
 Stacking Chairs - Classroom..... 7,8,
 10,12-16



Stacking Chairs - Conference.....140-144,
222
Staffroom Seating..... 152-165
Steel Cupboards..... 227,232-233,237
Steel Lockers..... 238-240
Steel Pedestals..... 227,235
Steel Storage Accessories..... 234
Steel Storage..... 226-239
Stools - Dining..... 252,255
Stools..... 20-24,252,255

Storage

Art..... 72-73
Bookcases..... 56,66,69,71,
87,198,201,226
Classroom..... 53-81
Coloured Edge..... 68-69
Cupboards..... 57,61,67,69,77,
196-202,226,227,232-234,237
Early Years..... 87
Filing Cabinets - Steel..... 226,227,
230-231,237
Filing Cabinets - Wooden..... 201,225
Glass Door Cupboard..... 196,198-199
Gratnells Trays & Units..... 52-65,
68,70-71,73-80
Jumbo Tray Units..... 62
Library..... 75,87
Lockable Wooden Cupboards..... 57,
61,67,69,196-202,226
Lockers..... 75,238-241
Maple Range..... 74-78
Metal Tray Units..... 79-80
Mobile Bin..... 87
Mobile Tray Unit..... 54-60,62-65,
68,70-77,80
Multidrawer Units..... 231
Pedestals..... 182-183,225,
227,235
Pigeon Hole Units..... 187,199
Safes..... 236
Sliding Door Cupboard.... 65,196,198
Steel Cupboards..... 227,232-233,237
Tambour Cupboards..... 199,
202,227,233
Tray Storage Units..... 52-65,68,
70-80
Wooden Lockable Cupboards..... 57,
61,67,69,196-202,226
Study Carrel Units..... 49
Swivel Chairs..... 18-19,124-139,222

T

Tables

Bases & Tops..... 248-249

Beech..... 84-85,170-180,184-186,
204-218,223-224
Bench..... 178-181
Boardroom..... 204-205,210-215
Boat Shaped..... 212-215
Cantilever..... 172-177,223
Classroom..... 27-41,45-48
Coffee..... 153,157,163,
216-219
Conference..... 204-215
Craft..... 42-43
Crushbent Frame..... 28-31
Early Years..... 84-86
Early Years, Beech..... 84-85
Express Delivery Classroom..... 33
Flip Top..... 44,209,247
Flower Shaped..... 85,86
Folding, Dining..... 244-247
Folding, Meeting..... 209
Heavy Duty Classroom..... 38-39
Height Adjustable..... 45,49,85,
86,184-185
MDF Edge..... 28-29,32-33,
42-43,45-46,48
Meeting..... 204-215
Poseur..... 248-249
Premium Classroom..... 34-41,
43-45,48
Project..... 42-43
PU Edge..... 30-34,36-45
Puzzle..... 41
Shaped..... 40-41
Teacher's Desk..... 47
Themed Early Years..... 85-86
Tilt Top..... 44,209,247
Tops..... 249
Training..... 206-209
Tray..... 32
Workbenches..... 42-43
Welded Frame..... 28-33,35-37,42-43
Tambour Cupboards - Steel..... 227,233
Tambour Cupboards - Wooden..... 197,
199,202
Task Chairs..... 127, 130-136, 139
Teacher's Desks..... 47
Themed Tables..... 85-86
Tilt Top Tables..... 44,209,247
Titan Chairs..... 8,9,19,24
Tray Tables..... 32
Tray Storage Units..... 52-65,68,
70-80

Trolleys

Exam Chairs..... 17
Exam Desks..... 48
Tub Chairs..... 156-159

U

Ultrabox Plastic Lockers..... 241

W

Welded Frame Tables..... 28-33,
35-37,42-43

Whiteboards

Boards..... 102-109
Coloured Edge..... 104,105
Easels..... 106-109
Eco Friendly..... 104
Revolving..... 108
Tilting..... 108
Wooden Cupboards..... 57,61,67,
69,196-202,226
Wooden Locker Top Desks..... 46

Workstations

Cantilever Leg..... 172-175,223
IT Mobile..... 49
Panel End..... 170-171,224
Technology Workbench..... 42-43





John Knight Interiors is the fitted furniture and projects division of Forward Products, specialising in furniture solutions for Schools, Colleges and Universities.

Our strapline "Designs that work in practice" encapsulates our mission – we provide well designed fitted furniture packages that work for students and educators alike.

We aim to support you at step of the process during the project, with open and honest communication right from the planning stage through to project management and completion.

Our services include:

- Initial site survey by experienced consultant
- Free CAD space planning by design experts
- Full installation service
- Project management



Areas we specialise in:

- Science laboratories
- Food Technology rooms
- Reception desks
- Teaching walls
- IT Suites
- Most other areas - please contact us for more details on enquiry@johnknightinteriors.com or call us on 01527 834798





Tel: 01527 878348

Email: sales@forwardproducts.co.uk

Web: forwardproducts.co.uk

Post: Redcliffe House, Sherwood Rd,
Bromsgrove, B60 3DR



Follow us @[ForwardProducts](https://www.instagram.com/ForwardProducts)